

QMX: QRP Labs Multimode Xcvr (transceiver)

Operating manual, firmware 1.00_011, 29-Nov-2023

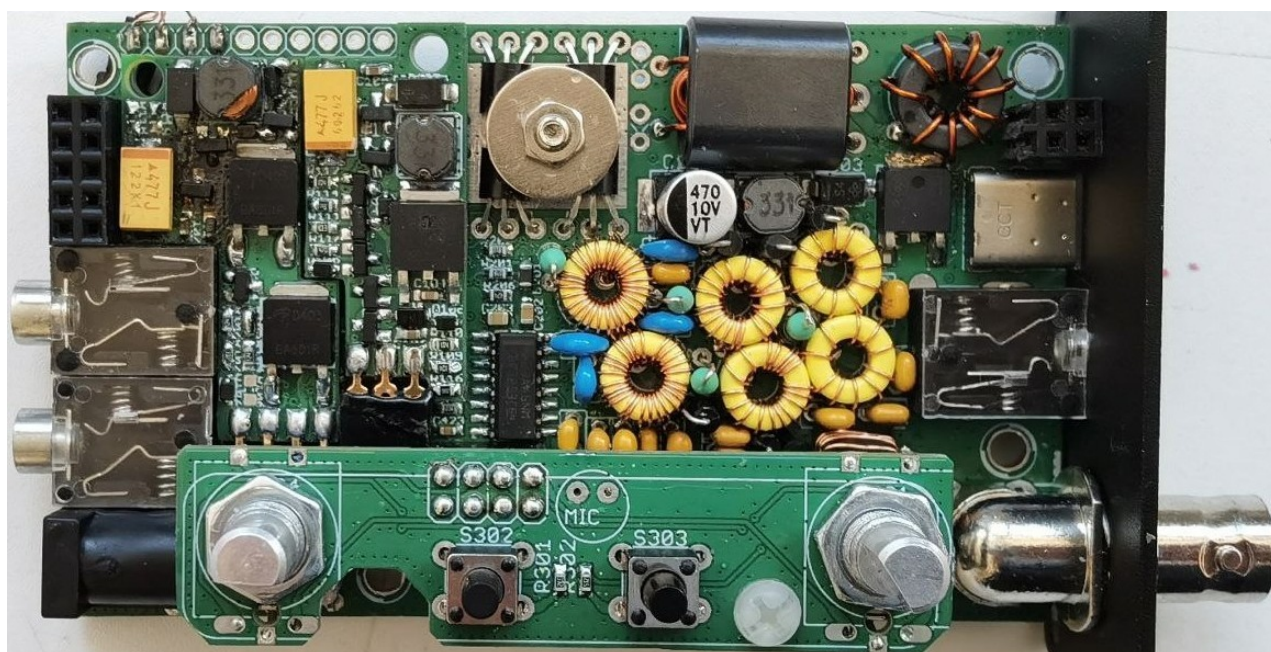

Contents

1. Overview of features.....	4
2. Connectors.....	7
3. Display elements.....	10
4. Operator Controls.....	11
4.1 Tune rate.....	12
4.2 Keyer speed.....	12
4.3 RIT.....	13
4.4 VFO mode.....	13
4.5 VFO A/B operations.....	14
4.6 Frequency Presets.....	14
4.7 Automated message transmission mode.....	14
5. Menu System.....	15
5.1 Saving current operating parameters (VFO frequency etc).....	16
5.2 Types of configuration menu item.....	16
5.3 Editing a configuration menu parameter.....	16
5.4 Editing a LIST parameter.....	17
5.5 Editing a BOOLEAN parameter.....	17
5.6 Editing a NUMBER parameter.....	17
5.7 Editing a TEXT parameter.....	18
5.8 Frequency presets menu.....	19
5.9 Messages menu.....	19
5.10 Keyer menu.....	21
5.11 CW Decoder menu.....	24
5.12 Digi interface.....	26
5.13 Beacon menu.....	29
5.14 Display/controls menu.....	35
5.15 Protection menu.....	39
5.16 System config.....	40
5.17 Hardware tests.....	45
5.18 Factory Reset.....	46
5.19 Update firmware.....	47
6. Operating QMX on digital modes.....	48
7. Firmware Update procedure.....	55
8. Terminal Applications.....	59
8.1 PC terminal emulator.....	59
8.2 Entering terminal applications mode.....	60
8.3 Exiting terminal applications mode.....	60
8.4 Configuration menu.....	61
8.5 Band configuration.....	62
8.6 Hardware tests menu.....	64
8.6.1 Audio filter sweep.....	64
8.6.2 RF filter sweep.....	65
8.6.3 Image sweep.....	67
8.6.4 SWR sweep.....	68
8.6.5 Diagnostics.....	69
8.6.6 GPS viewer.....	71
8.7 PC and CAT menu.....	73

8.7.1 System config.....	74
8.7.2 Input Analysis.....	74
8.7.3 CAT command test.....	78
8.7.4 CAT monitor.....	83
8.7.5 Log file.....	83
8.8 System menu.....	86
8.9 Exit terminal.....	86
9. Resources.....	87
10. Document Revision History.....	87

1. Overview of features

QMX is a high performance, five-band multi-mode 5W QRP transceiver kit, which implements a sophisticated SDR receiver in a 168MHz 32-bit ARM Cortex M4 microcontroller (STM32F446). Most of the features are implemented digitally in firmware, and the feature set is continuing to be expanded by ongoing firmware development. Please refer to the later section on planned future functionality. This section provides a brief summary of the features to explore and enjoy.

QMX is highly portable

The small size and very low receive current consumption (as low as 80mA) are key features of QMX, making it an ideal transceiver for portable operations including SOTA and POTA activations.

QMX is a standalone CW transceiver, or a Digimodes modem

You can use QMX on its own, plugging in earphones, power supply, paddle and antenna and operating CW; or, you can connect it to a PC with a single USB-C cable, to provide CAT control and Digital audio to the PC and use it with WSJT-X or other programs for single-tone FSK digital modes (not suitable for PSK31 and phase shift modes until SSB is implemented).

Synthesised VFO with rotary encoder tuning

The VFO is an Si5351A or MS5351M synthesiser chip, configured by the microcontroller. A rotary encoder tunes the VFO, with a variable tuning rate. The radio includes two VFOs, A and B. You can swap from one to the other, copy the contents of the active VFO to the inactive one, or operate Split (Transmit on VFO A, receive on VFO B). There is also a RIT mode offering a receive offset of up to +/- 9,999Hz. The CW offset is also adjustable, and CW-R (sideband swap) mode is supported.

Memory features

There are 16 frequency presets for your favourite operating frequencies. Each frequency preset can be edited in the configuration menu, or loaded/saved into/from the currently operating VFO.

Message mode

The firmware supports storage of 12 messages. Each of these are 50 characters long. A single button click shows the list of messages to send. Message sending can be configured to send just once, or a configurable number of times, or indefinitely repeating. The interval between transmissions is also configurable. The message feature can be useful, for example, for setting up a repeated CQ call with a pause between repeats, during which you can listen for any answers. As soon as you touch the key the message sending is canceled. When message sending is in progress an 'M' character appears near the top right of the display.

CW Keyer

Operation with a Straight key is possible, but the firmware also includes an Iambic keyer, for connection of a paddle. The keyer can be configured to operate in Iambic modes A or B, or Ultimatic mode. The keyer speed is variable via a single button press during operation.

Full or semi break-in

With its solid-state, microcontroller operated transmit/receive switch, the radio can operate cleanly in full break-in "QSK" mode, or if you prefer, semi-break in.



CW Decoder

A CW decoder operates in the microcontroller. This can be useful on air, particularly for newcomers to CW, though it is never anywhere near as good in QRM or weak signal conditions as a good CW operator using the wet-ware between his ears. The decoder has a “Practice” mode too, for you to practice your CW sending without actually generating RF. The decoder can also be used to conveniently enter text in the message storage, or for configuration of any of the other menu items. The decoder can also be switched off if desired.

CW, FSKCW or WSPR Beacon mode

A beacon is included too, and this can be configured to operate in CW, FSKCW or WSPR mode. Owners of the QRP Labs Ultimate-series weak signal mode transmitter kits will be familiar with the operation of WSPR. A GPS module such as the QRP Labs QLG2 GPS receiver kit can optionally be connected to this CW transceiver kit to provide frequency and time discipline, as well as setting the Maidenhead locator (from latitude and longitude) that is encoded in the WSPR message.

S-meter and Battery voltage

An S-meter and battery voltage indicator can be enabled for display on the LCD. These are both configurable to your needs. The battery voltage indicator would be useful if you intend to operate the radio portable on battery power. Battery voltage range warning can be configured and prevention of transmit if out of range.

SWR measurement

Built-in SWR bridge always in-line, continuously measures SWR and power output; these can be configured to show on the display, and a configurable bad-SWR threshold to prevent transmit is available.

Real time clock

A real-time clock can be displayed at the bottom right of the LCD. The time can be set by connecting a GPS receiver such as the QRP Labs QLG2 temporarily to the QMX. When power is disconnected from the QMX, the time is lost and will start at 00:00 at next power-up.

Built-in high performance 48ksps 24-bit USB soundcard

No more audio hum ground loops, or lossy noisy connections; a simple USB cable connection to the PC is all that is required for perfect lossless noise-free, hum-free audio transfer back and forth between QMX and the PC.

CAT control - PC Control commands

The same USB connection also implements a Virtual COM serial port for CAT control commands. This implements a subset of the Kenwood TS-480 command set, with one or two minor additions and exceptions.

It is intended to allow easy operation of the QMX in conjunction with logging software, which typically queries the transceiver to determine operating frequency and other operating parameters. The CAT control interface also supports some basic control features for remote control of QMX if required, and is used by software such as WXJT-X when in digital mode, to control the operating frequency and manage transmit/receive switching.

Rich terminal interface

The Virtual COM serial port connection can be used with a Terminal emulator such as PuTTY, to access a range of configuration, alignment and debug tools within QMX, all delivered over the

serial terminal interface. There are additional serial ports which may be enabled at a later time (firmware enhancement). The complete configuration menu is from the terminal too. Alignment tools include an RF sweep tool which uses the QMX' own internal signal generator injected into the RF port, to sweep across the band pass filters so you can check whether the performance is optimal and make adjustments if desired.

GPS Interface

The QMX kit has a GPS interface, which is used for calibration, setting the real time clock, and for frequency and time discipline and locator setting during WSPR operation. The GPS interface (1pps and 9600 baud serial data) shares the same pins as the paddle dit and dah signals (necessary due to limited processor I/O). The style of this interface is the same as the earlier QCX-series CW transceiver kits.

The GPS should only be connected during calibration functions or when the beacon is enabled. Connection at other times puts the radio into practice mode (no RF emitted) to protect the PA. You may temporarily connect the GPS while in ordinary operation mode, for the purposes of setting the real time clock.

QRP Labs Firmware Update

A special feature of QRP Labs kits based on STM32-series microcontrollers is the QRP Labs Firmware Update procedure (QFU). In firmware update mode, the radio appears to a USB-connected PC as a USB Flash drive. Updating the firmware is a simple matter of downloading the new firmware file, unzipping it, and copying it into QMX. Firmware updates will always be free. They will deliver performance and functionality enhancements and bug fixes.

ASSEMBLY

Assembly of the transceiver is covered in a separate document.

Note: QMX PCB Rev 2 should be used with firmware 1_00_011 and above.

This document describes operation of QMX, and applies to the firmware version specified. This manual will get you started with QMX, either as a standalone CW transceiver or with your WSJT-X or other digi modes software in minutes.

PLEASE READ THE BASIC ASSEMBLY AND USE INSTRUCTIONS IN THIS MANUAL VERY CAREFULLY BEFORE APPLYING POWER TO THE BOARD!

2. Connectors

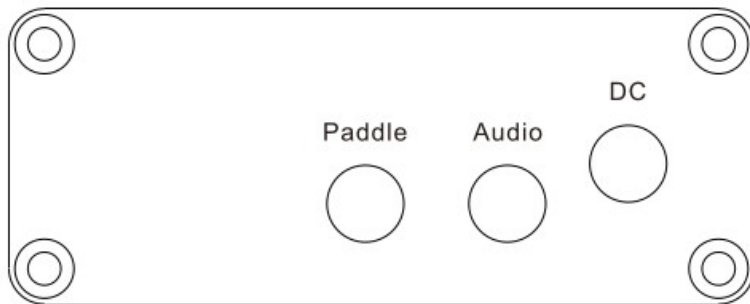

This is the QMX left panel.

Paddle connector

The paddle connector is a 3.5mm stereo jack socket and actually has THREE purposes:

1) Paddle for CW operation

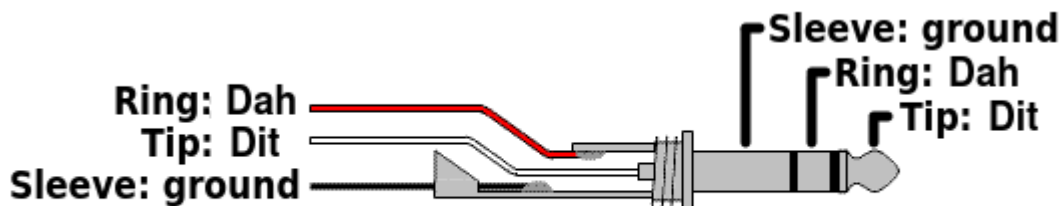

Paddle connections

Don't worry if your paddle has a reversed pinout, or if you connect the dit and dah to a 3.5mm jack plug incorrectly: there is a configuration item in the configuration menu (CW Keyer menu) allowing you to swap the dit and dah in the firmware.

2) GPS interface

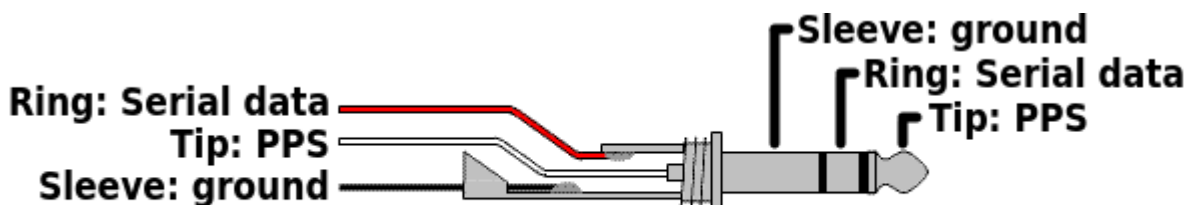

Paddle connector, used for GPS

Here the 1pps signal from the GPS must be connected to the 3.5mm jack "tip" connection, and the serial data (9600 baud) to the "ring" connection. In QMX these signals are 3.3V logic level; however they are connected to 5V-tolerant I/O pins on the microcontroller so 5V logic level will also work fine. If you are using a GPS module directly, and it has the common 2.8V output logic, this will also work fine.

Note that the QMX cannot supply +5V to the GPS module power supply, and in this regard the GPS interface differs from that of the QRP Labs QCX-series transceivers. So you need to arrange a separate 5V power supply for the QLG2 GPS (for example).

3). Microphone interface

In SSB mode, an electret microphone and PTT switch may be connected to the Paddle port.

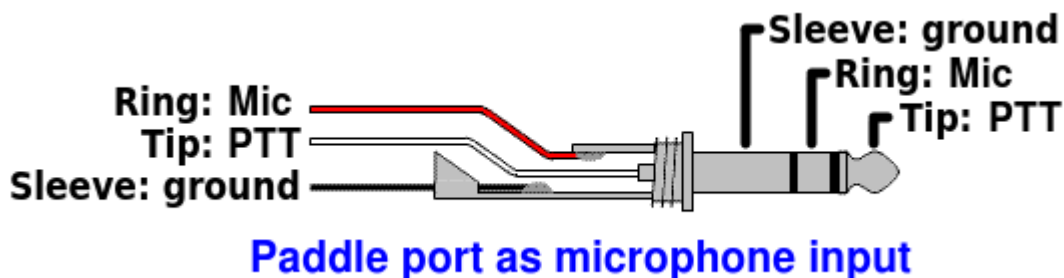

An internal +2.2K pullup to +3.3V is provided to power electret microphones.

Audio connector

The audio output connector is a standard 3.5mm stereo jack socket for connecting 32-ohm earphones or similar. It is not suitable for driving a loudspeaker directly. QMX internally controls the Left and Right channels separately which makes future interesting functionality possible.

DC connector

The DC connector is a 2.1mm barrel jack connector, the same as used on other QRP Labs transceiver kits such as QCX+, QCX-mini and QDX.

The center pin is positive, the barrel is ground.

The supply voltage range for QMX is 6.0 to 12.0V. Maximum power output depends on the supply voltage.

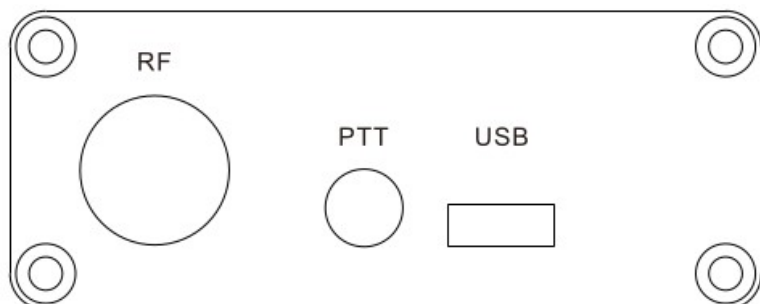

This is the QMX right panel.

RF connector

The RF connector is a 50-ohm BNC connector securely bolted to the enclosure. QMX should be used with reasonably well-matched 50-ohm loads. Note that the SWR bridge inside QMX means that there is a DC connection to ground; if you measure using a DVM continuity or ohm-meter between the center pin and ground, you will measure zero ohms. This also means that no additional bleeder resistors are required across a connected resistor, to bleed away static charge buildup.

PTT connector

The PTT connector is a 3.5mm stereo jack socket.

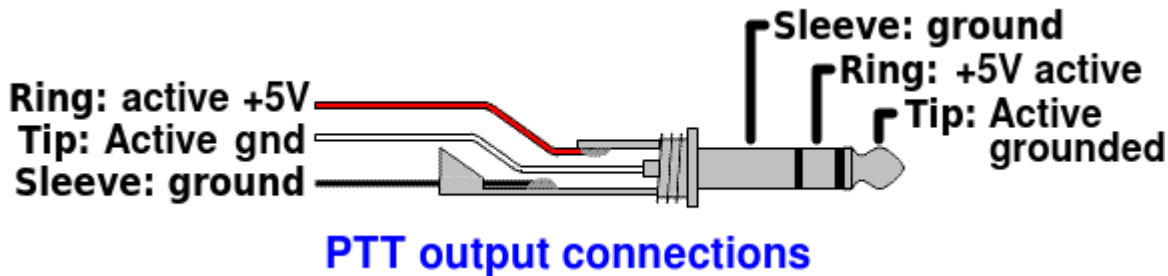

There are separate active grounded and active +5V outputs. The conventional way to control external amplifiers is with a grounded PTT. However the QRP Labs 50W PA kit requires a +5V active (Transmit) PTT control signal. So this PTT output connector is capable of providing both styles of PTT connection.

The two outputs can be configured individually per band, in the Band Configuration menu. Additionally they may be configured to also be active during receive – which may be used to control some external switching for example.

Note that the two outputs have 220-ohm resistors in series, to protect internal QMX circuits in the case of short-circuits.

USB connector

The USB connector is a USB-C type connector. When connected to a host PC, QMX appears as both a USB sound card (24-bit 110dB 48ksps) and a Virtual COM Serial port used for CAT control and accessing the terminal applications. It therefore effectively emulates a USB hub, with two devices connected (USB sound card, and Serial).

Additionally the USB connection is used during bootloader mode, when the QMX appears for firmware update purposes as a USB Flash drive (see later section on firmware update).

3. Display elements

The kit uses a 2 row, 16 character LCD module, with black text on a yellow/green background. There is a backlight which can be switched off if desired, to save a few mA of current consumption. The display has a large, easy to read font, and is perfectly readable in bright sunlight with no backlight.

The main display layout during ordinary operation (which will be called “main operating mode”) is shown in the following photograph. The display during beacon or message transmission modes, menu editing, alignment etc. differs. The main display elements are as follows:

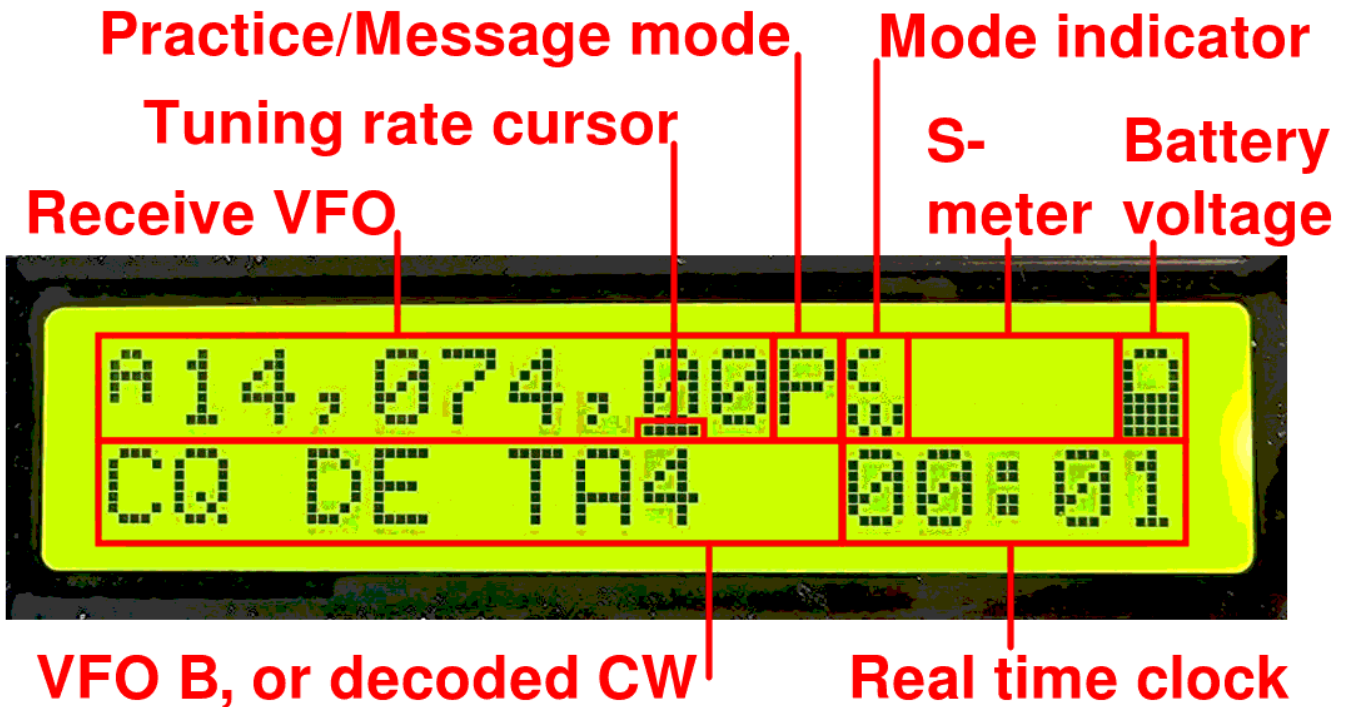

- The receive VFO frequency is always displayed, to 10Hz resolution, at the top left. This may be VFO A or VFO B. In CW mode the nominally 700Hz CW offset is automatically applied. Ordinarily in CW mode, the displayed frequency is also used for transmission.
- Tuning rate cursor: the underline appears under the digit which is currently tuned by the rotary encoder. In this example, the tuning rate is 100Hz per click, because the cursor is under the 100Hz digit.
- Practice mode: when in CW practice mode (actual transmitting disabled), a ‘P’ is displayed to the right of the frequency on the top row. If the practice mode was caused automatically as a self-protection, by plugging in the GPS, a ‘G’ is displayed. During saved message transmissions, this character is set to ‘M’ and in ordinary operation, it is blank.
- Mode indicator: this single character indicates the current operating mode of the transceiver; in the example in this photograph it is “CW”.
- S-meter: these 3 characters are configurable and display the S-meter/SWR/Power meter.
- Battery voltage: a battery icon appears to indicate the battery voltage in 7 user-definable steps: from full to empty and 5 steps in between. It may also be shown or hidden.
- Transmit VFO: in SPLIT mode, the transmit VFO is displayed on the bottom row of the display.
- RIT (Receiver Incremental Tuning): when not in SPLIT mode, and when the RIT is non-zero, the RIT value is displayed in the bottom left (where the photo shows the VFO B frequency). When RIT is non-zero, and when not in SPLIT mode, the reception frequency is the transmit VFO frequency (which may be VFO A or B) plus the RIT (which may be a negative offset).

- Decoded CW: The remaining space on the bottom row is used for displaying the decoded CW text. When RIT is zero, and you are not operating SPLIT or displaying the realtime clock, the whole 16 characters of the bottom row are used for the CW decoder display. When adjusting RIT or keyer speed, only the right section of the screen is used for decoded CW. The CW decoder may be disabled in the Decoder configuration menu.
- Real time clock: This can be enabled or disabled, and if enabled, is shown at the bottom right in HH:MM format; it can be set manually or via GPS serial data stream parsing (UT).

4. Operator Controls

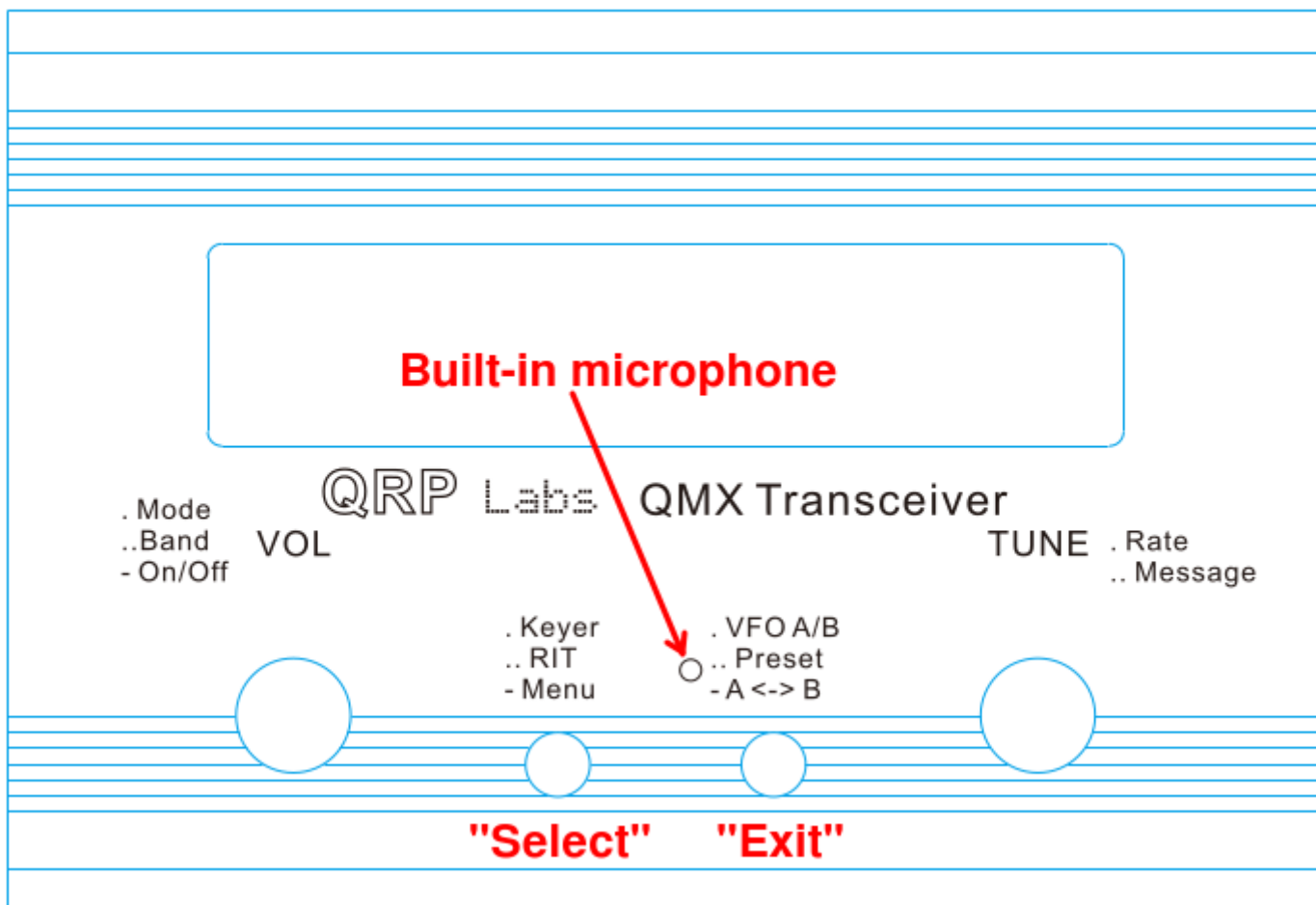

This diagram shows the operating controls of the QMX. There are two rotary encoders at left and right, and two push-buttons in the center. The main function of the left rotary encoder is Volume adjustment, and that of the right rotary encoder is Tuning. However, all of the controls have multiple functions, depending on the operating mode, menu editing, etc. The rotary encoders both have a button on their shaft activated by pressing the knobs, and these buttons also have multiple functions.

Most importantly: Press the left knob (VOL) with a single firm long press, to turn on or off the radio!

The two central buttons are used during menu editing primarily for "Select" and "Exit" functions and may be referred to in this manual, as the "select" and "exit" buttons. Select edits a menu item or steps down into a sub-menu; Exit saves an edited menu item or backs up to the parent menu.

It is well worth remembering while you are familiarizing yourself with the operation of the radio, that if you get into any unexpected function or menu – you can nearly always press the “Exit” button to cancel and get back to the main operation mode.

Each of the buttons may be pressed once, pressed twice (a double-click) or pressed for a long-hold. This facilitates three different functions for each button.

The laser-etched captions on the QMX front panel act as a reminder of the main functions of the various buttons and controls.

4.1 Tune rate

The right-hand rotary encoder tunes the active VFO. The rate of tuning is indicated by the underline cursor. In the example below, the underline cursor is under 100Hz digits. This means the tuning rate is 100Hz. If the cursor was under the comma , this would mean a tune rate of 500 Hz.



The available VFO tuning rates are 1kHz, 500Hz, 100Hz or 10Hz.

A press of the “Rotary” button (in the rotary encoder shaft) causes the tuning rate to change, in the cycle 1kHz -> 500Hz -> 100Hz -> 10Hz -> 1kHz etc.

You can also press-and-hold the rotary encoder shaft button, then turn the rotary encoder to move the cursor to the left or right; this allows selection of steps up to 1MHz; turn the rotary encoder within 0.3 seconds of the button press.

4.2 Keyer speed

During operation of the radio, the keyer speed can be easily adjusted. Click the “Select” button once (also indicated by the text “. Keyer” on the enclosure, and the speed will be displayed on the screen:



Now you can adjust the speed using the rotary encoder. Press any button to return to the main operating mode. You may operate the radio while the Speed setting is shown. You can also press the rotary encoder shaft button to select sending a stored message, while the Speed adjustment setting is active.

Setting speed to 0 enables “Straight” Key mode regardless of the keyer mode setting; this is useful for quickly being able to key down for antenna tuning purposes. It is much easier than going into the Keyer menu, selecting straight key mode, doing the tune up, then going back into the menu to change to lambic again. The normal configured keyer mode is automatically restored when you increase the speed above zero.

4.3 RIT

RIT (Receiver Incremental Tuning) allows the receive frequency to be adjusted while the transmit frequency (the displayed VFO frequency) remains the same. It is useful if the other station is off-tune, or drifting; other uses include working DX stations who may be listening on a different frequency some kHz away from their transmit frequency.

This radio transceiver allows RIT values from -9,999Hz to +9,999Hz.

RIT can be easily adjusted during ordinary operation by double-clicking the “Select” button (indicated on the enclosure as “.. RIT”:



Now use the rotary encoder to tune the RIT. As you do so, you will hear the RIT immediately applied to the VFO.

The tune rate of the RIT control is again indicated by the underlined digit (here 100Hz). In order to change the tune rate, press and hold the “Rotary” button (in the rotary encoder shaft) and turn the rotary encoder at the same time. You will see the cursor move to the left or right 1 digit at a time. Again, the cursor under the comma indicates 500Hz tuning steps.

To cancel RIT tuning (reset the RIT to zero), press the “Exit” button; this returns to main operating mode and sets the RIT to zero.

To return to the main operating mode, press the “Select” button. Now the RIT is displayed under the VFO, for example:



Remember that cancelling RIT mode is easy, just double-click the “Select” button to show the RIT editing, then press the “Exit” button to cancel it (which means, set it to zero).

Transmitting is possible while the RIT display is active. You can also press the rotary encoder shaft button to select sending a stored message, while the Speed adjustment setting is active.

4.4 VFO mode

A single press on the “Exit” button changes the active VFO mode. There are two independent VFOs named A and B. There are three VFO modes for using these VFOs:

- VFO A is active as transmit and receive VFO; if non-zero, RIT is applied during receive
- VFO B is active as transmit and receive VFO; if non-zero, RIT is applied during receive
- Split: VFO A is used for receive, VFO B is used for transmit; RIT is ignored completely

Split mode is often used by DX stations, they transmit and receive on separate frequencies.

4.5 VFO A/B operations

Frequency swap: the contents (frequency) of VFO A and B can be swapped by a single long key-press to the “Exit” button. This can be useful when setting up the VFO frequencies.

Copy VFO A to B: To copy VFO A to B, press the “Exit” button with a long key-press then a single short press. It is similar to tapping a CW ‘N’ slowly on the “Exit” button.

Copy VFO B to A: To copy VFO A to B, press the “Exit” button with a long key-press then a quick double-press. It is similar to tapping a CW ‘D’ on the “Exit” button.

4.6 Frequency Presets

There are 16 frequency presets which may be used for storing your favourite frequencies, or for just temporary use, or however you wish!

The presets are labelled 1 to 16, and can be individually edited in the Preset menu (see later). Often it is more convenient to just save them from the current VFO frequency.

To show the list of preset frequencies in normal operation mode, double click the “Exit” button. The display now shows something like this:



A14,027,50
S 1 14,060,00 L

The top row of the display shows the currently active VFO frequency as usual.

The bottom row shows a “1” in the 4th character, this is the number of the preset displayed. The next number (here 14,060,00) is the frequency stored in Preset 1.

Use the rotary encoder to scroll through the list of presets until you find the one you want. Once you have selected the desired preset, press one of the buttons to Save, Cancel or Load the preset, as follows:

- SAVE the current VFO to the selected preset, by pressing the “Select” button
- CANCEL the preset operation (back to main operating mode), by pressing right rotary encoder button
- LOAD the selected preset frequency into the current VFO, by pressing the “Exit” button

The “S” in the first character and “L” in the 16th character at the far right, are intended as a reminder of which of the center two buttons to press to Save and to Load.

4.7 Automated message transmission mode

My favourite use of the automated message transmission mode is to send a CQ call repeatedly. If a station answers, you can tap the key to cancel the message sending mode, then transmit.

There are 12 message memories. Each one is 50 characters long.

In order to send a pre-saved message, press the TUNE knob with a single long press. The first of the saved messages is shown on the screen, for example if a CQ call is stored in Message 1, you may have something like this:

```
A14,012,00  
1. CQ CQ CQ DE G
```

The bottom row shows the message number at the far left (here it is message 1) followed by the first part of the stored message. If it is blank, that means of course that you have not stored any messages yet!

You can now use the TUNE knob to scroll back and forth between the 12 stored messages and find the one which you want to transmit.

The message can be transmitted multiple times according to the “Repeats” parameter in the Messages menu (see later description). The interval between the repeated transmissions is also defined in the Messages menu, in the “Interval” parameter.

Once you have selected the message that you want to transmit, press one of the three buttons as follows:

- REPEAT: Transmit the message repeatedly by pressing the “Select” button
- ONCE: Transmit the message only once by pressing the “TUNE” knob button
- CANCEL: Cancel the messages operation by pressing the “Exit” button

When REPEAT message transmission mode is activated, the number of repeats and the interval between repeats is as specified by the Repeats and Interval parameters in the Messages menu.

The stored message transmission is sent at the currently defined keyer speed.

During the actual stored message transmission, you can immediately cancel the transmission at any time by pressing the “Exit” button or by keying the transmitter with the Morse key or paddle if you are using one.

While the RIT or Speed adjustment modes are active, you may still operate the radio (key the transmitter) and may also press the rotary encoder center shaft button to initiate stored message sending.

5. Menu System

There is an extensive nested menu system with all configuration or operating parameters for the transceiver stored in non-volatile memory (EEPROM). These are editable to control every aspect of the radio’s behaviour. The menus are organised into groups as follows:

- Presets
- Messages
- CW Keyer
- CW Decoder
- Digi interface
- Beacon
- Display/Controls
- Protection
- System config
- Hardware tests
- Factory reset
- Update firmware

To enter the menu system, give a single long press to the “Select” button. Use the TUNE knob to scroll back and forth between the sub menu groups listed. To enter one of them, press the “Select” button. To return to the main operating mode, press the “Exit” button.

The golden rule while in the menu system, is to press the “Select” button to go in to a deeper menu level or edit an item, and the “Exit” button to back up.

In order to edit a menu item, navigate to the menu item then press the “Select” button to start editing. When you have finished editing the item, press the “Exit” button to save it.

NOTE that changes to configuration parameters in most cases only take effect on the radio, when you leave the menu system and return to the main operating mode. During viewing or editing of menu items, the radio remains in receive mode on the currently selected VFO frequency.

5.1 Saving current operating parameters (VFO frequency etc)

When you power down QMX by pressing the VOL knob, the display will show “Shut down” briefly before powering down QMX. At this time, various important operating conditions of the transceiver are stored in non-volatile storage (EEPROM) that is retained while the power is off. Next time you switch on QMX, it will power up in the same state that you left it!

The list of items saved is:

- Mode (CW, Digi etc)
- VFO Mode (A, B, Split)
- VFO A frequency
- VFO B frequency
- Tune rate
- RIT
- RIT tune rate
- Volume level (audio gain)
- Keyer speed

5.2 Types of configuration menu item

There are five types of menu configuration item, and editing these is a little different depending on the type.

- 1) LIST: a fixed list of values applicable to that menu item, for example Keyer mode; certain boolean parameters are also equivalent to a list containing only two items (ON/OFF, DISABLE/ENABLE, NO/YES).
- 2) NUMBER: a numeric parameter such as a stored frequency preset
- 3) TEXT: a text configuration item such as a stored message

5.3 Editing a configuration menu parameter

To start editing a parameter, navigate to the desired parameter in the appropriate menu, and then press the “Select” button. When editing is active, you will see a cursor appear under the digit being edited.

For example, here is the message repeat interval setting, containing a small number (1 or 2 digits):



The underline cursor below the 4 indicates that editing is active; turning the TUNE knob will change the parameter value.

When you are finished editing, press the “Exit” button to conclude editing. This saves the parameter in the microcontroller’s EEPROM memory.

A flashing inverted cursor is also available, you can choose that in the “Cursor Style” parameter in the “Other” menu (see later section).

The procedure for editing list, string and number parameters is described below; the above simple example is a short number that is simply adjusted using the TUNE knob; for longer numbers such as frequency, the procedure is different (see following sections).

5.4 Editing a LIST parameter

Editing a list parameter is very simple, it is just a matter of turning the rotary encoder. The display scrolls through the list items. For example, this is the “Keyer mode” parameter in the “CW Keyer” menu:



Note that the editing indicator cursor appears under the leftmost character. Turn the TUNE knob to scroll through the list of possible values.

When you are happy with your selection, press either “Select” or “Exit”, to save the change.

5.5 Editing a BOOLEAN parameter

Editing a BOOLEAN parameter (such as YES/NO, ENABLED/DISABLED, ON/OFF) is exactly the same as editing a LIST parameter, except that now the list of items is always restricted to just the two values (representing True/False).

5.6 Editing a NUMBER parameter

When editing a number parameter, the cursor underline appears under the currently edited digit. The cursor starts at the far left (most significant digit). The TUNE knob adjusts the selected digit. The operation is very similar to tuning a VFO in ordinary operation.

This example shows editing the beacon frequency, in the beacon menu:



To alter the “tuning rate”, you can either

- a) Press the “Select” button to move the cursor to the next digit to the right OR
- b) Turning the VOL knob allows you to move the cursor left or right.

Editing of the number is concluded, and the number is stored to EEPROM, when either:

- a) You press the “Exit” button OR
- b) You press the “Select” button so many times that the cursor falls off the right hand side

Yet another way to input numbers, which is a REALLY convenient way, is to use the Morse key and CW decoder! During editing of numeric parameters, the CW decoder is activated but only decodes number characters 0-9. The CW decoder expects well-timed CW, with correct spacing between words and characters. The CW decoder expects you to key in the numbers at near to the configured Keyer speed. If you start keying in straight mode at a much different speed, the CW decoder will adapt to your keying but this may take several characters to “sense” your keying speed, so some characters can be missed. This is not a problem in Iambic keyer (paddle) modes.

When you have keyed in the whole number, the number is automatically saved to EEPROM, which leaves editing mode. Once you are used to editing numeric parameters by keying in CW, it becomes the easiest and fastest way to edit menu parameters.

5.7 Editing a TEXT parameter

An example of a text parameter you may wish to edit is the stored messages. For example, stored message 2 is edited in the Messages menu:



By far the easiest way to edit TEXT parameters is simply to use the CW decoder! As before, it expects well-timed CW, with correct spacing between words and characters when using straight key, and the CW decoder expects you to key in the characters at near to the configured Keyer speed. If you start keying with a straight key at a much different speed, the CW decoder will adapt to your keying but this may take several characters to “sense” your keying speed, so some characters can be missed. The problem does not occur with Iambic (paddle) keying modes.

Editing of the parameter is concluded either when you press the “Exit” button, or when no more characters are available for editing; for example, if you filled up the chosen Message memory.

It is also possible to edit a text parameter entirely with the buttons and rotary encoder, though this is usually a slower way to edit text parameters. Owners of the QRP Labs Ultimate3S (or earlier) QRSS/WSPR transmitter kits will already be familiar with this style of editing text.

The text parameter supports all of the characters which the Message keyer can encode, which is the same as the CW decoder can decode. Specifically, A to Z, 0 to 9, Space, then punctuation characters / = ? . , Note = is the break character, CW -...- (dah dit dit dit dah).

The following characters/symbols have special functions.

 **Insert:** Use this symbol to insert a character in the text. Find this character using the rotary encoder, then press the “Select” button to activate it. All the characters to the right of the cursor position are shifted right one position, including the character which was originally in the current position.

 **Backspace (delete):** If you select this character as the current character using the rotary encoder, then when you press the “Select” button, the current character is deleted and the cursor moves back left one position.

 **Delete all:** If selected as the current character, pressing the “Select” button has the effect of deleting the entire message, starting again at the left of the screen. There is no “undo”, so use with caution!

 **Enter Right (finished):** The behaviour of this symbol is the same as Enter, except that it preserves all the text, including the text to the right of the cursor. It simply saves the whole line.

 **Enter (finished):** If selected as the current character using the rotary encoder, pressing the “Select” button is used to finish editing the setting. The setting is saved, and you leave editing mode. Note that the text that is saved is only the text to the left of the Enter symbol. If you select this symbol and press the “Select” button when you are not at the furthest right position of the message, then everything right of your position is deleted.

You can also move the cursor backwards and forwards within the text being edited, by turning the VOL knob. This moves the cursor position within the text parameter.

5.8 Frequency presets menu

There are 16 frequency presets, labelled 1 to 16. This example shows Preset 5:



```
Preset 5
14,020,000
```

All of the Preset menu items are NUMBER types. Refer to the “Editing a NUMBER parameter” section above for instructions on how to edit a NUMBER parameter.

It is also convenient to load the current VFO into the preset memories as described in the section above titled “Frequency Presets”.

5.9 Messages menu

There are 14 configuration items in the Messages menu. The first 12 are the stored messages, each of which is up to 50 characters long. These are followed by the Interval and Repeats parameters.

The stored message presets are 50 characters long, and edited as per the “text” editing procedure described previously.

```
Message 1
```

Turn the TUNE knob to select the Message from 1 to 12 which you wish to edit, then press the “Select” button. Now you can edit the message text in one of two ways:

- 1) Choose each character individually from the list, using the TUNE knob to select the desired character; when you have chosen the correct character, press the “Select” button to move to the next character, or you can use the VOL knob to move the cursor left or right. This process is described in more detail in the preceding section on editing text parameters.
- 2) Key in the desired text on the straight Morse key on the board, or using your external paddle. The CW decoder must be enabled for menu editing (see “Enable edit” parameter).

PROSIGNS: Morse prosigns are typically pairs of concatenated characters which are sounded without a gap. The most common examples are AR, KN and SK (also known as VA). You can include any such prosigns in your saved messages. To specify a prosign, use the _ character. When the _ character is included in a saved message, it indicates that the following two characters are to be sent without a gap between them. You would typically use AR, KN and SK but there is nothing to stop you concatenating any pair of characters, to form other prosigns less commonly used.

```
Interval  
14
```

The Interval is a NUMBER parameter that specifies the interval in seconds, between repeated transmission of a stored message (if repeats are configured: see next parameter).

```
Repeats  
3
```

The Repeats parameter specifies how many times the message transmission will be repeated, in the repeat transmission mode. The Repeat parameter is a number from 0 to 99; in the case it is set to zero, the Message transmission continues indefinitely.

5.10 Keyer menu

The Keyer menu contains a number of configuration parameters relating to the CW keyer, which are described below.

```
Keyer mode
Iambic A
```

The mode of the CW keyer function in the firmware. Possible modes are:

- Straight
- IAMBIC A
- IAMBIC B
- Ultimatic

If you wish to use a traditional up/down Morse key, these are called “straight” keys and you should select the “Straight” mode. If you wish to use a modern paddle then select the desired operating mode e.g. IAMBIC A.

```
Keyer swap
NO
```

This is a BOOLEAN parameter which lets you swap the “dit” and “dah” connections in software, if you find that your paddle is reversed.

```
Keyer Weight
500
```

Ordinarily Morse dit and dah durations have a 1:3 ratio. The space between symbols is equivalent to 1 dit, between characters 3 dit lengths, and between words 7 dit lengths. This is standard Morse timing. However, some people may wish to alter this, for various reasons.

The Keyer Weight parameter allows variation of the ratios. The value has three digits. The default value of 500 corresponds to 50.0%. This means the “duty cycle” of a stream of dits is exactly 50%. The key-down dit length is therefore the same as the key-up inter-symbol pause.

If the weight is increased from the default 50.0%, then the key-down “dit” is made longer. A “dah” is lengthened by the SAME amount. The corresponding inter-symbol (or character, or word) gap is shortened by the same amount. The additional time spent on the key-down is therefore taken from the key-up period. The keyer speed is unchanged by altering the weight parameter.

As an example: suppose you want to make your Morse sound “harder” by shortening the dits and dahs. You could set the parameter to 450, which means 45.0%.

The parameter range is 050 to 950 (5% to 95%) though you would not normally ever need to go anywhere near these unreasonable limits. In the event that you enter a value outside this range, the firmware automatically applies these limits to the actually used parameter.

```
Auto Space  
OFF
```

Auto-spacing means that the pause between CW characters is forced to be 3 dit lengths (more or less, if you have CW weighting configured, see above).

The majority of keyers do not implement auto-spacing. You use the paddle to send your dits and dahs making up the Morse character you wish to send. As soon as you next press the paddle, the next character is started. The keyer forces correct 1:3 ratio of dits and dahs and inter-symbol spacing, but it does not force you to wait for the correct duration of 3 dits between transmitted characters.

Some keyers do implement automatic character spacing, such as the old (1973) Accu-Keyer design by James WB4VVF see <https://inza.files.wordpress.com/2011/01/accu-keyer.pdf> .

This configuration therefore allows you to switch on automatic character spacing if you wish. In this case, if you press a paddle too SOON, before the 3 dit durations have elapsed after the last character completed, the keyer will wait until the correct time to start the next character.

In the even that you press the paddle too LATE, there is nothing the keyer can do to travel back in time and force it to 3 dit lengths for you. You might have intended an inter-word space, for example. So pressing the paddle too late cannot be corrected.

```
Semi QSK  
OFF
```

This setting defines the break-in (QSK) behaviour of the radio. Two settings are possible:

OFF: indicates Full QSK mode. After the delay time for RF envelope shaping, the Transmit/Receive switch is set to "Receive" shortly after key-up. In this way, you will hear the other station (or any QRM, QRN etc) transmitting in between the dits and dahs of your own transmissions. Many experienced operators like to be able to have a feel for what is happening on the band, in between their key-downs. In some ways you feel like you are listening to your own sidetone audio as just another signal on the band, and you can still hear other signals too.

ON: Semi-QSK mode is enabled. After key-up, there is a delay before the Transmit/Receive switch is set back to "Receive" mode. The receiver is therefore kept muted during your whole CW transmission, not listening to the band in between your transmitted symbols. Many operators prefer to avoid the distraction of hearing the band between their dits and dahs. In Semi-QSK mode the Transmit/Receive switch is set back to "Receive" only after a suitable delay (of 8 dit lengths), long enough to occur only at the end of the transmission.

```
Practice mode  
OFF
```

Normally you would leave Practice mode switched OFF. However if you want to practice sending CW, and see if the CW Decoder can decode you, then you can switch Practice mode to ON. In practice mode, the radio does everything it normally would, except that it never sends any RF power to the antenna!

During practice mode, a 'P' is shown in the display to the right of the frequency on the top row.

```
Sidetone frq  
700
```

This NUMBER parameter allows you to change the Sidetone frequency if you wish. Sidetone is the audio tone which is generated by the microcontroller on key-down and injected into the audio signal path. Sidetone is ONLY an operator convenience to let you hear your keyed signal, and has no impact at all on the transmitted RF amplitude or frequency.

```
Sidetone vol  
099
```

You can use this parameter to reduce the volume of the sidetone audio. Most people will find the default setting of 99 too loud. So experiment with lower values until you find a sidetone audio level which you find comfortable.

When you adjust the sidetone volume by turning the rotary encoder after selecting a digit, the QMX will play the sidetone at the new volume briefly so that you can hear how it sounds and easily adjust it to a comfortable volume.

The sidetone generation uses a software simulated sinewave so it sounds clear and undistorted.

```
Straight mode  
Both
```

Available settings are "tip", "ring" and "both". This controls the action of a key plugged into the key jack during Straight Key mode only. It is inherited from the QCX-series transceivers; if a 3.5mm mono plug was used with the QCX+, the longer ground barrel shorted the ring to ground causing continuous keying. This configuration menu is the solution to that problem. If you are using a mono

3.5mm plug with your straight key, then set this configuration to “Tip” so that the ring connection (available only on stereo plugs) is ignored.

```
GPS protection
ENABLE
```

If QMX detects a GPS receiver has been plugged into the paddle port, it will automatically set up a temporary “Practice mode” (if practice mode is not already enabled) so that the radio is not continuously keyed by the incoming GPS serial data and 1pps. A ‘G’ character appears in the display to the right of the frequency on the top row (where the ‘P’ would be shown in Practice mode).

You can disable this automatic protection feature by setting the GPS protection mode parameter to DISABLE.

5.11 CW Decoder menu

The Decoder menu contains a number of configuration parameters relating to the CW decoder, which are described below. Some of these parameters control some aspects of the decoder behaviour. Some constructors may find it interesting to experiment with these settings and see if you can improve the performance of the CW decoder in your specific circumstances. For example, some stations may experience more noise interference than others, depending on your location etc.

Note that the Decoder is able to decode the Morse prosign symbols AR, KN and SK/VA. When shown in the decoded text section of the display, they appear as two characters, for example AR. When using the keyer to enter text into message menus, the two characters are prefixed by the _ character to indicate to the QMX that when replaying the message, the following two characters should be strung together without any gap.

```
Noise blink.
10
```

This parameter defines the duration of the noise blanker in milliseconds. The microcontroller’s 24-bit stereo I Q ADC samples audio at 48ksps (thousand samples per second). Blocks of 32 samples are analysed by an implementation of the Goertzel algorithm (kind of a single bucket of a Fourier Transform), which results in a digital filter bandwidth of 250Hz. In other words, it results in a measurement of the amplitude 250 times per second, i.e. once every 4 milliseconds. The amplitude is analysed by logic which compares it to a threshold amplitude to decide if a tone has been detected or not. Impulse noise that generates shorter pulses than the noise blanker parameter, is ignored.

If the noise blanking period is too short, then noise impulses will not be blanked effectively. On the other hand, if the noise blanking period is too long, then it will impair the decoder's ability to decode high speed Morse. For example, 24wpm Morse has dits lasting 50 milliseconds.

```
Speed avg.  
07
```

The duration of dits and dahs is measured in order to define a threshold at which to define a tone burst as a dit or a dah, and whether to define no tone at all as an inter-symbol, inter-character or inter-word gap. The measurement of this timing is implemented via an exponential moving average, whose averaging duration is determined by this parameter (the weight of each new measured symbol in the accumulated average).

If the exponential moving average is too fast (the parameter value is too low) then noise etc will throw off the timing averages too easily. If the exponential moving average is too slow (the parameter value is too high), then too many characters of the other station's transmission will be missed, while we try to adjust to the speed of his sending. This can be particularly offensive in some contest or pileup situations where exchanges are very short.

```
Ampl. Avg.  
60
```

The decoder maintains an amplitude threshold, which it uses to decide whether a tone is detected or not. The level of this threshold must be varied automatically in order to cope with stations having a wide range of different signal strengths. Other perils may include QSB (signal fading) of the station you are listening to. The amplitude threshold is implemented via an exponential moving average. The weighting of each new sample (every 4ms) added to the accumulated exponential moving average value is the reciprocal of this parameter.

If the exponential moving average is too fast (the parameter value is too low) then noise etc will too easily throw off the amplitude threshold and it may take time to recover to its proper level. If the exponential moving average is too slow (the parameter value is too high), then it may take too long to adjust to the received station's amplitude, resulting in missed characters while the decoder slowly adjusts itself. It would also be too slow to automatically respond to QSB (signal fading).

```
Enable Rx  
YES
```

An experienced CW operator may well dislike the CW decoder scrolling across the display all the time. With this setting you can switch "Enable RX decode" to NO and the receiver decoding is disabled.

```
Enable Tx  
YES
```

With this setting you can switch “Enable TX decode” to NO and the transmit decoding is disabled. When this setting is YES, the CW decoder will decode your own keying and display it on the screen while you transmit. For an experienced CW operator that may be distracting too!

```
Enable edit  
YES
```

This parameter enables CW decoding while editing. When YES, anything you key during editing of NUMBER or TEXT type configuration parameters, edits the parameter. This is a really useful feature that makes it very easy to enter frequencies or stored messages, for example.

```
SK or VA  
VA
```

This parameter only controls whether the SK/VA prosign character, when decoded, is shown as “SK” (this setting is OFF) or displayed as “VA” (this setting is ON).

The proper definition of this prosign character is somewhat disputed; some people believe passionately that it is SK, others that it is VA. For the sake of universal harmony this parameter therefore lets you choose your preference.

5.12 Digi interface

This menu contains settings relevant to the PC/QMX interface during Digital mode operations.

```
VOX  
OFF
```

If you want to use VOX (Voice Operated Transmission) then set this parameter to ENABLE. Any incoming audio from the PC will then operate the Transmit/Receive switch and be transmitted. When the audio stops, QMX will switch back to Receive automatically. The problem with this is that any system sounds on your PC, if the PC is configured to deliver these to the QMX USB sound card, will operate the transmitter and be transmitted.

The default setting “DISABLE” requires a CAT command from the PC host application (WSJT-X for example) in order to enable the transmitter. This is discussed in this manual in the section on setting up WSJT-X for QMX

If you wish to use software that does not support CAT Transmit/Receive switching, this may be one reason why you would want to enable VOX.

If using VOX, you will also need to disable the CAT timeout feature (see below).

The Voice Operated Transmit (VOX) function is not normally used. Normally you will wish to connect WSJT-X (for example) via CAT to the QMX Virtual COM serial port.

```
Rise threshold
80
```

This is a percentage signal level of maximum, above which the transmitter will be keyed down (switched on). Its purpose is to ignore very low amplitude audio signals at the start of a raised cosine keying envelope, whose audio tone could be decoded inaccurately due to quantization error. This is discussed further in the Design section of this manual in the Audio Frequency Analysis section. The default value of 80% should be fine for all purposes. The value should not be set too close to 99%, since higher frequency audio where the number of samples per cycle is small, may not contain a value sufficient to trigger this threshold in every cycle.

```
Fall threshold
60
```

This is a percentage signal level of maximum, below which the transmitter will be keyed up (switched off). Its purpose is to ignore very low amplitude audio signals at the end of a raised cosine keying envelope, whose audio tone could be decoded inaccurately due to quantization error. This is discussed further in the Design section of this manual in the Audio Frequency Analysis section. The default value of 60% should be fine for all purposes. The value should not exceed (or be close to) the Rise threshold parameter, otherwise the transmitter will be repeatedly keyed on and off falsely.

```
Minimum cycles
01
```

This parameter specifies the minimum number of audio cycles to use, in the measurement of audio cycle period, for audio frequency calculation. This parameter is used in conjunction with the Minimum samples parameter: both conditions must be satisfied in order for an audio frequency measurement to be completed. This parameter is discussed further in the Design section of this manual in the Audio Frequency Analysis section. The default value of 1 should be fine for all purposes.

```
Minimum samples
480
```

This parameter specifies the minimum number of audio samples to use, in the measurement of audio cycle period, for audio frequency calculation. This parameter is used in conjunction with the QMX operating manual Minimum samples parameter: both conditions must be satisfied in order for an audio frequency measurement to be completed. This parameter is discussed further in the Design section of this manual in the Audio Frequency Analysis section. The default value of 480 should be fine for all purposes.

Bearing in mind that there are 48,000 audio samples per second, a value of 480 specifies a minimum 0.01 second audio measurement period. In other words, there will be 100 measurements of the audio frequency, per second, in this default configuration. This is sufficient to ensure that high audio frequencies are measured accurately. In the unlikely event that frequencies below 100Hz need to be measured, the “Minimum cycles” value (1) will ensure that a longer measurement period is used, to measure one cycle.

```
Discard samples
1
```

This parameter specifies the number of audio cycles (zero crossings) which are ignored, when audio is first detected. The reason for this parameter is that in conjunction with the “Rise threshold” parameter, it can be seen that the first audio cycle after the threshold is passed, is not a complete cycle. The following zero crossing therefore needs to be discarded because its period measurement will be too short. The default value of 1 should be fine for all purposes.

```
IQ mode
DISABLE
```

When IQ mode is enabled, the raw I and Q channels from the ADC are fed to the USB soundcard directly, without any demodulation. This is suitable for people wishing to experiment with using QMX as an SDR front end, with PC SDR software to demodulate I and Q channels.

IQ Mode is not suitable for use with WSJT-X and other Digi mode programs.

```
TX shift thrshld
0
```

Specifies the number of milliHz that the detected audio signal during transmit must change before the Si5351A is reconfigured to transmit the new value. It can normally be left at zero. For modes

like FT8 it doesn't make any difference. For modes such as FST4W with very slow transmit cycles and very narrow tone spacing, this parameter should be lower or zero if possible.

5.13 Beacon menu

The beacon function is an added bonus feature of this QRP Labs transceiver kit! We already have extensive experience for several years, developing the Ultimate-series QRSS/WSPR transmitter kits (current incarnation, the Ultimate3S). These have a huge array of functionality and modes including CW, QRSS, DFCW, FSKCW, Hellscreiber (full speed and slow FSK), WSPR, JT9, JT65, ISCAT, Opera and PI4. The vast majority of people use the Ultimate3S kit for WSPR operation. Since it costs nothing (no extra hardware, at least) to add this functionality to the QMX transceiver, why not! Let's do it!

The CW transceiver beacon function therefore contains a simplified WSPR implementation which can transmit standard WSPR messages. It also has a GPS interface for discipline of time, frequency and Maidenhead locator. The implementation of course does not have the full range of flexibility and functionality as the Ultimate3S kit.

WARNING: WSPR transmissions operate a continuous 100% key-down duty-cycle for almost 2 minutes. You should check carefully whether the BS170's get too hot during this period. WSPR is much more demanding on the PA transistors than CW or other Digimodes such as FT8 which have alternating Transmit and Receive cycles.

The beacon function can also operate a CW or FSKCW (slow narrowband) beacon.

Weak Signal Propagation Reporter

WSPR stands for Weak Signal Propagation Reporter. It is digital message format filled with clever forward error correction. The message consists of three parts: the operator's callsign, Maidenhead locator (4-character, e.g. IO90) and two digits specifying the power. At the receiving station, messages are decoded and uploaded to a central internet database. At any time you can go to WSPRnet <http://wsprnet.org> and click on the map, enter your callsign (and other filters if you wish), and see a map of where your signal is being heard.

You could also undertake more in-depth propagation studies by downloading the database of reception reports.

The WSPR message is encoded into a set of 162 symbols, each may be 0, 1, 2 or 3, using a compressed data format with forward error correction. The symbols are transmitted as tones, each tone separated by 12,000 / 8,192 Hz i.e. approximately 1.46Hz. The duration of each symbol is the reciprocal of the tone spacing, which is approximately 0.683 seconds. WSPR messages take about 110.6 seconds to transmit, and always start at even minutes past the hour.

Due to the very narrow 6Hz bandwidth of the transmission, and the clever forward error correction, WSPR signals can propagate globally even with a fraction of a watt.

In WSPR, timing is critical, so when using WSPR you must set the time configuration parameter as exactly as possible. Be sure to keep the editing cursor under the rightmost (1-minute) digit of the time parameter, watch your clock until the seconds turn over to 00, and then press the "Select" button. This will ensure the seconds are in sync with your real clock time. If careful attention is given to setting the frequency and the real time clock, then successful WSPR reports will be obtained. Of course these things are easier if you are using a GPS module: the Maidenhead locator will be calculated from the received latitude and longitude, and the time decoded nicely from the GPS serial data stream.

The microcontroller in this kit takes care of the WSPR message encoding algorithm, without any assistance from a PC host computer. It also calculates the tone spacing and symbol duration.

In between message transmissions, the display will show instead just a clock (see below), while we wait patiently for the next WSPR transmission to begin, according to the settings of the configuration parameters Frame and Start. This is useful for checking that the time on your kit is accurately set. The display also shows the minute at which the next frame will start transmitting. In the example below, the time is 14:55:31 UT and the next frame will start at 14:56:01.

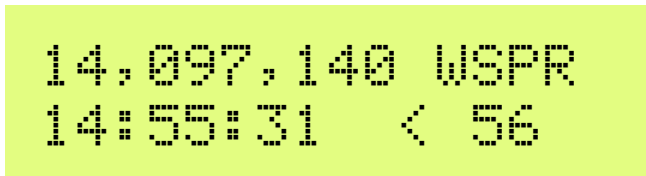

When a GPS unit is connected, the firmware automatically uses the 1 pulse-per-second signal to measure the transmit frequency and compensate for any inaccuracy due to calibration error or frequency drift due to temperature. The serial data stream from the GPS is used to set the real time clock (for syncing the WSPR transmission timing). The Maidenhead locator is computed from the latitude and longitude information parsed from the GPS serial data.

A WSPR transmission takes 1 minute and 52 seconds. The GPS time and location data is parsed from the GPS serial data stream at the END of every WSPR transmission. You should not configure your kit for continuous WSPR transmissions in every 2-minute WSPR slot (Frame parameter is 2), which is considered very antisocial to fellow WSPR operators.

A GPS receiver isn't essential for WSPR operation but it is highly recommended because it makes operation more accurate, easy and fun.

During the actual WSPR message transmission, the display shows something like this:

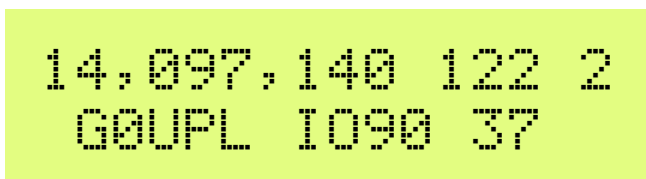

The elements of this display are explained as follows:

- 14,097,140 Transmission frequency (tone 0)
- 122 Current symbol is 122 (of 162 symbols making up a WSPR transmission)
- 2 Current tone being transmitted (one of 0, 1, 2 or 3)
- G0UPL Callsign encoded into the transmission
- IO90 5-character Maidenhead Locator square, encoded into the transmission
- 37 Power in dBm, encoded into the transmission

On a PC spectrum display such as the Argo software <http://www.weaksignals.com/> WSPR messages look something like the screenshot below when received locally (or usually worse, because you probably are over-driving your receiver when receiving your own signal!):



WSPR decoding takes place in the WSPR program by K1JT (see <http://physics.princeton.edu/pulsar/K1JT/wspr.html>). Below is a screenshot showing the WSPR 2.0 screen following reception of a few transmissions (output frequency = 1,500Hz, Frame = 02, Start = 00).

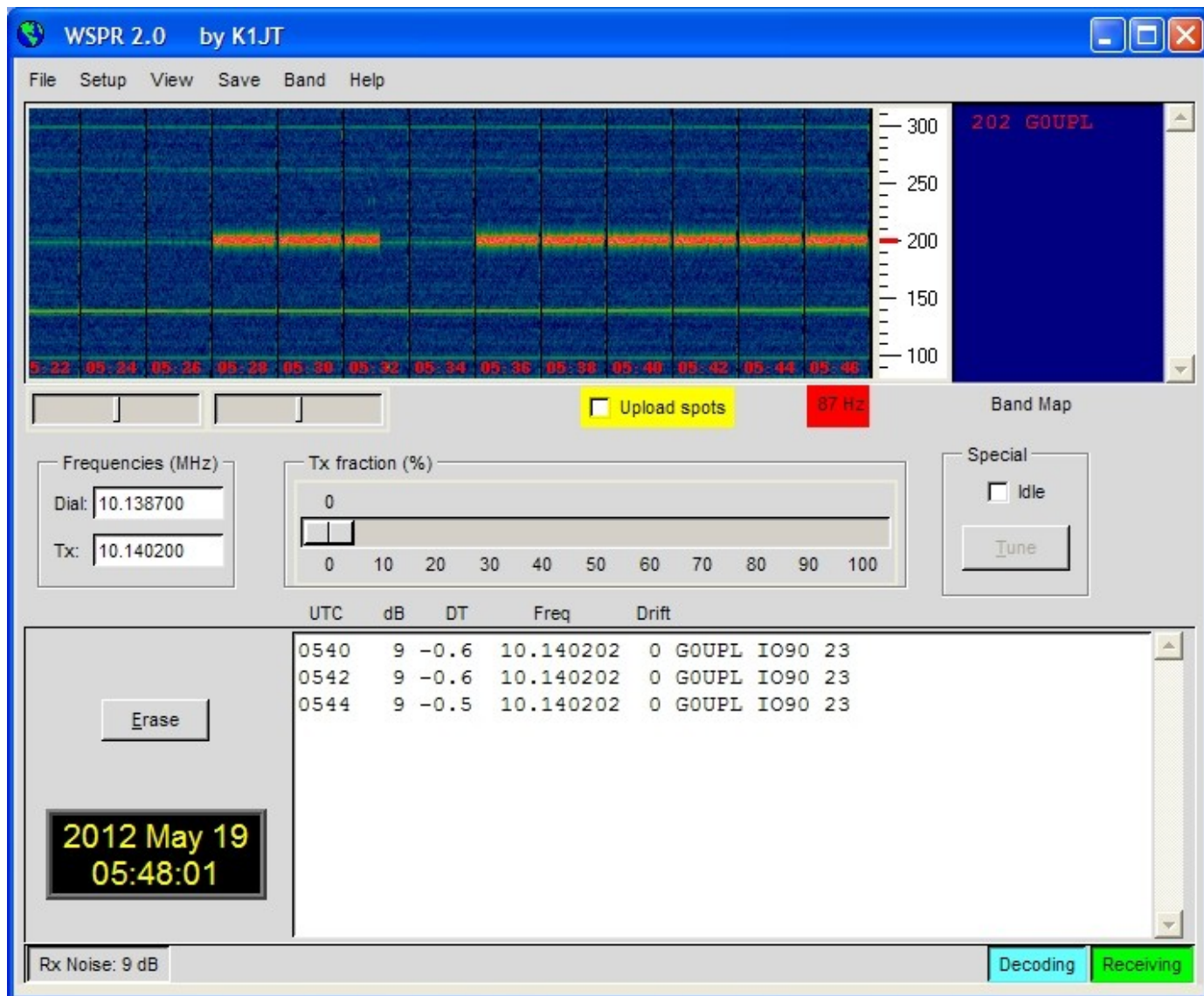

A number of other software packages are now also capable of decoding WSPR transmissions, the most popular of which is WSJT-X.

NOTE: the GPS interface is connected in parallel in the circuit, with the paddle. Therefore, you should NOT have the GPS connected, while operating the radio as an ordinary CW transceiver. If you do, the GPS serial data and 1pps will key the transmitter! Disconnect the GPS before using the radio as a CW transceiver.

The following sections describe the configuration parameters in the Beacon menu.



Mode
OFF

This parameter determines the transmission mode during beacon operation. There are four possible beacon modes:

OFF: The beacon mode is off, the transceiver is in ordinary manual operating mode

CW: the kit simply sends stored message 1 repeatedly, according to the configured Keyer speed, and with message start timing determined by the Frame and Start parameters (see next sections).

WSPR: the kit sends WSPR according to the configuration parameters in the following sections.

FSKCW: the kit sends stored message 1 repeatedly in slow FSK CW, where “key-down” is shifted up 4Hz and “key-up” is transmitted at the carrier frequency. The symbol duration is controlled by the keyer speed, interpreted as the number of seconds for a CW “dit”.

If beacon mode is enabled (not OFF), the radio starts operating in beacon mode on power-up.

While beacon mode is operational, it can be canceled immediately at any time by pressing the “exit” button. Remember that you should not have a GPS connected, when in ordinary CW transceiver mode – it would key the transmitter since the GPS and paddle share the same processor I/O signals – though if GPS protection is on (See Keyer menu), the radio will automatically enter a “Practice mode” where no RF is produced.

Beacon mode is entered upon leaving the configuration menu system, if the beacon is enabled by having this parameter set to a value other than OFF.



Frequency
14,097,140

This parameter determines the transmission frequency during beacon operation. In WSPR mode, this is the frequency of tone 0.

It should be noted that the WSPR sub-bands on the bands are only 200Hz wide. You also need to specify the correct frequency so that your transmission is inside the appropriate 200Hz sub-band. QMX uses a 25MHz TCXO reference which is normally within a few Hz, so accuracy of the transmission frequency is not normally an issue, even with no calibration.

Note that these are the actual transmission frequencies, there is no CW offset, no RIT, no other modifications. The specified frequency is also DIFFERENT from the “USB dial frequency” specified at WSPRnet <http://wsprnet.org> – the “USB dial frequency” is 1500Hz lower than the actual transmit frequency, so that the decoded audio is at 1500Hz.

Therefore, ensure that for WSPR transmissions, you choose a frequency in one of the WSPR sub-bands according to the following table (applicable only to the bands available in your QMX version):

80m:	3.570000 – 3.570200
60m:	5.288600 – 5.288800
40m:	7.040000 – 7.040200
30m:	10.140100 – 10.140300
20m:	14.097000 – 14.097200
17m:	18.106000 – 18.106200
15m:	21.096000 – 21.096200
12m:	24.926000 – 24.926200
10m:	28.126000 – 28.126200

```
Frame
10
```

This parameter defines the repetition rate of the WSPR transmission. In the example shown here, Frame 10, this means that the WSPR message will be transmitted once every 10 minutes.

Transmission in every 2 minute WSPR slot is considered anti-social. 10 minute repeat transmissions is usually considered normal.

```
Start
4
```

If everybody transmits with 10 minute repetition rate starting on the hour, then there will be bursts of activity every 10 minutes where everyone is transmitting at once, and the potential for interference from another station will be large. To avoid this, you can define the start timer. In this example a start time of 04 means that the first transmission will start at 4 minutes past the hour, and subsequent transmissions will commence at Frame minutes after that – in this case, 14, 24, 34 etc minutes past the hour.

```
WSPR call
G0UPL
```

The WSPR callsign is the first parameter which is encoded into the WSPR message. Your callsign must obey certain restrictions imposed by the WSPR protocol. These restrictions helps ensure that the WSPR encoding process can compress callsigns efficiently, along with the Maidenhead Locator square and Power level, into only 50 binary bits of information in total.

The callsign can only be 4 to 6 characters long. The callsign must consist of the following:

- 1) One character which can be A-Z or 0-9 or a SPACE
- 2) One character which can be A-Z or 0-9
- 3) One character which must be a number 0-9
- 4) Three characters which can be A-Z or a SPACE

For callsigns such as mine, consisting of 5 characters, I must enter a space character as the first character in order to satisfy these callsign rules. Others with two character prefixes like VK6JY would need a space character at the end "VK6JY ".

If the callsign you enter does not obey the necessary rules, then an error message is displayed on exiting the configuration menu system:

```
Beacon error!  
Callsign
```

In this case, go back to the WSPR Call parameter and try to understand how to correct it in order to make your callsign satisfy the requirements.

Note that if entering the callsign text using the key, you cannot enter a space with the key! So, you will need to enter the initial space character (if required) using the buttons and rotary encoder as discussed in the earlier section on editing TEXT parameters.

```
WSPR locator  
IO90
```

The Locator is the second parameter which is encoded into the WSPR message. It is the 4-character Maidenhead square. The text you enter here, must be a valid Maidenhead square, otherwise an error message will be generated on exiting the configuration menu system.

If you have connected a GPS receiver, the GPS receiver will update the Locator, computing it from the latitude and longitude information contained in the serial data string from the GPS receiver module.

```
WSPR Power  
37
```

The third and final parameter encoded into the WSPR message is the transmitter power, defined in dBm. Note that this parameter is manually edited here and is encoded into the WSPR message. It does NOT indicate a measured power which is actually transmitted. This is a common misconception. It only indicates what number the operator configured for the WSPR message encoding.

WSPR powers are constrained to certain values 0, 3, 7, 10, 13, 17, 20, 23, 27, 30, 33, 37, 40, 43, 47, 50, 53, 57 and 60dBm. If you specify a value not in this list, then an error message will be generated on exiting the configuration menu system.

In this example, the configured value is 37dBm which corresponds to 5 watts of RF transmitter output.

5.14 Display/controls menu

This menu contains items such as those concerning the elements that are enabled to be displayed on the screen, or the behaviour of buttons; there are also some other miscellaneous items in here which don't fit elsewhere.

```
CW-R  
OFF
```

This boolean parameter enables the CW-R mode. Ordinarily CW is received in Upper sideband with a 700Hz offset. There may be some occasions where operation on the other sideband is desired (lower sideband), for example to exclude an interfering nearby station when the CW filter performance is asymmetric. In these cases you can switch on CW-R by setting this menu item to ON, to select Lower sideband reception mode.

```
Dbl. click  
300
```

This is a NUMBER parameter which controls the decisions on what type of press has been made to a button. By default, it is set to 300 milliseconds (as shown here) but you may alter this if you wish.

It is the number of milliseconds after first pressing the button, at which certain decisions are made:

- If you have not pressed the button again after this interval, then it means you intended a single press.
- If you are STILL pressing the button all this time later, 300 milliseconds after the first press, then it means you executed a "single long press".
- If you pressed the button again before the 300 milliseconds elapsed, it is a "double click".

```
Pwr/SWR display  
ON
```

When set to ON, an RF Power measurement and SWR measurement is displayed. The power meter shows in the top half of the three meter characters to the right of the mode indicator, with a range from 0 to 6W, each pixel column is equivalent to 0.4W. The SWR meter is shown in the bottom half of the three meter characters, with a range from 1.0 to 4.0. Each column of pixels is equivalent to an SWR increment of 0.2.

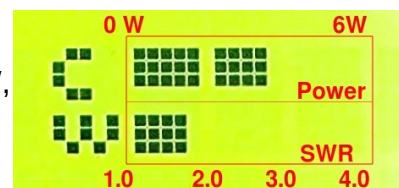

In this example (right), power (top half of display characters) is 3.6W and SWR is 1.8. Power and SWR measurements should not be assumed to be high accuracy but are a useful indication.

Battery icon Icon

This BOOLEAN parameter controls whether or not the battery icon is displayed on the screen at the top right corner. Measurement and display of battery voltage may be useful to those operators who intend to operate the radio from battery power, for example during portable operations. There are three possible values:

OFF No battery voltage is displayed;

Icon A battery voltage icon is displayed, configured according to the following parameters in the following section;

Voltage The top right corner character displays the actual voltage measurement, in a miniature pair of digits; the two bottom rows of the pixels of the character have a number of pixels lit which indicate the decimal point of the battery voltage (one pixel = 0.1V). In this example (right) the voltage is 12.2V.



Batt. full 12,000

This is the voltage, specified in millivolts, at which the battery is considered “full”.

Batt. step 1,000

This is the step, specified in millivolts, for each bar of the battery icon.

In this example, Batt. full is defined as 12V and the step is 1V. The battery icon has 7 possible states, ranging from empty to full and 5 intermediate states in between. The meaning of the displayed icon will be, in this example:

- Full: 11.00V to 12V (and indeed, above 12V also)
- 5 bars: 10.00V to 10.99V
- 4 bars: 9.00V to 9.99V
- 3 bars: 8.00V to 8.99V
- 2 bars: 7.00V to 7.99V
- 1 bar: 6.00V to 6.99V
- Empty: Below 6V

(NOTE: QMX should not be operated at above 12V or below 6V).

```
Cursor blink  
OFF
```

Two different cursor styles are possible. You can select your favourite, here. The two possible values are an underline cursor (the default), and a blinking cursor (the display alternates between the edited character, and a solid white block).

When set to ON, the cursor style is Blink. When OFF, the cursor style is Underline (default).

Note that this setting only affects the cursor that is shown during menu system editing. In normal operating mode, the underline cursor is always used for tuning rate indication, regardless of the Cursor style setting.

```
S-meter  
OFF
```

An S-meter is shown in the top right of the display, if this parameter is set to ON. The S-meter is not yet available as of firmware 1_00_009.

```
S-meter step  
100
```

This NUMBER parameter effectively defines the sensitivity of the S-meter in legacy QCX-series transceivers. When the S-meter is implemented in the QMX firmware, this parameter will become obsolete. It can be ignored for now.

```
Custom splash  
NO
```

You can use this configuration to display your own customized “Splash” screen on powering up the QMX. Ordinarily when you power up the QMX it will show this screen:

```
QMX      1_00_009  
QRP Labs, 2023
```

It shows the firmware version number (1.00_009 in this example). When you set the “Custom splsh” configuration parameter to YES, the contents of message memories 11 and 12 are displayed on the top and bottom rows respectively. You would then not normally use these

message memories for sending CW (though the system does not prevent it). If either memory 11 or 12 are blank, the default splash screen contents for the upper or lower row respectively will be shown. Therefore it is possible to customize one or the other or both rows, as you wish.



Clock
OFF

When set to ON, a real time clock is displayed in the bottom right part of the screen during operation. The time is NOT maintained when the QMX is powered down. You may set the clock by connecting a GPS such as the QRP Labs QLG2. Remember that the GPS and the paddle share the same microcontroller inputs (see schematic) and therefore the GPS signals key the transmitter. The QMX automatically detects the presence of GPS serial data and enables “Practice mode” to prevent keying (a G appears on the top line of the display) that due to the high duty cycle, could damage the Power Amplifier transistors if applied for a long duration. The QMX automatically parses the serial data when the GPS is connected (without needing to be in a GPS calibration menu in the Alignment menu, or operating in beacon mode). When the GPS is disconnected, the temporary Practice mode is automatically disabled, restoring normal operation of the transceiver. Therefore you may simply connect a GPS, wait for the real time clock to be updated, and then disconnect the GPS. This is a convenient way to set the time easily, if you have a shack GPS operational.



Delim
.

This parameter configures the delimiter character that appears between the MHz, kHz and Hz parts of frequency or numeric displays on the QMX screen. The default is a comma. Now the operator may select a dot if preferred; for example European convention is the use of a dot as the thousands separator.



Backlight
ON

This parameter controls whether the backlight is ON or OFF. This setting is saved in EEPROM and is applied at the next power-up automatically. The display is sunlight readable even with the backlight switched off. Switching off the backlight saves approximately 7mA of current consumption (at 12V supply).

5.15 Protection menu

```
SWR protection  
ENABLE
```

When SWR protection is enabled, the SWR is measured using the onboard SWR bridge at intervals of 1 millisecond. If the SWR exceeds the configured threshold then the transmitter is disabled by an automatically set protection mode in which the letter 'S' is shown in the character immediately to the right of the frequency display. Transmission is inhibited until this error condition is cleared. The error state is cleared by entering and leaving the configuration menu, or cycling power.

```
SWR threshold  
3
```

The SWR threshold at which transmission will be inhibited, if SWR protection is enabled.

```
Tune %  
50
```

During the SWR sweep and SWR measurement tool operation (see later in this manual) the supply voltage to the Power Amplifier can be reduced in order to protect the PA transistors (SWR protection is not enabled while running these tools).

Remember that there is a square law relationship between RF power output and PA voltage. The default Tune PA voltage of 50% means that the RF power output will be one quarter (25%) the full power value.

```
GPS protection  
ENABLE
```

When enabled, if a GPS is connected to the paddle port, keying of the transmitter is automatically prevented; this parameter is also available in the Keyer menu, please refer to the Keyer menu description of this parameter above.

```
Supply voltage
Prevent TX
```

This parameter controls protection against out-of-range supply voltages. It has three possible values:

OFF supply voltage range checks are disabled

Warn the battery voltage icon, if displayed, flashes to indicate the supply voltage range violation

Prevent TX while the battery voltage is out of range, the transmitter is disabled

```
Min voltage
7
```

The minimum supply voltage for the range check enabled by the Supply voltage protection.

```
Max voltage
13
```

The maximum supply voltage for the range check enabled by the Supply voltage protection.

5.16 System config

This menu contains several system configuration parameters which don't seem to belong in any other menu.

```
Band version
80-20m
```

Displays the band version of your QMX. You will have selected this at first power-up of your QMX. You can change it in this menu but the Band Configuration and other parameters will not be changed to reflect it; if you have chosen the incorrect band version at power-up and wish to reset the configuration appropriately for the version you built, the best way to do this is using the Factory Reset feature.

TCXO frequency
25,000,000

Default is 25000000 (25 MHz). This is the oscillation frequency of the QMX TCXO (Temperature Controlled Crystal Oscillator) and is used for calculating Si5351A parameters for setting the desired QMX operating frequency.

The supplied TCXO is a high precision component and will normally be found to be within (a one standard deviation error of) +/- 5 Hz of the specified 25 MHz value. It is not normally particularly necessary from an operating perspective, to have a more precise operating frequency than this. Remember that the error is also scaled to the operating frequency. So a 5 Hz error at 25 MHz will translate to a 2.8 Hz error at 14 MHz.

However the perfectionists among you may wish to calibrate your operating frequency precisely – and this menu entry is for you!

To configure the correct TCXO reference frequency, you will need to measure your operating frequency, deduce the error amount, and apply a correction to the TCXO frequency configuration parameter.

As an example, suppose your transceiver is set to a USB “Dial Frequency” of 14.0956 MHz and WSJT-X is set up to transmit WSPR at 1500 Hz audio offset. This should result in a transmission frequency of 14.097100 MHz. But let’s suppose that you measure it accurately, and you find that it is 3 Hz high, at 14.097103 MHz. Now what?

There’s an error of +3 Hz in your operating frequency. To work out the required correction to the TCXO reference frequency configuration, calculate 3 Hz multiplied by a ratio of 25 MHz / 14.0971 MHz, which results in 3 Hz x 1.77 = 5.3 Hz. Therefore you should increase the reference frequency by 5Hz. So edit the TCXO frequency to 25,000,005.

How about if you don’t have an accurate way of measuring your operating frequency? I have developed tools for QRP Labs website to help you to use the WSPRnet reporting network to determine your operating frequency quite accurately. To use these tools, simply use WSJT-X and QMX to operate as a 20m WSPR reporter (receiver) for several minutes, then look at this page:

<https://qrp-labs.com/images/wsprnet/rxerror.html>

Look for your callsign in the list, which shows the error in your reception reports (operating frequency error). Alternatively, you may operate as a WSPR transmitter using WSJT-X and QMX, and the following page will show your actual transmitting frequency:

<https://qrp-labs.com/images/wsprnet/txfreq.html>

Both of these QRP Labs pages are updated every two minutes. The analysis loads the last 2 minutes (approximately) of 20m WSPR reports from the WSPRnet website database. It crossreferences all the reports, analyzing the error of receiver stations by cross-referencing against reports of the same transmitters by other stations. In this way calibration errors of all receiving stations in the network are averaged out. The accuracy is generally within 1 or 2 Hz.

```
Japanese limits  
DISABLE
```

When this setting is enabled, QMX will refuse to go into transmit mode if the specified synthesis frequency is outside the Japanese band limits as specified in the JARL bandplans document https://www.jarl.org/English/6_Band_Plan/JapaneseAmateurBandplans20200421.pdf. This setting is useful for Japanese license regulations compliance.

```
CAT timeout  
ENABLE
```

When this setting is enabled, which it is by default, there is a timeout on Transmit; if the timeout elapses and QMX does not receive a CAT command requesting it to switch back to Receive, then it will automatically switch back to Receive. This feature needs to be disabled if using VOX.

```
CAT timeout (s)  
120
```

The duration of the CAT command timeout (see above), in seconds.

```
PTT as Serial 3  
NO
```

Enabling this parameter changes the behaviour of the 3.5mm PTT jack. This jack becomes an additional serial port. This requires a HARDWARE change to remove and bypass the transistors driving the PTT signals. The port is then a 3.3V logic (5V logic tolerant) serial port with configurable baud rate.

```
IQ Mode  
DISABLE
```

When IQ mode is enabled, the raw I and Q channels from the ADC are fed to the USB soundcard directly, without any demodulation. This is suitable for people wishing to experiment with using QMX as an SDR front end, with PC SDR software to demodulate I and Q channels.

IQ Mode is not suitable for use with WSJT-X and other Digi mode programs.

```
Sideband
USB
```

This setting determines the demodulation sideband. Normally Upper Sideband (USB) is used for all digital modes, and is the default setting. If you wish to use Lower Sideband (LSB) for some reason, you can change it here. Use the left and right arrow keys to change between LSB and USB.

```
Advanced config!
```

Selecting this (by pressing the left button) enters the Advanced configuration sub-menu. Ordinarily you should not need to change anything in this menu, and doing so may damage your QMX! It is highly recommended NOT to change anything in the Advanced configuration sub-menu unless you really understand the consequences of your actions.

```
CAUTION! Danger!
Proceed anyway?
```

To underline the un-recommended-ness of entering or changing anything here, when you select the Advanced configuration sub-menu you will receive a warning, and have to press the “Select” button again.

The following FOUR settings exist in the “Advanced config!” sub-menu.

```
DO NOT DISABLE!!
```

The first item is just an informational message, warning you again, to NOT disable any of the subsequent three options! You see – I’m really quite serious about warning you:

DO NOT MEDDLE HERE!

(unless you really understand what you are doing, and accept taking the risk).

Mod. High in RX ENABLE

This parameter controls whether the PA amplitude modulator is set to High during Receive. If set to “ENABLE” the PA voltage is high during Receive. This means the PA voltage is around +12V (assuming +12V supply) during Receive.

The BS170 transistors are all off (zero gate voltage) and therefore there is no current flow through the PA transistors. However the Drain-Source junction of the BS170 MOSFETs have a capacitance which is dependent on applied voltage and it is best to MINIMIZE this capacitance, and therefore the effect of the inactive PA on the receiver, during Receive. Furthermore the BS170 MOSFETs have an intrinsic “body diode” which will, at some level, act to clip the incoming Receive signal; by applying a +12V reverse bias to this body diode, we can ensure that this never happens.

Leaving this setting at “ENABLE” is recommended to maximize theoretical dynamic range and IP3 performance of your QMX receiver, though the actual improvement has not been determined experimentally by measurement. I am grateful to John Dzubrozek KJ4A for suggestion this feature as a result of his PA simulations and subsequent theoretical analysis.

If you select “DISABLE” for this feature it will not damage your QMX but it may not optimize Receiver performance.

Normal 5ms shape ENABLE

When enabled, the normal 5ms (or similar, depending on configuration) Blackmann Harris envelope shaping is applied on CW and Digi mode rise/fall times. When set to “DISABLE” the Blackmann Harris envelope shaping is sped up by a factor of 33.33 times, which has the effect of shortening the rise/fall time to approximately 0.15 milliseconds. This is used for testing the response of the PA envelope shaping and Transmit/Receive switch and corresponding BPF switch stability under fast rise/fall times, which are approximately equivalent to a full amplitude 3.2kHz sinewave component of an SSB waveform and are therefore harsher than the worst case conditions which will be expected during SSB transmissions. This feature is designed for experimental and development purposes. In practical use it should be left at ENABLE.

20/80m BPF TXswaf ENABLE

Enabling this feature is part of a protective measure against instability which destroyed BPF the multiplexer on Rev 2 PCBs. It is described in this forum post:

<https://groups.io/g/QRPLabs/message/113662> and you are recommended to read this if interested. **Disabling this feature, particularly on an 80-20m Rev 2 (and above) QMX PCB, is REALLY NOT RECOMMENDED.**

5.17 Hardware tests

The hardware tests menu provides access to several application tools designed to allow you to optimize and test your QMX hardware

GPS Viewer

```
GPS viewer
```

Currently in firmware 1_00_009 the GPS viewer is the only hardware test tool available on the LCD. Additional hardware test tools are available when you connect a terminal (see subsequent sections).

The GPS viewer tool provides three screens which display information about the GPS data being parsed, if a GPS is plugged into the paddle port. You can scroll between the three available screens using the TUNE knob.

```
06AUG23 16:28:31  
A 3D f13 t21 s36
```

The first screen is an overall status screen. If no GPS is connected, it will simply state "No data" and the subsequent two screens will contain the headings only, with no values.

When a GPS is connected, the screen shows the main data, as follows:

- Date: the UT date; in this example it is 6-August-2023.
- A heartbeat appears between the date and time fields, which blinks in time with the incoming 1pps signal, so allows you to verify its correct operation.
- Time: this is UT time in 24-hour format; in this example it is 16:28:31.
- Validity flag: A means the GPS has acquired enough satellite data to compute a fix; V means invalid (as yet, no fix).
- 3D: indicates the type of fix, 2D or 3D
- Number of satellites in fix (solution). f is for "fix". Here, 13 satellites are used in the fix computation.
- Number of satellites being tracked. t is for "tracked". Here, 21 satellites are being tracked.
- Average signal strength of tracked satellites. s is for "Signal". In this example, it is 36 dB.

```
LT 51 30.08321  
LN 0 08.96731
```

Latitude and longitude.

```
Grid 1091FE  
Alt 23.749
```

The grid subsquare and altitude.

SWR measurement

```
A 7,074,00 50%  
40m SWR: 1.04
```

The SWR measurement tool enables the transmitter at a reduced supply voltage determined by the operating percentage defined in the Tune % parameter of the Protection menu. This percentage is displayed for information on the top right of the screen.

The top left shows the operating frequency for the SWR measurement, which is the center frequency of the band.

The band name is displayed in the bottom left, and SWR measurement in the bottom right. The SWR measurement is updated ten times per second.

Controls:

- Use the right rotary encoder to change the band.
- Start the SWR measurement by pressing the left push button (Keyer/RIT/Menu). The SWR will continue to be displayed until the SWR measurement tool is closed, or the left push button is pressed again, or the rotary encoder is turned to change the band, or a 60 second timeout expires.
- Use the right push button to exit the SWR measurement tool.

5.18 Factory Reset

This menu item can be used to cause a factory reset. Factory reset returns you radio to the supplied default factory configuration. Everything is erased and set back to the default parameter values. In order to prevent accidentally triggering this drastic step, the factory reset is implemented as a two-step process.

```
Factory reset  
Sure? Click Tune
```

After pressing the Select button to activate the Factory reset, the screen will ask you if you're Sure? Press the TUNE knob to confirm.

Factory reset takes a few seconds while the entire EEPROM contents are written.

5.19 Update firmware

This menu item can be used to reboot QMX in the bootloader mode, activating the QRP Labs Firmware Update procedure (QFU). Again it is implemented as a two-step process.



```
Update firmware
Sure? Click Tune
```

After pressing the Select button to activate the firmware update, the screen will ask you if you're Sure? Press the TUNE knob to confirm.

QMX will reboot into bootloader mode, and appear on a USB-connected PC as a USB Flash drive. You can then copy in the new firmware file. This procedure is described in more detail in a following section.

6. Operating QMX on digital modes

Operation of the QMX transceiver on digital modes is really simple. A USB-C cable is required between the PC and the QMX. Naturally you need a power supply and the antenna connection too.

QMX must be set to Digital mode, to be able to use the PC and QMX combination for digital modes! Press the VOL knob to change the mode on QMX.

Drivers

The QMX audio device (USB soundcard) is standard on all PC types (Linux, Windows, Mac) and no additional drivers are required.

For the Virtual COM serial port, no additional drivers are required for operation with most Linux distributions, Apple Mac or MS Windows 10 or Windows 11.

For older versions of MS Windows, it may be necessary to install a driver for the serial port because this driver is not on your computer already by default. This driver is available from the ST Semiconductor website at <https://www.st.com/en/development-tools/stsw-stm32102.html> and is applicable to 98SE, 2000, XP, Vista®, 7, and 8.x Operating Systems. There is a description for installation on Windows 7/8 on the QRP Labs QLG2 page <http://grp-labs.com/qlg2> so if in doubt, please check this.

Linux special note

On Linux systems, a particular problem can occur. When the QMX Virtual COM (Serial) connection is detected, the PC thinks that a modem has been connected and starts trying to send it Hayes AT-commands dating back to 1981, implemented on Hayes' 300-baud modem. Yes! 40 years ago...

The Operating System attempting to send AT commands to your QMX will certainly mess everything up. Not least because when QMX receives a carriage return character, it will enter Terminal Applications mode; this will send all sorts of characters back to the PC (as QMX thinks it is now talking to a terminal emulator) and it will disable CAT command processing, so your PC digital modes software will not be able to talk to QMX. Disaster.

To fix this you need to issue the following commands to disable ModemManager:

```
sudo systemctl stop ModemManager
sudo systemctl disable ModemManager
sudo systemctl mask ModemManager
```

This will permanently stop ModemManager. If for some reason, you actually DO need ModemManager operational, for some other reason... well there IS a way to stop it just for QMX... but Google will be your elmer on this!

Additional information from Greg Majewski:

There is another Linux service, BRITTY, that does the same. BRITTY is a Braille service for access by sight impaired people. I have encountered the problem with the G90 and Ubuntu on a

laptop (Ubuntu full version), Raspberry Pi 3 with Raspberry OS and the Orange PI 800. Here are commands that remove BRITTY:

```
sudo systemctl stop brltty-udev.service
```

```
sudo systemctl mask brltty-udev.service
```

*note output: Created symlink /etc/systemd/system/brltty-udev.service
→ /dev/null.*

```
sudo systemctl stop brltty.service
```

```
sudo systemctl disable brltty.service
```

These commands are similar as used for Modem Manager service.

WSJT-X configuration

Next it is necessary to set up WSJT-X to communicate with QMX. We will use WSJT-X as the example, because it will be what most people are using. But other software will be identical (for example JS8Call) or similar. There are two parts to the set-up – firstly to choose the right USB Sound card, and secondly to set up the CAT communication so that WSJT-X can control the QMX via the serial comm port.

Open the WSJT-X settings window (from the File menu) and select the Audio tab. Select “QRP Labs QMX Transceiver” as the input and output sound card. The below screenshot shows how it looks on my system, which is Linux (Xubuntu 18.04). It will look different on Windows, Mac and perhaps other Linux distros but the basic idea will be the same... you should see something in the drop-down which says something about QMX, and that’s the sound card to select.

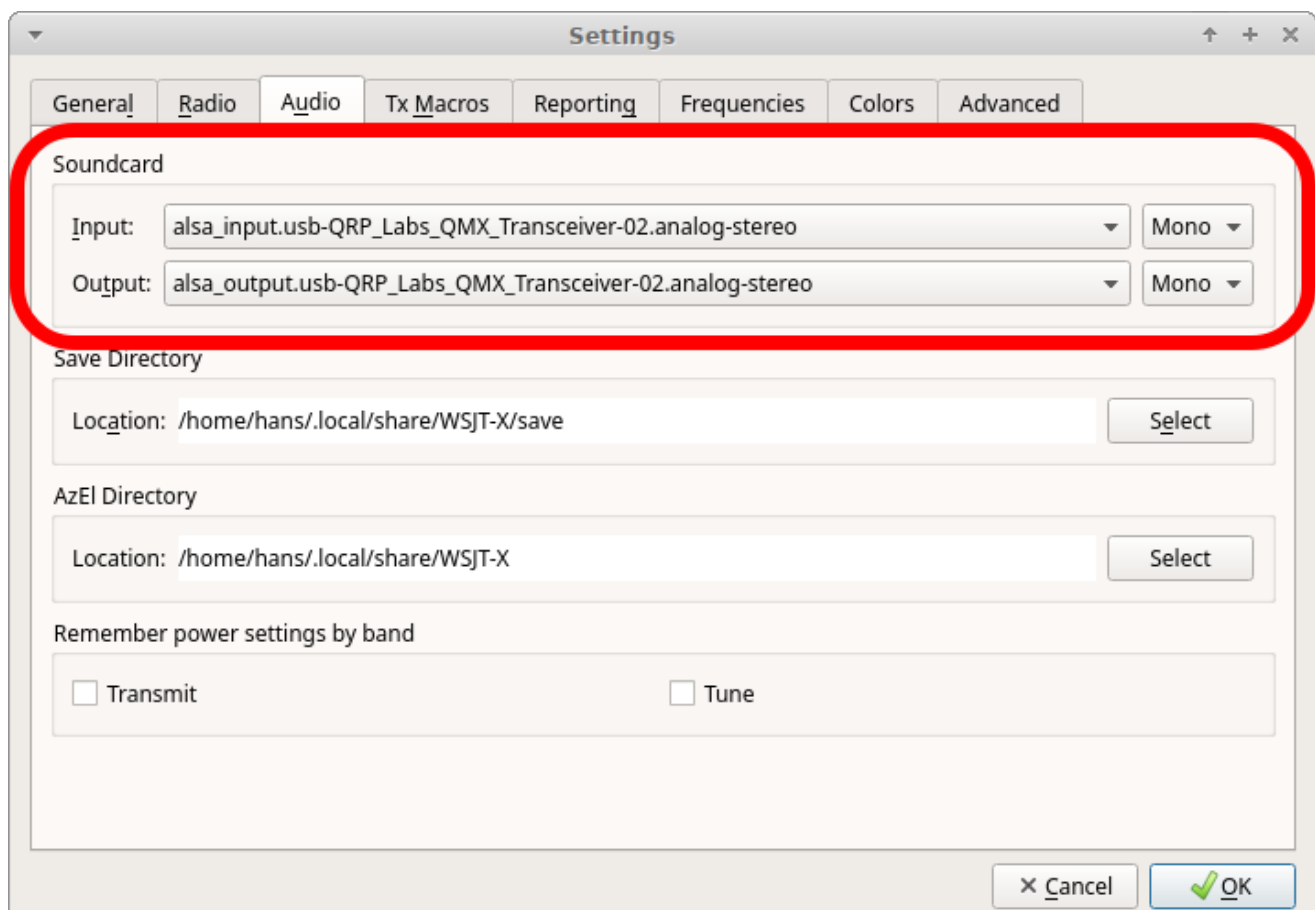

Next click the “Radio” tab in the settings window, which sets up the CAT control communication.

The following four settings need to be changed, and are illustrated in the diagram below:

- Rig will be set to None by default, click the drop down and choose “Kenwood TS-440” which should work well with QMX. On some other software, if you find that TS-440 is not present in the list or does not work properly, you could try “Kenwood TS-480”. More details about CAT and debugging any CAT problems are in another section of this manual, where the CAT test terminal screen is described.
- The Serial Port drop-down must be set to the correct port where QMX is connected.

On my Linux system it is either “/dev/ttyACM0 or /dev/ttyACM1. On Linux you can also access a serial port via its unique device name, which will be: “/dev/serial/by-id/usb-QRP_Labs_QMX_Transceiver-if00”. This doesn’t change depending on which other devices are connected.

On Windows systems it will be a COM port numbered COM1, COM2 etc.

Unfortunately unlike the USB Sound, the serial port name doesn’t contain the text “QMX”. If you are unsure which port to choose for QMX, the easy way to find this is as follows.

Unplug QMX. Restart WSJT-X. Look in Settings -> Radio and make a note of the list of serial devices. None of these are QMX (because you unplugged it). Now close WSJT-X, plug in QMX, start WSJT-X and again look in Settings -> Radio, and now you should see a newcomer in the list of available ports. The newcomer is QMX!

- Note that none of the Serial Port Parameters need to be changed, leave them all at their defaults. Even the baud rate 9600 is unimportant because it is irrelevant to the USB Virtual COM Port which is a virtual port over USB, not a real physical serial port.
- Change the Poll Interval to 10 seconds, the default will be rather chatty with QMX which probably is not a problem, but anyway I feel more comfortable with the less frequent polling. QMX has no capability to alter its operating frequency for example by itself, it can only do so at the command of WSJT-X over CAT; therefore the polling is actually redundant anyway.
- Change PTT Method from the default “VOX” to “CAT”. VOX means “voice operated exchange” or “voice activated transmission”; the radio will automatically switch to transmit, when incoming audio is detected. With PTT Method set to CAT, when WSJT-X wishes to start a transmission, it will send an actual CAT command to QMX informing it to start the transmission, before sending the audio. This CAT command causes QMX to switch from Receive mode to Transmit mode (and back again afterwards). “CAT” is preferable to “VOX” because if system sounds are accidentally routed to your “QMX” sound card as output, then with VOX that will enable the QMX transmitter and try to transmit the sound.
- Now click the “Test CAT” button and after a few seconds, it should turn Green to indicate successful communication with QMX.

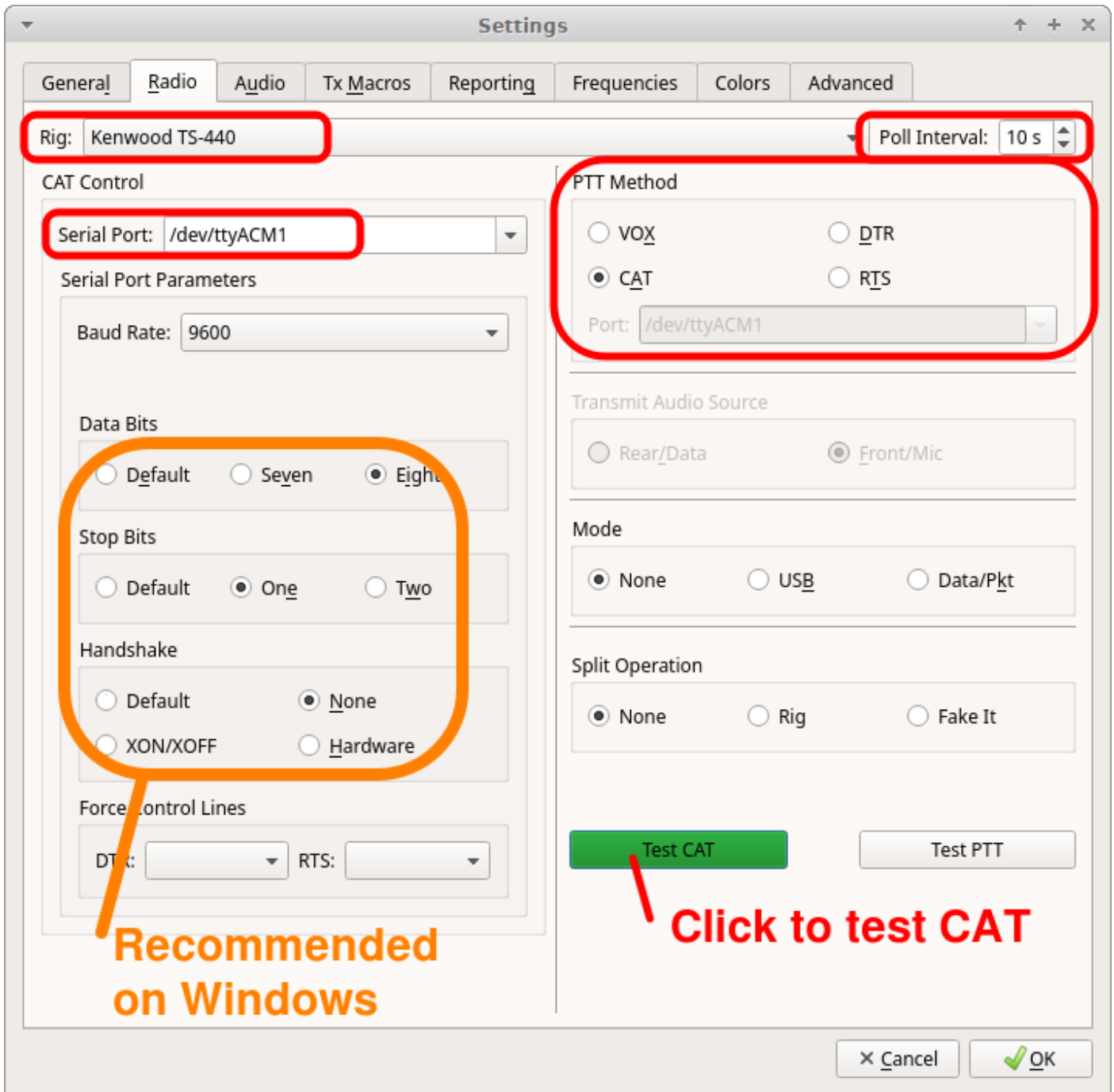

NOTE 1: If you are using other software than WSJT-X or JS8Call, then QMX CAT commands should still work with this software. If you encounter difficulties then it is possible that your software is trying to communicate with QMX using CAT commands that are not supported by QMX. In the section of this manual on the CAT Test utility (in the QMX Terminal applications), you will find a listing of the CAT commands supported by QMX. Another useful utility is the log file, which will let you record all CAT commands received and investigate any issues. If CAT commands are missing for your application, QRP Labs can add support for them easily.

NOTE 2: As mentioned above, CAT control of transmit/receive switching is recommended. If you INSIST on using VOX, QMX can support that. For example, you may be using a software application which does not support CAT control of transmit/receive switching and can only use VOX. In that case you should change the QMX transmit/receive switching mode from CAT to VOX in the QMX terminal Configuration utility or in the menu on the QMX itself, which is described elsewhere in this manual.

NOTE 3: The Data Bits, Stop Bits, Handshake should not need to be changed; however several users have reported that changing them to the settings shown in the orange box has resolved some issues with CAT reliability on Windows Operating Systems.

WSJT-X “Pwr” Slider

The only other point to note is that WSJT-X should be operated with the power slider at the maximum setting. This point is discussed further in the QMX design section which explains that best accuracy in determining the audio tone frequency being sent by the PC, is when the Pwr is at the maximum setting. There is no point to using any setting other than maximum, because QMX only ever transmits at full power (5W), there is no way for it to transmit at a lower power output under command of WSJT-X. If you wanted a lower power output, you would need to use a lower supply voltage. Furthermore, QMX cannot be “over-driven” by too high volume, in the way that a SSB transceiver could.

Therefore the “Maximum” setting for the Pwr slider is highly recommended, it is the optimum setting for QMX operation.

The screenshot displays the WSJT-X v2.1.0 interface. The top section shows 'Band Activity' with columns for UTC, dB, DT, Freq, and Message. The right section shows 'Rx Frequency' with columns for UTC, dB, DT, Freq, and Message. A large red callout with the text 'Set Pwr slider to maximum' points to the 'Pwr' slider in the bottom right corner of the interface. The slider is currently set to the maximum value. The bottom section of the interface includes a frequency display showing 14.074 000, a date and time display showing 2021 Sep 23 13:39:12, and various control buttons like 'Enable Tx', 'Halt Tx', 'Tune', and 'Menus'. The status bar at the bottom shows 'Tx: CQ TA4/G0UPL', 'FT8', 'Last Tx: <SQ9EZE> TA4/G0UPL 73', and 'WD:6m'.

Transmit status indication during QMX digital transmissions

The QRP Labs QDX transceiver front panel contains a 3mm red Status LED, which can inform the operator the status during digital transmissions and firmware update. QMX has no such LED. However, QMX has an indicator on the top left character of the LCD, under the 'A' symbol of VFO A.

Note that the transceiver must be put into DIGI mode before attempting digital transmissions from WSJT-X otherwise they're just ignored.

1. TX status is a single dot:



This means that QMX has been put into transmit mode via an appropriate CAT command from WSJT-X, however it is not receiving any audio, so there is no RF output. The usual reason for this is that QMX has not been selected correctly as the output device in the WSJT-X audio settings screen. Refer to the section above on the audio configuration. The single dot could also mean that there is no audio because somewhere in your PC sound settings you have MUTE enabled.

2. TX status is two dots:



This means that QMX has been put into transmit mode via an appropriate CAT command, and that it is receiving audio from the PC; however the audio level is too low, so there is no RF.

Remember that there is a "Rise Threshold" setting in the QMX Configuration terminal application, which defaults to 80% of maximum value. If the amplitude of the audio sinewave coming from the PC is less than 80%, key-down will never be triggered.

It is therefore highly recommended to set the audio output level of the PC to 100%. Unfortunately this simple recommendation can be the cause of great confusion. The exact places to set the volume varies also depending on the operating system (Windows, Linux, Mac). But in principle there are THREE places on the PC that all affect the output channel volume, and all three need to be set to 100%:

1. The output volume of the software application itself, for example the "Pwr" slider in the bottom right area of the WSJT-X screen; these should always be left at maximum.
2. The output device corresponding to QMX must be set at 100% also. In Linux Sound Manager (XUbuntu 18.04 example shown), the Output Devices tab for QMX should have its slider set to 100% as per the example below. Don't set it to more than 100%!

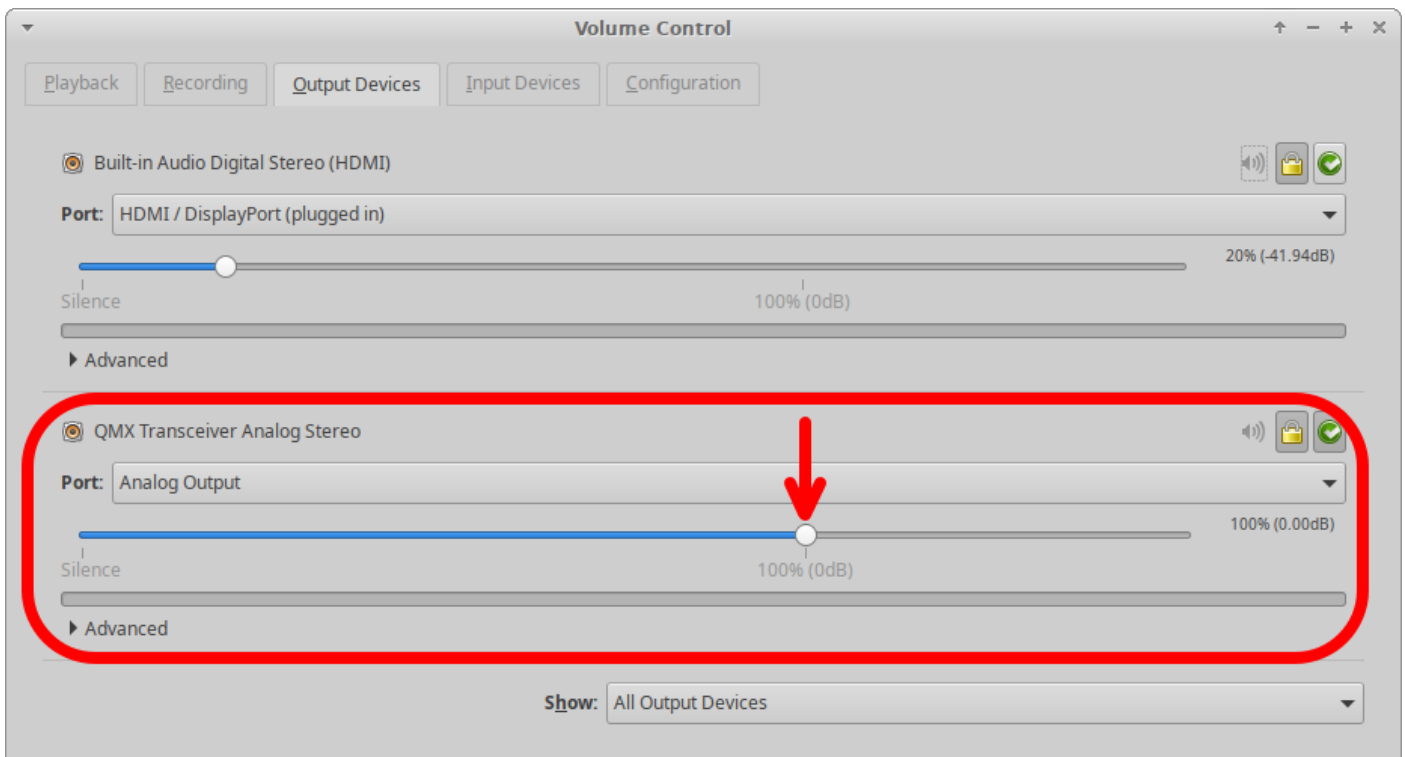

3. The “Master Volume” control of the PC should also be set to 100%. There is such a setting in both Windows and Linux (and most likely Mac too). In Linux, clicking the loudspeaker icon at the bottom right of the screen shows which audio device is being used for the default sound output; selecting QMX will show you the master volume level, and it needs to be set to 100% (not more, not less). There’s a similar thing on Windows OS.

3. TX status is a solid line:



Everything is fine! TX state, enough audio, and so you should have RF Power output! If you are STILL not getting power output then this indicates a hardware problem, either with QMX, or with the connections to your power meter.

QMX transmitter hardware problems are often the result of failure to properly remove the enamel from the enameled copper wire on the toroids and/or binocular core, resulting in no electrical connection.

Further troubleshooting is available on the QMX web page <http://qrp-labs.com/qmx>

Operate!

Once CAT is configured and working, and the QMX sound card is chosen, just operate WSJT-X as you would normally! You can choose the desired band 80m, 60m, 40m, 30m or 20m from the WSJT-X screen and WSJT-X will communicate with QMX via CAT, to cause QMX to switch in the correct filters.

This QMX manual is not the place to include tutorials on various digi mode operation or particular application software such as WSJT-X, such guides are readily available and written very much more thoroughly than I could hope to achieve!

7. Firmware Update procedure

On occasion QRP Labs may make available updated firmware for QMX, in order to deliver bug fixes or functionality enhancements.

QMX contains a new firmware update procedure for STM32-series microcontrollers, called QFU (QRP Labs **F**irmware **U**date) which provides the following features:

- **Easy** – anyone can do the firmware update
- **No additional hardware required:** only a standard USB A-B cable (or micro-USB cable if you have installed a micro-USB connector)
- **No additional software required:** just the standard file manager application that is already available on any PC
- **No drivers:** no special drivers need to be installed, the existing drivers on any modern PC operating system are used
- **Works on any PC Operating System:** and in the same way: Windows, Linux, Mac
- **Secure:** firmware files are published on the QRP Labs website and are encrypted using 256-bit AES encryption technology

Entering bootloader (firmware update) mode:

QMX provides three possible ways to enter firmware update mode:

- 1) Via a long press on the left of the two center buttons (“Select” button, labeled on the enclosure as Keyer/RIT/Menu) to enter the menu system, use the TUNE knob to move through the menu to select the “Update firmware” option (refer to earlier section on QMX menu). QMX will enter bootloader mode, the QFU (firmware update) mode.
- 2) Select the “Update firmware” menu option in the QMX Terminal (see subsequent section of this manual). QMX will then enter firmware update mode.
- 3) If you really get desperate – and this should NEVER be necessary – the third way is to add a jumper wire between two of the pads along the top edge of the main PCB near the top left corner under the LCD, as shown. When these two pads are connected, at power up the system will be forced to enter bootloader (firmware update) mode.

In the firmware update mode, the LCD backlight is OFF, nothing is displayed on the LCD, and none of the buttons or controls or connections are operational, other than the USB cable to show the device on the PC as a USB Flash Drive.

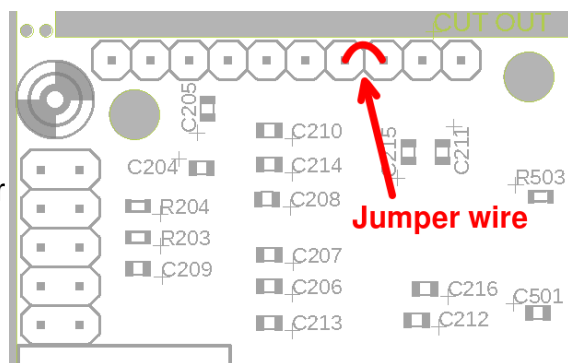

Exiting bootloader (firmware update) mode:

QMX provides two possible ways to exit firmware update mode:

- 1) Update the firmware! After updating the firmware, QMX will automatically reboot in normal operating mode.
- 2) Power down QMX, and re-apply the power again. QMX will reboot in normal operating mode.

USB Flash memory stick emulation:

In the firmware update mode, the QMX pretends to be a USB Flash memory stick, having a 4MByte capacity and implementing a FAT16 file system. This virtual “Flash stick” contains two files:

1. the firmware program file of the QMX microcontroller. You may read the file from QMX, or write a new one, just by dragging files in your file manager application.
2. EEPROM contents: the QMX configuration and log file (if enabled). Again, you can read the file from QMX or write a new one to QMX, simply by dragging files in your file manager application.

Note that QMX is not a real USB Flash drive! It only emulates just barely enough USB Flash drive functionality to be able to achieve the desired purpose of copying firmware and EEPROM contents in and out. This sometimes confuses people. There is no capability to delete files so don't bother to try; similarly, you can't copy in any other types of files. If you try to delete or copy in other types of files, it might LOOK like it's successful; this is just because your PC caches what it thinks is correct directory information.

On entering the Firmware update procedure, a pop-up window should appear on your PC. On my system (Linux XUbuntu 18.04) it looks like this:

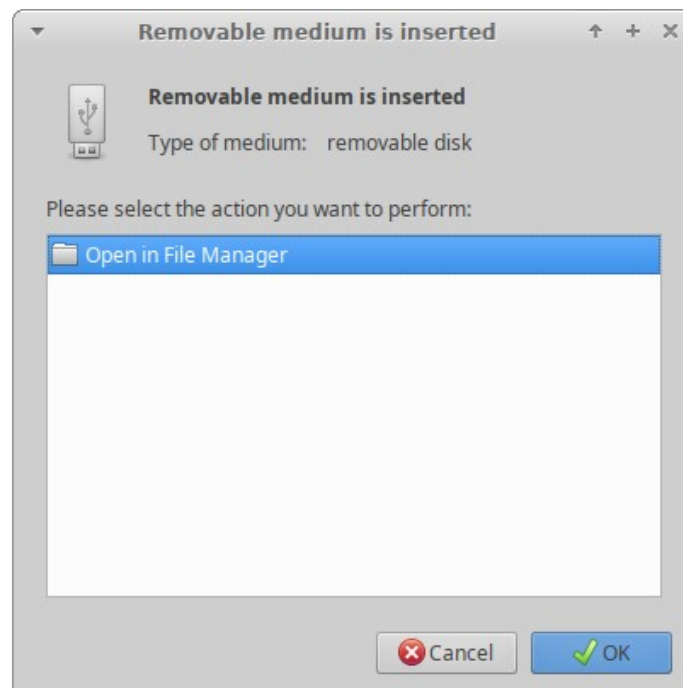

Click the OK button.

The File Manager window will then open, and on my system looks like this:

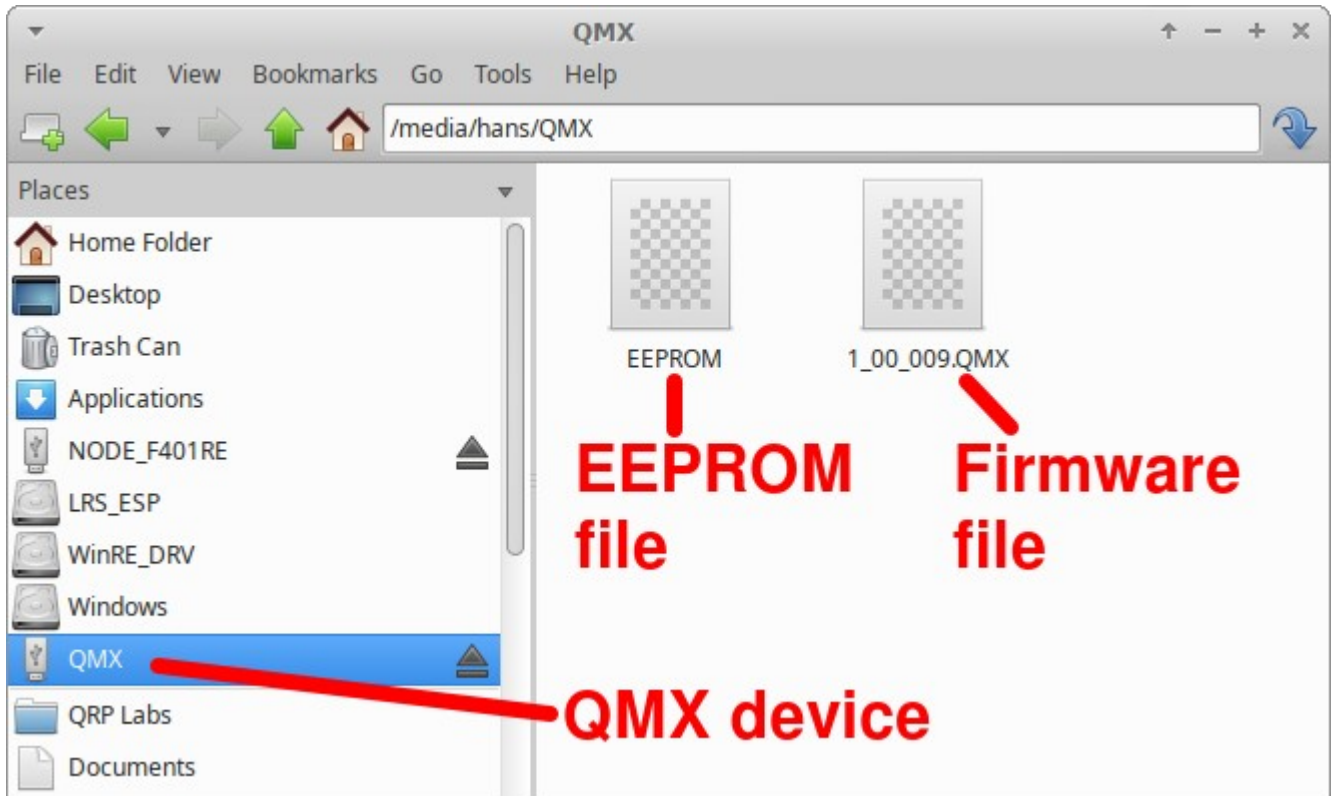

QMX appears as a removable USB Flash device named “QMX”, and the folder two files. The firmware file in this example is named shows a single file which is the firmware version file, 1_00_009.QMX in this example. The EEPROM file is always named EEPROM. You can read and write EEPROM files in order to make and restore backup copies of your configuration etc.

The firmware file name must not be longer than 8 characters, and cannot contain punctuation or spaces; the file extension must be no more than 3 characters. This is because the file system emulation is FAT16 and these are the specifications of the FAT16 format.

You may check the properties of the file and will note that it is a 529K file. QMX firmware images are always a 529K file. The creation date and modification date etc. have not been set, because it was important to minimize the size and complexity of the QFU bootloader, in order to maximize the space available to the application firmware.

You may copy the existing firmware file to another directory of your computer. Crucially, to do the firmware update, all you need to do is copy the new firmware file to this QMX “Flash disk”.

Download the new firmware file from the QRP Labs website, unzip it, and simply drag it into the folder where the existing firmware file version is shown. Or copy and paste it, however you wish.

The file on the QRP Labs website is a ZIPPED file, please be sure to unzip it to get the .QMX file before copying it to QMX.

As soon as you copy the new file to the QMX QFU “flash drive”, the QMX QFU bootloader erases the current program from its memory and installs the new one.

The QMX firmware is 256-bit AES encrypted and this means:

- The encrypted QMX firmware file will only work on a QRP Labs QMX board, it cannot be installed on any other board, even one containing the same processor.
- No other firmware file will work on the QRP Labs QMX board except an official QRP Labs encrypted QMX firmware file.

The procedure will vary slightly for different Operating systems but in all cases is just a simple matter of copying the new firmware file to the emulated QMX QFU USB Flash drive.

The above firmware update procedure works on ANY modern OS because the QFU bootloader emulates a USB Flash memory stick with the USB Mass Storage Device (MSD) class, for which drivers are already present.

The QFU bootloader implements a USB device stack (Mass Storage Device class), emulated FAT16 file system, Flash erase/write, and 256-AES encryption.

8. Terminal Applications

QMX provides a suite of powerful terminal applications which may be accessed via a Terminal emulator running on your PC. These applications provide configuration screens, operating utilities and various self-test tools. It is very educational and interesting to experiment with these tools.

Most QMX users need never feel they MUST use the terminal applications, it is not necessary for ordinary operation of QMX with WSJT-X etc, or as a CW transceiver. However, it is an easier way to add stored messages or frequency presets. The terminal applications are for the interested user, or if you need to set up a particular configuration.

The terminal applications display everything as ASCII text in a 80 x 24 character window. It's not as polished as a dedicated graphical user interface software application for QMX would be. However, it has the advantage of requiring no special software or drivers, and all the variations that would have to be supported for different PC Operating Systems such as Mac, Windows and Linux, software installation procedures etc. Instead, all the applications are hosted and coded in the QMX itself. The terminal emulator is only used to display the results. This keeps things simple and low maintenance. After all, the terminal applications are useful bonus features rather than core QMX functionality.

8.1 PC terminal emulator

I use Linux (XUbuntu 18.04) and I'm using the PuTTY terminal emulator. There are numerous other terminal applications which will work fine. You may have your own favourite. They are all capable of correct operation with QMX in its terminal mode.

I start PuTTY using command line "sudo putty" then connect to QMX on /dev/ttyACM1 or /dev/serial/by-id/usb-QRP_Labs_QMX_Transceiver-if00. Again as before (refer to the Operating Instructions for connecting to QMX using CAT on WSJT-X) it is necessary to know which serial port is being used by QMX. There is also a guide to identifying the serial port at <http://qrp-labs.com/qlg2> (scroll down the page); or you could use WSJT-X.

Make sure WSJT-X is NOT running, when you connect to the QMX serial port using the terminal emulator. Only one PC application at a time can connect to Virtual COM Serial ports.

Set the size of the terminal window to 80 columns and 24 rows.

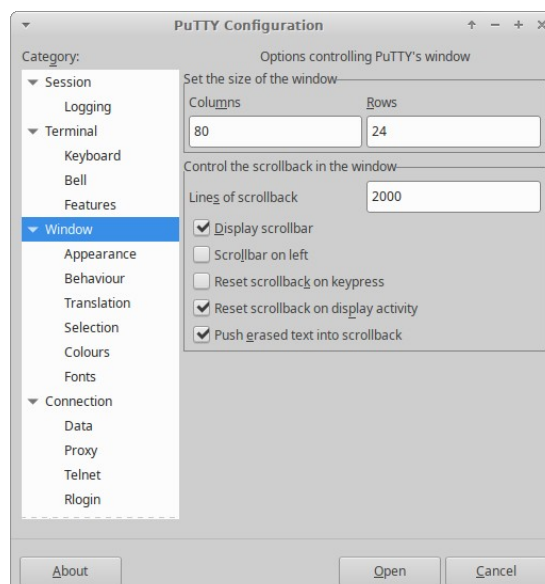
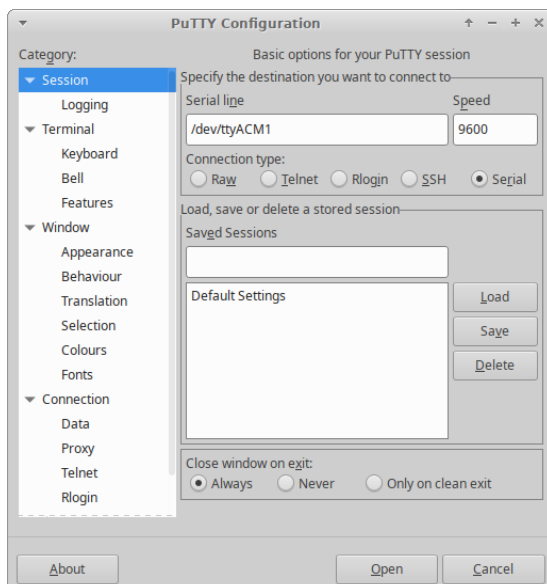

8.2 Entering terminal applications mode

Normally the QMX serial port is connected internally to the QMX's CAT command interpreter. CAT commands include text and numbers, each CAT command is terminated by a semicolon. CAT commands never include a carriage return (enter).

Note that when the terminal is connected, you can actually type on your keyboard to send CAT commands. For example, try typing FA; (just those three characters – no Enter at the end). The text FA00007074000; will appear on the terminal. FA is the command to read or set VFO A, and the result is 7.074 kHz, the default QMX startup frequency. HOWEVER, this is not a very convenient or easy way to try out CAT commands, there is a CAT command testing application which is much easier to use.

To switch to terminal applications mode, simply press the Enter key on your keyboard. Now the terminal applications mode will appear in your terminal emulator window, as shown below. The screen shows the QMX firmware version (on the bottom line), and a main menu. You may use the cursor keys to move the highlighted application up and down in the list, and press Enter to select an application. Any nested menu or application can be quit by pressing Ctrl-Q which returns the terminal to the main menu screen.

Operation of each of the applications will be described in detail in subsequent sections.

```
+---Main menu-----+
|
| Configuration
| Hardware tests
| PC and CAT
| System
| Exit terminal
|
+-----+

QMX v1_00_009   QRP Labs, 2023
```

8.3 Exiting terminal applications mode

When exiting terminal applications mode, do not simply close the terminal emulator window. Doing so will leave the QMX in terminal applications mode and it will not accept CAT commands. To switch it back to CAT command mode, use the cursor keys to scroll down to the “Exit terminal” option at the bottom of the main menu, and press Enter. The screen is now cleared, and QMX is back in CAT command mode. Only then should you close the terminal emulator window.

8.4 Configuration menu

```
+---Main menu-----+
|+---Configuration-----+
| |
| | Presets
| | Messages
| | CW Keyer
| | CW Decoder
| | Digi interface
| | Beacon
| | Display/controls
| | Protection
| | System config
| | Band configuration
| | Factory reset
| |
| |
+-----+

QMX v1_00_010   QRP Labs, 2023
```

Use the arrow keys to scroll up and down menu items, and the Enter key to select one. The first item on the main menu is “configuration”. The configuration menu shows a list of sub-menus which closely correspond to the menus available on the QMX LCD itself, which were described in a previous section of this manual. In fact, the menus are driven from the same code module and menu structure; the terminal presentation and the QMX LCD/buttons user interface are different views into the same menu and configuration system.

A minor difference is the Band Configuration screen, which is NOT available via the LCD menu (refer to the next section). Furthermore the “Update firmware” option is not shown on the Configuration menu; in the terminal, Update firmware is an item in the “System” menu, not the Configuration.

The default configuration parameters are suitable for the vast majority of operating use.

Use the up/down arrows to select the item you wish to edit. The cursor is positioned at the last character of the value. Numeric values have a defined field length. You can press the backspace key to delete the current entry in whole or in part, and type in the new value. For non-numeric (list) configuration parameters, you can use the left and right arrow keys to choose between the available values. For text entry, you can only type at the end of the text, there is no facility to move back within the text and edit an earlier part of the text line.

Note that entering the Configuration menu in the terminal locks out the Configuration menu on the QMX LCD, and vice versa. Furthermore, in general, as per the configuration menu on the LCD, configuration parameters do not take effect until you leave the Configuration menu system.

Remember to press Ctrl-Q to exit a sub-menu and move to the next higher menu.

Refer to the QMX Configuration (LCD/buttons/knobs) section for details of all the configuration parameters.

8.5 Band configuration

```
+---Main menu-----+
|+---Band configuration-----+
|
| Band name (m)      80      60      40      30      20      0
| Audio gain (dB)   54      54      54      54      54      0
| Frequency min.    3200000  4000000  6000000  7500000  10500000  0
| Frequency center  3573000  5357000  7074000  10136000 14074000  0
| Frequency max.    4000000  6000000  7500000  10500000 14500000  0
| Sweep start       3200000  4000000  5000000  8000000  8000000  0
| Sweep step        20000    50000    50000    70000    130000   0
| BPF number (0-3)  3          3          3          2          1          0
| LPF number (0-2)  0          1          1          2          2          0
| PIN fwd bias (mA) 30         30         30         30         30         30
| Transmit          ENABLED    ENABLED    ENABLED    ENABLED    ENABLED    DISABLED
| TX PTT +5V        DISABLED  DISABLED  DISABLED  DISABLED  DISABLED  DISABLED
| TX PTT grounded   DISABLED  DISABLED  DISABLED  DISABLED  DISABLED  DISABLED
| RX PTT +5V        DISABLED  DISABLED  DISABLED  DISABLED  DISABLED  DISABLED
| RX PTT grounded   DISABLED  DISABLED  DISABLED  DISABLED  DISABLED  DISABLED
|
|-----+-----+-----+-----+-----+-----+-----+-----+-----+
|                                                                    Ctrl-Q = Quit
|
| QMX v1_00_009   QRP Labs, 2023
```

The Band Configuration screen allows specification of all parameters that are handled per-band. This screen is populated by default with the correct information to set QMX up for 5-band operation on 80, 60, 40, 30 and 20m (See above). However, if you wish to experiment with other bands (which will require hardware modifications to Receiver Band Pass Filter and Transmitter Low Pass Filter component values – for which you are on your own), then you may specify the other band parameters here.

There is space for 6 band configurations, which are arranged in columns in a table. You may move from one column to the next by using the left/right arrow keys. Use the up/down arrow keys to move up and down the rows of each band specification column.

Remember that the number of characters in each setting is limited. To change the parameter setting, you generally need to press the Delete key in order to delete the existing setting characters, then enter new ones. The setting is stored in memory when you press the Enter key, or one of the arrow keys to move to a different cell of the table.

As usual, press Ctrl-Q to quit the Band Configuration utility.

An explanation of the items in the Band Configuration screen follows:

Band name (m): The name of the band - this appears in all the other terminal applications such as RF sweep, Transmitter test etc. to identify the set of settings corresponding to the band. The name also determines certain behaviour, as follows.

Audio gain (dB): 54 is the default. Valid values for the parameter are 0 to 99. This makes it easy to choose a gain by band - which is often useful to get WSJT-X and JS8Call perfectly happy on each band without needing to manually fiddle with gain adjustments when changing bands. WSJT-

X and JS8Call documentation recommends when the band is empty, the signal strength meter on the bottom left should be at about +30dB.

Frequency min.: When you command a new frequency via CAT (from WJST-X etc), this is the lower limit of this band definition.

Frequency center: The center frequency, which is the frequency of the vertical blue line seen in the RF sweeps, the test frequency for AF sweeps, and is the frequency used by the Transmitter Test screen. It doesn't have any other purpose and doesn't have to be the actual center (half way between min and max).

Frequency max.: When you command a new frequency via CAT (from WSJT-X etc), this is the upper limit of this band definition .

Sweep start: the start frequency for the RF sweep screen. Note that the minimum measurable frequency is 375 / MS Divider (see Band name section above, for details on MS Divider). If the sweep starts on a non-measurable frequency, the actual graph line will not start until a measurable frequency occurs.

Sweep step: the step frequency for each point of the RF sweep plot screen. Similarly to the above (Sweep start), the maximum measurable frequency is 1150 / MS Divider and points above this are not plotted on the graph.

BPF number (0-3): The Band Pass Frequency selection for this band.

LPF number (0-2): the Low Pass Frequency selection for this band.

PIN fwd bias (mA): Specifies the forward current, in mA, to be driven through each of the two PIN diode switches either side of the Low Pass Filter during transmit. The adjustment range is 5 to 60mA. The default value is 30mA and should generally be left alone.

Transmit: Enabled or Disabled, to allow or prevent transmission on this band. Press the E key to enable, D key to disable.

TX PTT +5V: To enable or enable, for this band, whether +5V appears on the PTT connector "ring" connection during transmit. Press the E key to enable, D key to disable.

This output is designed to directly interface with the QCX-series 50W Power Amplifier with a simple stereo jack audio cable. Remember, the 50W PA is a SINGLE BAND amplifier so should only be used on the QMX with a single band, unless you are going to build an external switched Low Pass Filter. Also remember that the 50W QCX-series amplifier is designed for CW operation and not suitable for the high duty cycle of digital modes; therefore if you wish to use this with the QMX transceiver in digital modes, be sure to limit it to around 20-25W output power; this will be achieved by using a 12V supply voltage to the 50W PA kit.

TX PTT grounded: To enable or disable, for this band, whether the PTT "tip" connection is grounded during transmit. Press the E key to enable, D key to disable. This PTT output is suitable for driving a typical grounded PTT type amplifier.

Please refer also to the hardware documentation (assembly manual) for more information on the PTT connection, and the circuits driving it.

The PTT connector is a 3.5mm stereo jack connector. The "ring" connection can be configured as a +5V PTT output, suitable for switching the QCX-series 50W amplifier. The "ring" connection is also used on the 50W PA so only a standard stereo audio jack cable is required. The "tip" connection can be configured as a grounding PTT output for connection to most other amplifiers.

Both the +5V-going and grounded PTT outputs ('ring' and 'tip' connections respectively) are MOSFET open-drain outputs (utilizing P-channel and N-channel type MOSFETs respectively). Both outputs have a 470-ohm resistor in series to protect them against accidental damage for example, shorts to ground.

RX PTT +5V: To enable or enable, for this band, whether +5V appears on the PTT connector "ring" connection during receive. Press the E key to enable, D key to disable. Generally for use with an external PA, these settings should all be left DISABLED. However if you wish use the +5V output for some auxiliary control purpose such as a relay for external switching of antennas, then you can configure it to be active during Receive as well as transmit.

RX PTT grounded: To enable or disable, for this band, whether the PTT "tip" connection is grounded during receive. Press the E key to enable, D key to disable. Generally for use with an external PA, these settings should all be left DISABLED. However if you wish use the grounded output for some auxiliary control purpose such as a relay for external switching of antennas, then you can configure it to be active during Receive as well as transmit.

8.6 Hardware tests menu

The hardware tests menu contains several very useful tools which can be used to optimize your QMX, diagnose faults, and learn more about the QMX. The Band Configuration application is also available on this menu, to make it easier to make changes if you need to while using the tools.

8.6.1 Audio filter sweep

QMX contains its own internal signal generator, which can be used to sweep the audio passband of the receiver, checking the audio response and the unwanted sideband cancellation.

A dummy load must be connected for valid results.

On entering the application, a sweep automatically commences. The percentage completion of the frequency sweep is indicated in the bottom right corner of the screen.

The sweep starts at 100 Hz (injected signal is 100 Hz higher than the "USB Dial Frequency", then proceeds in 50 Hz steps up to and including 3850 Hz. The RF frequencies ("USB Dial Frequency") used for bands are defined in the Band Configuration screen of the QMX. For example, for 80, 40, 30 and 20m are 3.573, 7.074, 10.136 and 14.074 MHz respectively. The vertical axis shows audio decibel (dB) level. The offset is arbitrary. Gridlines axis are displayed in blue. Vertical gridlines are every 20dB, and horizontal axis gridlines every 1000 Hz. Gridline labels are displayed in blue; the minimum and maximum audio level (in dB) displayed in white, and the maximum audio sweep value also displayed in white.

The chart contains two lines, the line of yellow asterisks is the Upper Sideband (USB) and the red line is Lower Sideband (LSB). In the default demodulation mode (USB), we expect to see the yellow line nice and flat between the filter cut-off points 150 Hz to 3.2 kHz. The red line is the unwanted sideband and we expect to see it around 60dB below the wanted sideband.

The – and + keys can be pressed to move down and up to adjacent bands defined in the Band Configuration screen. Generally the result should not differ much from one band to the next.

An additional hidden feature of this screen is that you can press the dot key on your keyboard, and the gridlines will cycle through the available terminal colours! It may make the gridlines easier to see on some terminal emulators.

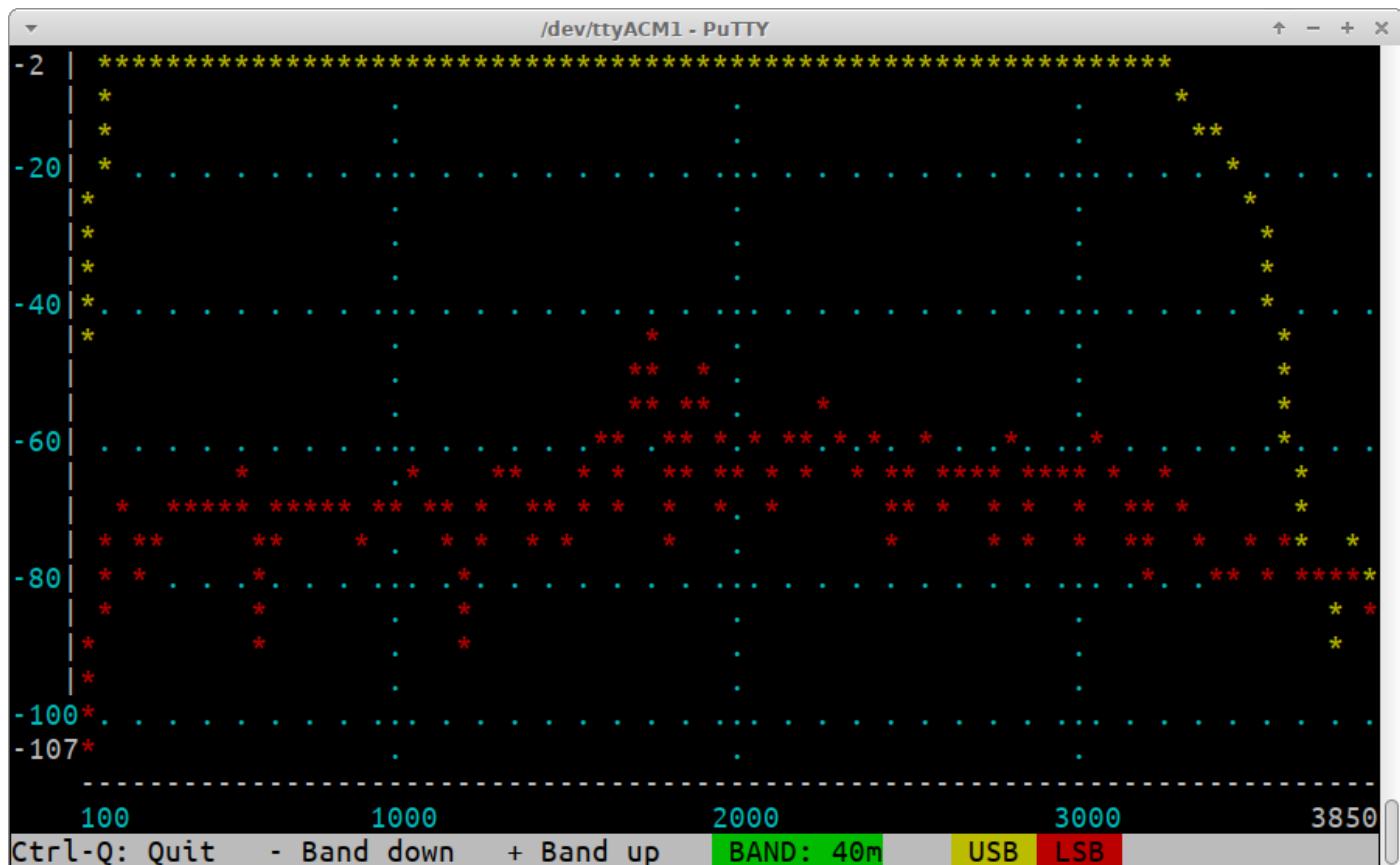

8.6.2 RF filter sweep

QMX contains its own internal signal generator, which can be used to sweep the receiver input Band Pass Filters, checking its response and center frequency. Though the difference in performance is small, the perfectionist may wish to adjust (by squeezing turns) the Band Pass Filter inductor L401 to optimize the center frequencies of the filters.

A dummy load must be connected for valid results.

On entering the application, a sweep automatically commences. The percentage completion of the frequency sweep is indicated in the bottom right corner of the screen.

The center frequency and sweep width are defaulted appropriately per band, to show several MHz of frequency sweep cleanly, and are not adjustable. The vertical axis shows audio decibel (dB) level. The offset is arbitrary. Gridlines axis are displayed in blue. Vertical gridlines are every 20dB, and horizontal axis gridlines as appropriate to the band. Gridline labels are displayed in blue; the minimum and maximum audio level (in dB) displayed in white.

A vertical line is shown at the position corresponding to the default operating frequency in the current band. Ideally the peak of the response (line of yellow asterisks) should coincide with the center frequency of the band. The filters are not very very sharp so the performance degradation by being slightly off frequency is not severe.

The – and + keys can be pressed to move down and up to adjacent bands as defined in the Band configuration screen. Pressing the R key re-runs the sweep on the existing band. Again, a hidden feature is the use of the dot key to change the gridlines colour.

The following screenshots show typical performance, which may vary from device to device. Do not worry that 60 and 80m are not peaked; sensitivity is less of an issue anyway on low bands.

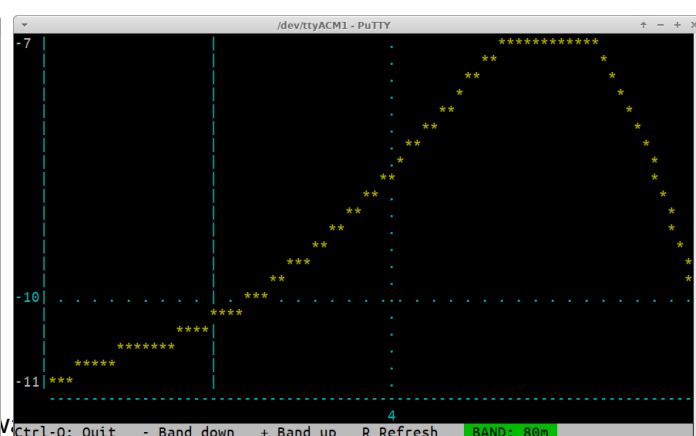
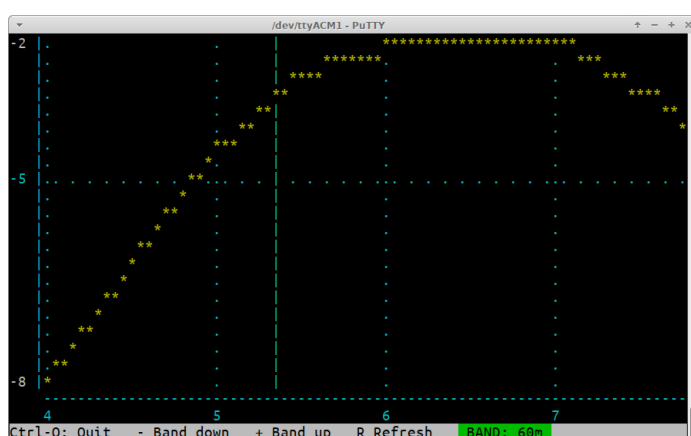
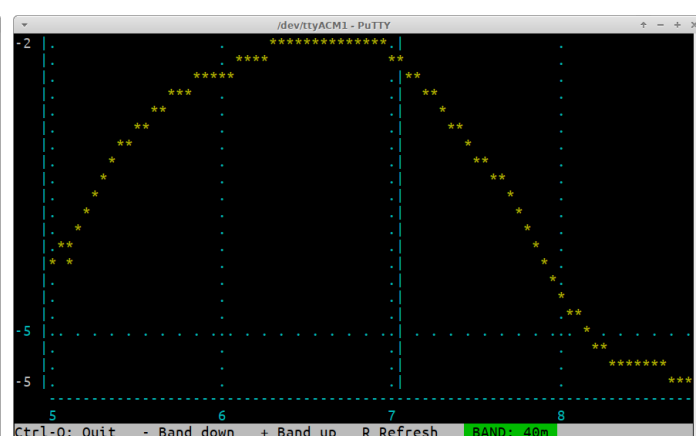
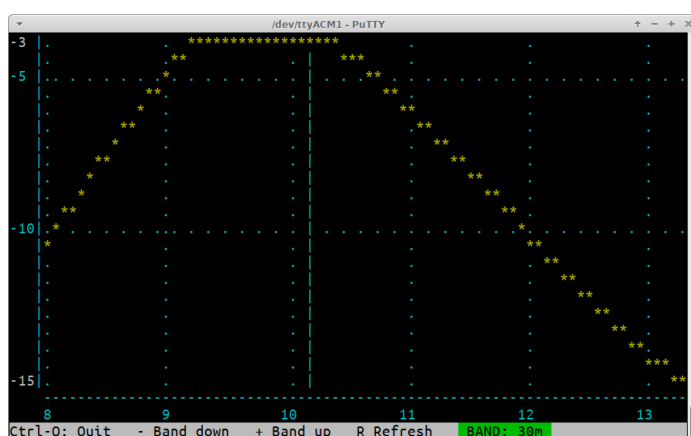
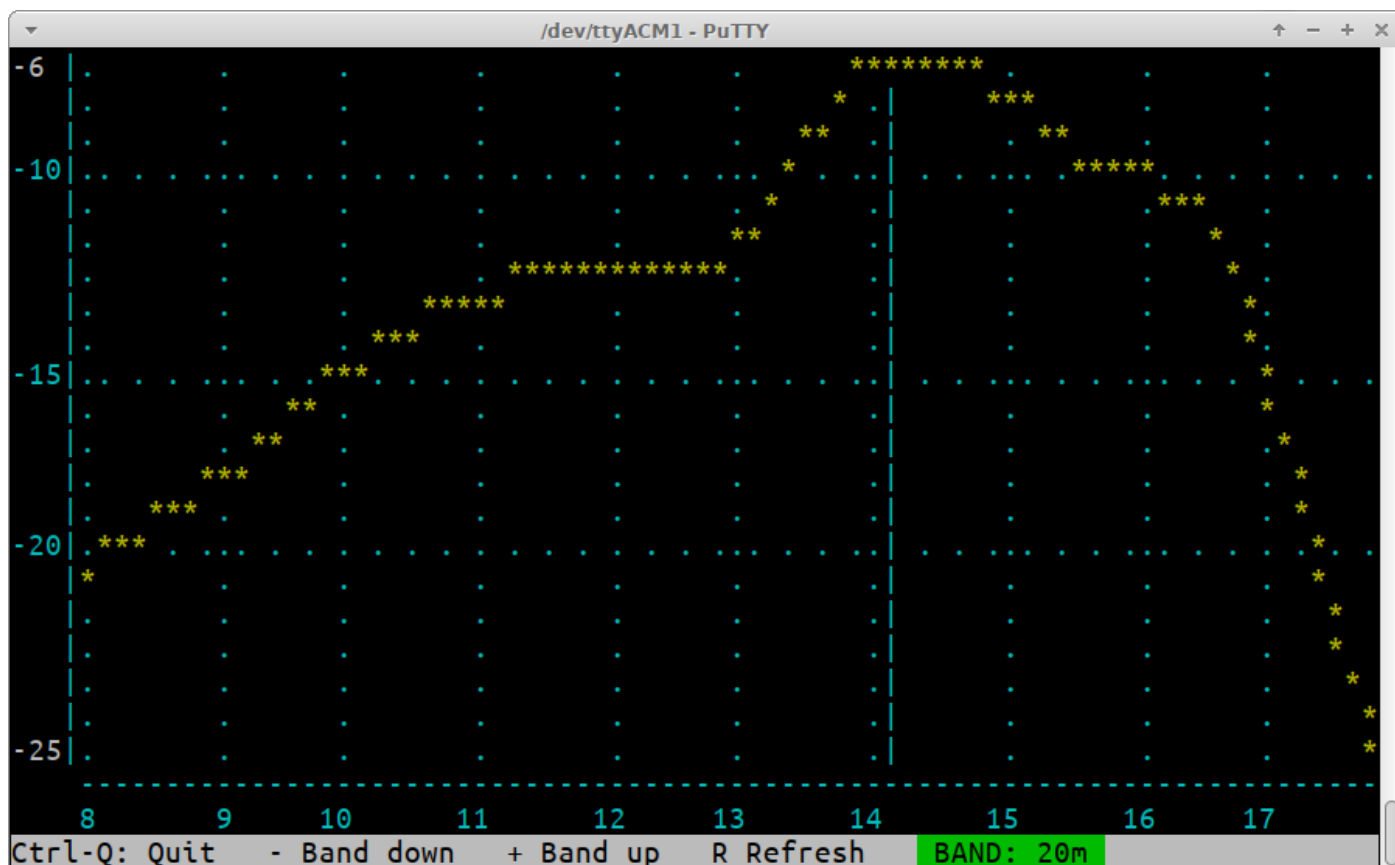

8.6.3 Image sweep

QMX implements a conversion to baseband, sampling quadrature I and Q channels at 48ksps to a 24-bit stereo ADC then the rest of the receiver is done in Digital Signal Processing in the microcontroller – a Software Defined Radio (SDR). The SDR implements a superhet with 12kHz IF. Like any superhet, this means that there is an image response on the other side of the IF frequency. In this case, that means the image response is 24kHz down the band. The amount of the image rejection depends on:

- Amplitude balance between the I and Q channels
- Any phase error in the 90-degree quadrature relationship

In QMX to date, no attempt is made to compensate for these errors. The image rejection has been found to be adequate without it. A future firmware version will likely include automatic adjustments to improve image rejection.

In the image rejection screen, the VFO to the band center frequency as defined in the Band Configuration screen, then sweeps the signal generator input from -30.5kHz (below) to +7kHz (above). An example of the resulting sweep is shown below:

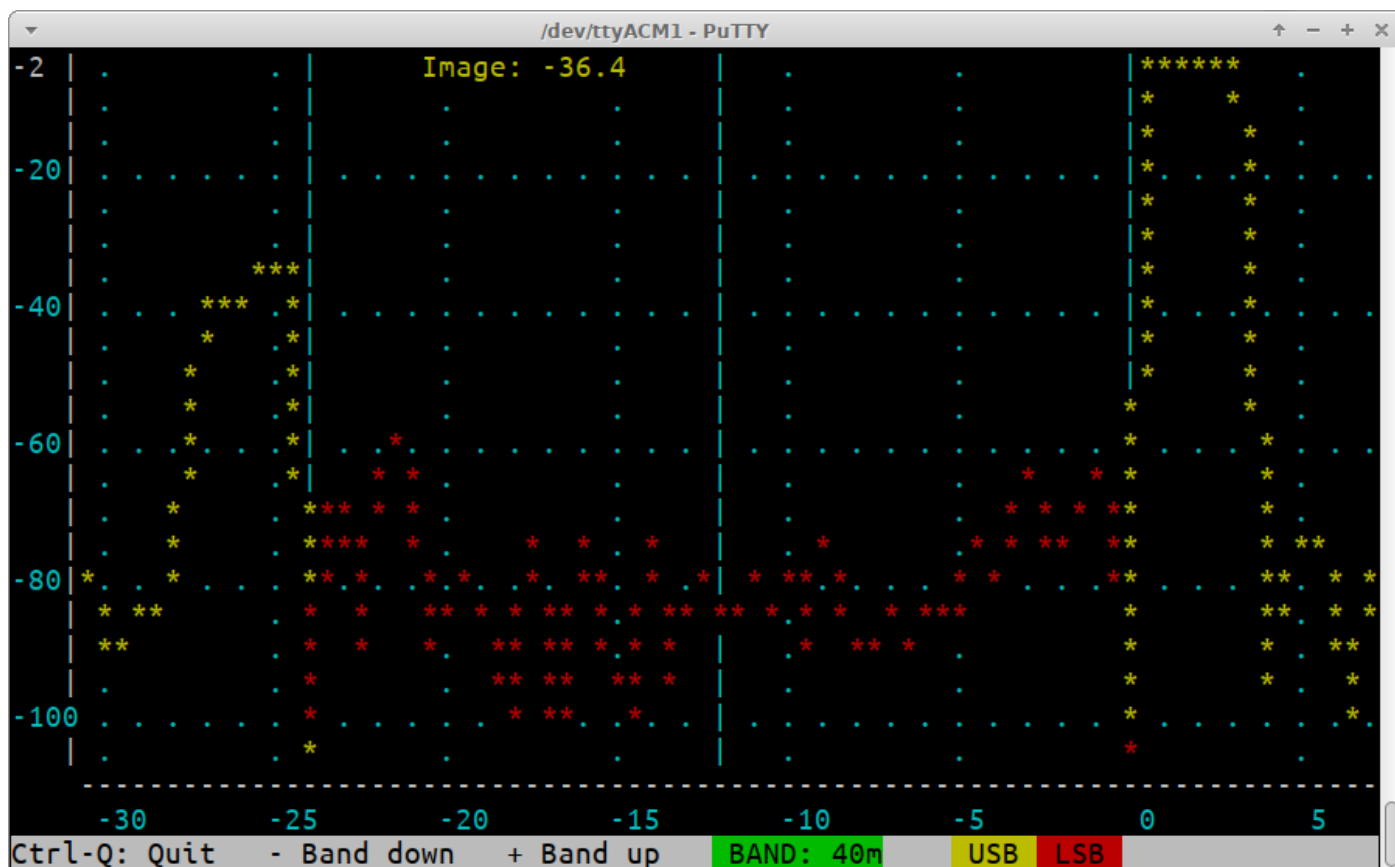

You may get better or worse image rejection than this (depending on your particular combination of component tolerances) and toroid winding style. This is not normally something to worry about.

However if you have a significantly worse image rejection then it is time to start debugging your unit; most likely is a problem in the area of the trifilar transformer. Faults such as incorrect wiring (wires in the wrong holes), a broken wire, shorts between wires, etc., can all cause this.

In this annotated image, the four audio responses are identified; all four appear in the receiver's audio passband. When everything is correct, the three unwanted ones (the lower sideband and the USB/LSB at the image frequency) are at a much lower signal level than the wanted in-channel USB reception.



8.6.4 SWR sweep

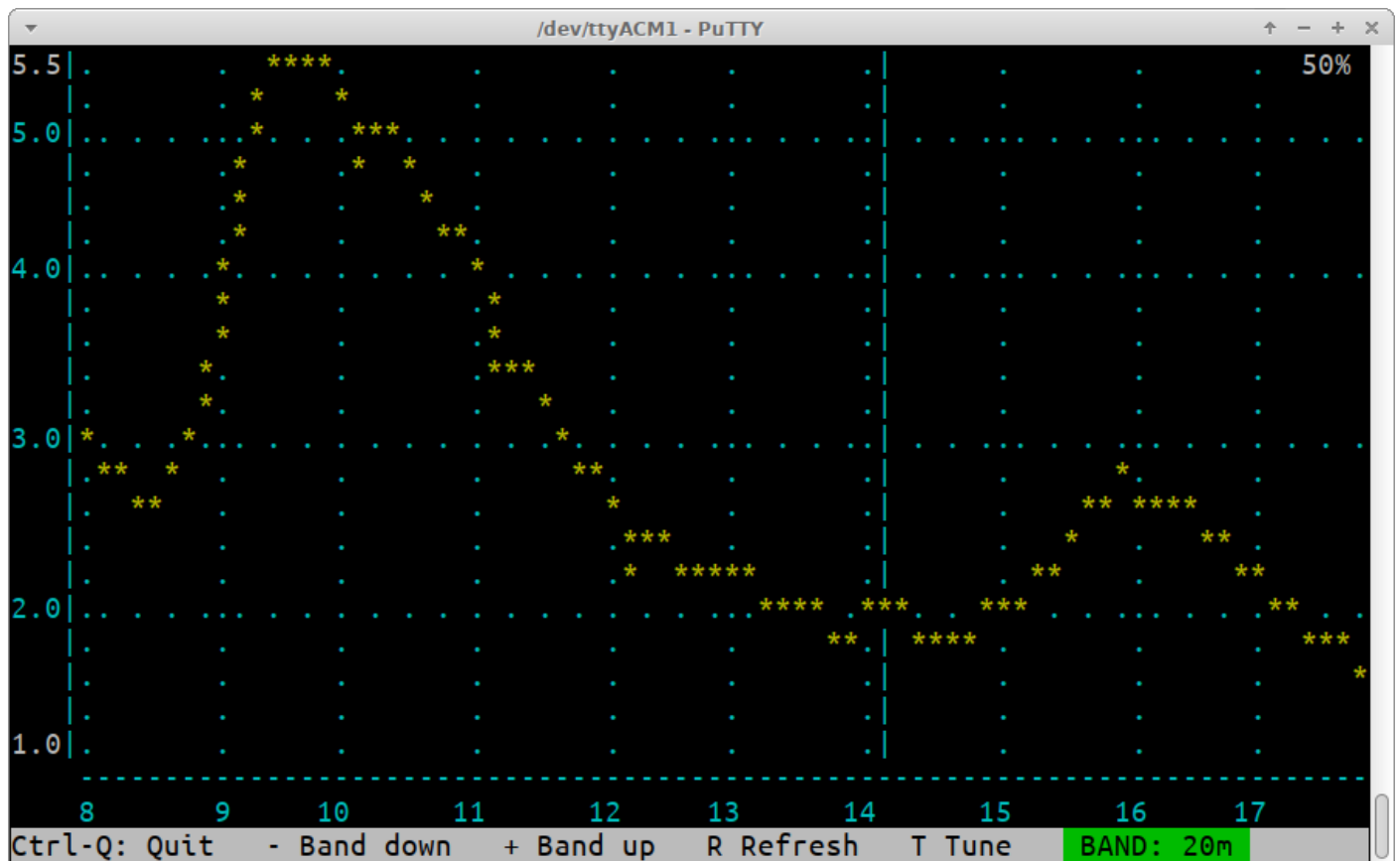

The SWR sweep tool has the same frequency range as the RF sweep tool; it displays the measured SWR at each frequency. During the sweep the PA voltage is set to a proportion of full power voltage determined by the "Tune %" parameter in the Protection menu. Remember that due to the square-law relationship between voltage and power, when the voltage is halved the power output is one quarter of full power. If the power is too low, the SWR measurement will be

inaccurate. If the power is too high, then during high SWR parts of the curve, stress may be placed on the PA transistors. The PA voltage percentage is displayed in the top right corner of the screen.

The vertical axis shows the measured SWR level. Gridlines axis are displayed in blue. Vertical gridlines are every 1 SWR, and horizontal axis gridlines as appropriate to the band. Gridline labels are displayed in blue; the minimum and maximum displayed in white.

A vertical line is shown at the position corresponding to the default operating frequency in the current band. Ideally the point of minimum SWR of your antenna system should coincide with the center frequency of the band.

The – and + keys can be pressed to move down and up to adjacent bands as defined in the Band configuration screen. Pressing the R key re-runs the sweep on the existing band. Again, a hidden feature is the use of the dot key to change the gridlines colour.

Press To tune, this activates the transmitter at the band center frequency, at the reduced power output, and displays a realtime SWR measurement in the bottom right corner of the screen.

8.6.5 Diagnostics

This is a powerful tool for diagnosing hardware problems.

Several areas of the screen show a colour coding. Green means the operation is correctly within allowable parameters, and it's a "PASS". Red means the operation is outside allowable limits, or that the function has not been tested yet.

The screen is divided up into several areas which will be described in turn.

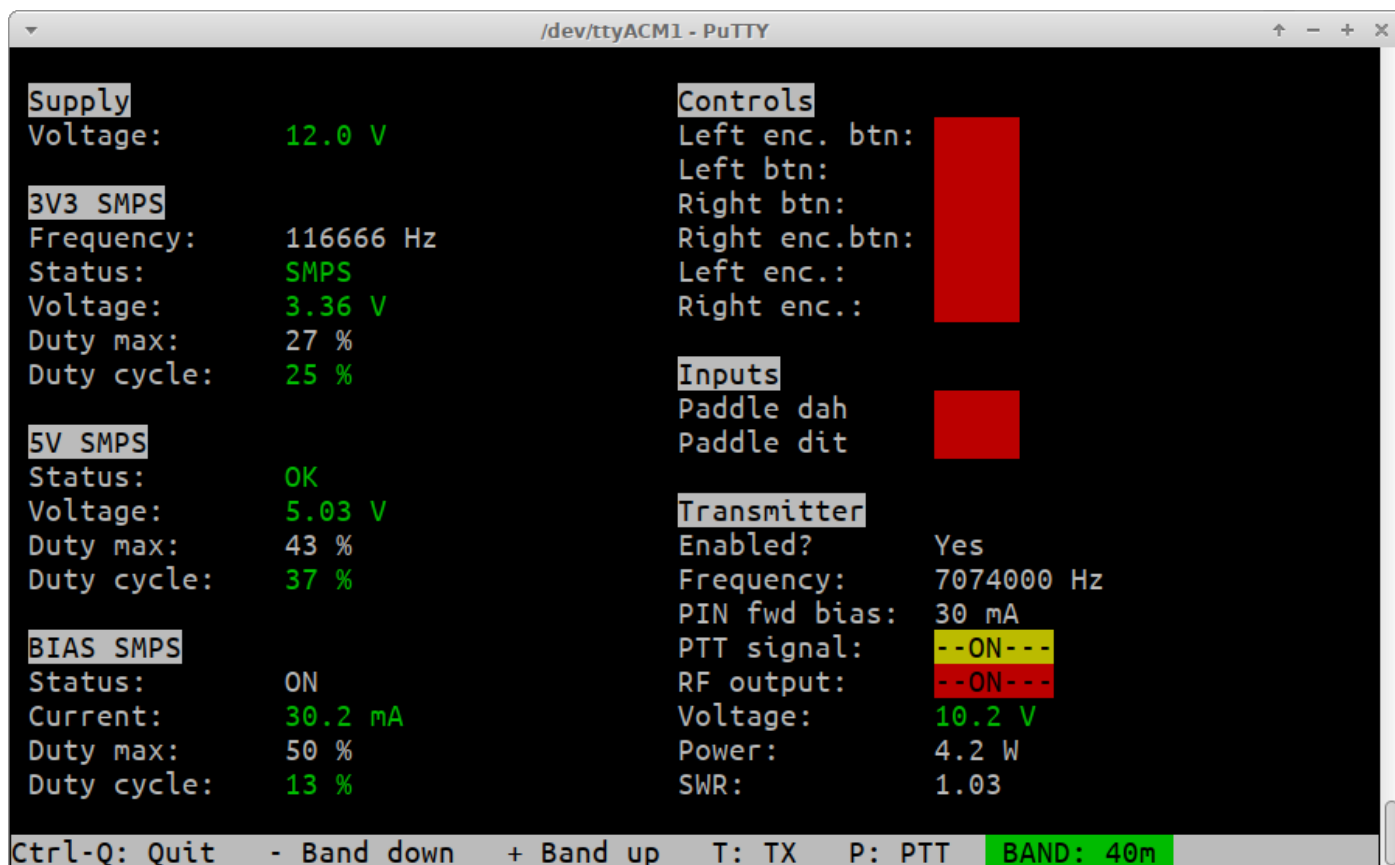

Supply

Displays the measured supply voltage. The "OK" range is 6.0 to 12.5V.

3V3 SMPS

The current operating parameters of the 3.3V buck converter, including the operating frequency - which actually applies to all three buck converters, which are on the same frequency. "Status" is either "SMPS" or "Linear" depending on whether the buck converter or the Linear regulator (78M33) is being used. After the initial 0.25 seconds start-up procedure, it should always be SMPS if everything is OK. You can also see the live measured voltage, the current duty cycle and the maximum duty cycle which the system will allow to be set, for the current measured supply voltage.

5V SMPS

The same information for the 5V buck converter; the status is OK if it is running normally (after the first 0.25 seconds), or "Error" if there is a problem; again you can see the measured voltage, and the current duty cycle and maximum allowed duty cycle (expected performance envelope).

BIAS SMPS

Similar information for the PIN diode TX forward bias current buck converter; this is only ON when you key the transmitter. In this case the measured (and calculated) current is indicated, and the current duty cycle; the maximum allowed duty cycle is in this case currently always 50% regardless of supply voltage.

Controls

You can test all the controls of the QMX here; the four buttons (including the two on the shafts of the rotary encoders), and the clockwise/anticlockwise operation of the rotary encoders (indicated as >>> and <<< respectively). When you open the hardware diagnostics testing screen the six rows are all red; then as you press each button, and rotate the encoders in both directions, you can get the red to disappear.

Inputs

These are the paddle dit and dah inputs (ignoring the Keyer menu "Keyer swap" setting); again they are red until you tap the dit and dah of the paddle.

Transmitter

The Transmitter Test terminal application is useful for verifying correct operation of your transceiver, and making output power measurements into a dummy load, directly from the terminal rather than needing to use WSJT-X's "Tune" button. It has the same functionality as the "Transmitter test" screen in the QDX transceiver.

The following keys are used in the Transmitter test application:

- + increases the band
- decreases the band
- p Enable PTT (Highlights in YELLOW)
- t Enable PTT and transmit (highlights in RED)

This section shows whether or not the band is enabled for Transmit, the default center frequency, and PIN fwd bias (see Band Configuration screen). When you press P or T, you should see the "BIAS SMPS" section of the screen spring into life and the current measurement should be within a couple of mA of the configured PIN fwd bias setting. Additionally, the PA voltage is measured,

after the RF envelope shaping (amplitude modulation). In transmit, this should be a little less than the supply voltage measurement. In receive, it should be near to zero volts. The PA voltage is coloured green or red depending on whether it is within a reasonable operating range or not.

Power and SWR are also measured when the T key is pressed to cause transmit; this transmit is done at the full PA voltage and there is no SWR protection. A dummy load should normally be used when running the diagnostics screen.

Faultfinding

Under some circumstances, the diagnostics screen can also be a useful aid in initial debugging of the QMX transceiver.

After power-up, the system boots up on the linear 3.3V regulator (78M33). During the first half second, the system brings up the buck converters (3.3V and 5V power rails) and switches off the linear 3.3V regulator.

IF there is a fault on any of this, QMX will not start; it will not start the receiver or transmitter, and will not power the LCD module or write anything to the LCD.

However, QMX **will** start the USB Virtual COM Serial port connection, even from the start when it is still powered via the 3.3V linear voltage regulator. When you connect a terminal emulator, QMX will display this diagnostics screen. You may be able to see from the displayed values (and colouring) where the fault lies.

8.6.6 GPS viewer

The GPS viewer is a very cool way to display the information parsed from a connected GPS such as the QRP labs QLG2. It may not be particularly critically useful but it may be interesting to you! To make use of this application you will need to have plugged a QLG2 (or similar) GPS module into the paddle port, with 1pps and 9600 baud serial data.

The tip of the 3.5mm jack plug is 1pps and the ring connection is 9600-baud serial data. This is also the default output of either the QLG1, QLG2SE or QLG2 QRP Labs modules, including the current QLG2 <http://qrp-labs.com/qlg2> which is an option when you order QMX.

The older QRP Labs module QLG1 receives only GPS satellites; the current QLG2 (and former QLG2SE) modules receive 2 satellite networks, which by default are GPS (American) and Beidou (Chinese); they are also capable if commanded, of changing to Glonass (Russian) or Galileo (European).

An example display is shown above. There are three panels: top left, some parsed information from the GPS data; bottom left: a list of all the satellites being tracked. There are five columns of numbers which are:

- Satellite ID
- Elevation angle
- Azimuth angle
- SNR
- Satellite constellation

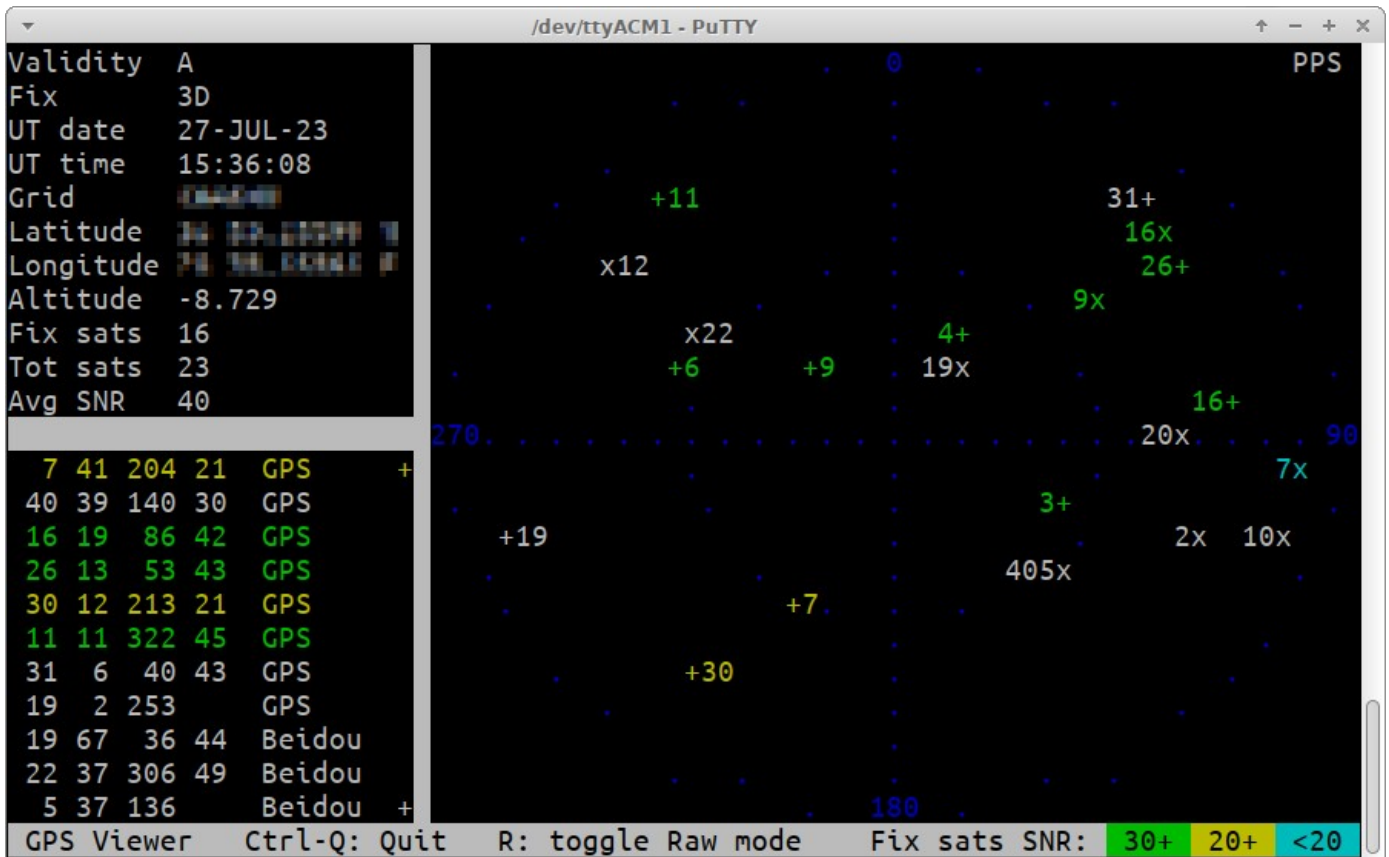

There is a + at the top right of the satellite list panel if you can use the up arrow to scroll up, and a + at the bottom right if you can use the down arrow to scroll down. The example shown here is a QLG2 with its standard active outdoor patch antenna and this is why you see very high SNRs, lots of satellites and both GPS and Beidou. The right-hand panel shows a sky map with all the satellites plotted on it.

The colour encoding indicates SNR of the satellites used in the fix calculation; Green for 30+ dB, yellow for 20+ dB and blue for <20dB. White means it is being tracked but isn't used in the GPS module's fix calculation for whatever reason best known only to itself. Additionally on the map you'll see a series of blue dots at 0, 90, 180 and 270-degree axis which are also labelled in blue, and two concentric circles for the horizon and 45-degree elevations, 90-degrees being the center point.

- + indicates a GPS satellite
- x indicates a BDS (Beidou) satellite
- o would be for GLONASS satellites
- * would be for Galileo satellites

The satellite ID is written to the right of the satellite point for all satellites to the west, and on the left for satellites to the east.

There's a "PPS" text written in the top right corner of the screen which inverts when the PPS signal is active (high).

You can also press R to toggle a "raw" mode which opens a 4th panel, showing ten rows of scrolling raw NMEA data; the map plot panel then resizes into a smaller map in the top right corner. The maps are necessarily an approximation of positions because this is an 80 x 24 terminal, not a graphic display. Please see below for an example screenshot.

The "GPS Viewer" application is also available in the "Hardware tests" sub-menu on the LCD/buttons/rotary encoders of the QMX itself, and contains three screens which you can scroll

through by turning the right encoder. They show a general information summary screen, a Latitude/Longitude screen, and a screen showing Grid subsquare and Altitude. In the LCD version of the GPS viewer there's a "heartbeat" icon which pulsates in time with the 1pps, when on the general information screen. Please refer to section 4 of this manual.

```

/dev/ttyACM1 - PuTTY
Validity A          9 63 313 36 GPS
Fix 3D             4 61 29 48 GPS
UT date 27-JUL-23 3 49 114 38 GPS
UT time 15:36:26  6 42 290 48 GPS
Grid [REDACTED]   7 41 204 19 GPS
Latitude [REDACTED] 40 39 140 29 GPS
Longitude [REDACTED] 16 19 86 42 GPS
Altitude -8.729   26 13 53 44 GPS
Fix sats 16       30 12 213 23 GPS
Tot sats 23       11 11 322 45 GPS
Avg SNR 40        31 6 40 43 GPS
                19 2 253 GPS
                19 67 37 44 Beidou +

GPS Viewer Ctrl-Q: Quit R: toggle Raw mode Fix sats SNR: 30+ 20+ <20
$GPGSV,3,3,12,30,12,213,23,11,11,322,45,31,06,040,43,19,02,253,*70
$BDGSV,3,1,11,19,67,037,44,22,37,306,49,05,37,136,,09,31,047,44*66
$BDGSV,3,2,11,20,28,093,47,02,19,113,,06,15,048,44,16,13,047,46*6B
$BDGSV,3,3,11,12,12,309,35,07,02,098,,10,02,107,*55
$GNRMC,153626.000,A,[REDACTED],0.000,24.32,270723,,D*7C
$GNVTG,24.32,T,,M,0.000,N,0.000,K,D*11
$GNGGA,153627.000,[REDACTED],2,16,0.68,-8.729,M,34.505,M,,*5A
$GPGSA,A,3,06,11,07,09,16,26,30,03,04,,,0.97,0.68,0.70*0A
$BDGSA,A,3,06,22,19,20,09,12,16,,,,,0.97,0.68,0.70*15
$GPGSV,3,1,12,09,63,313,36,04,61,029,48,03,49,114,38,06,42,290,48*72
  
```

8.7 PC and CAT menu

This menu contains several items related to the PC interface and CAT commands.

```

+---Main menu-----+
|+---PC and CAT-----+
|
|  System config
|  Input analysis
|  CAT command test
|  CAT monitor
|  Log file
+|
+-----+
  
```

QMX v1_00_009 QRP Labs, 2023

8.7.1 System config

The system config menu is the same menu of parameters that is accessible within the Configuration menu. Please refer to the System Config part of section 4 of this manual.

8.7.2 Input Analysis

The Input analysis application is one of the most interesting screens in the QMX Terminal application suite. It shows a “waterfall” which scrolls upward, with the measured audio frequency shown as a yellow block in each row, with its horizontal position determined by its frequency. The scroll rate, and the screen width, are adjustable. The application can be used for checking the accuracy of the frequency analysis (for example when changing configuration parameters “Minimum cycles” and “Minimum samples” at various incoming audio frequencies).

Keyboard controls

During operation, the following keyboard buttons may be pressed to control the operation of the waterfall:

- CTRL-Q: Quit the input analysis application
- Right arrow: Increase the screen width (higher number of Hz per horizontal division)
- Left arrow: Decrease the screen width (lower number of Hz per horizontal division)
- Up arrow: Scroll faster (shorter time interval per vertical division)
- Down arrow: Scroll slower (longer time interval per vertical division)
- Space bar: Pause or un-pause the display; when paused the top right corner text shows “PAUSED” in inverted yellow text
- . (dot): Change the colour of the background gridlines. The default colour is blue. Each time the dot is pressed, the colour changes; it cycles through: Blue, Magenta, Cyan, White, Red, Green, Yellow and then blue again.



Display elements

This annotated screenshot illustrates the various elements on the display.

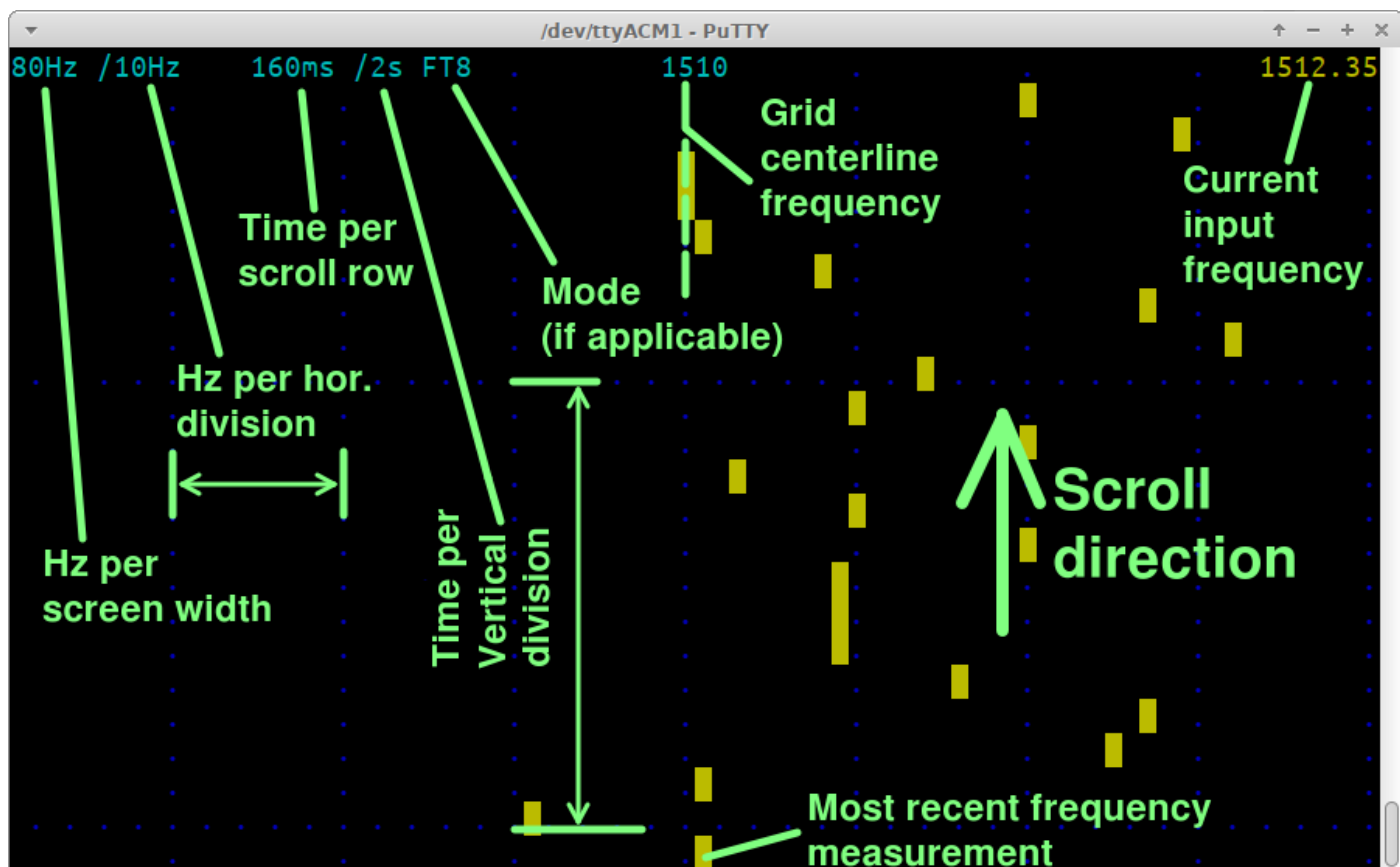

The display elements on the top row are:

- **80Hz:** Total 80-column screen width, in Hz. In this case an 80 Hz wide screen means each block is a 1 Hz Waterfall bucket
 - **/10Hz:** Hz per horizontal division. There are always 8 horizontal divisions on the screen. This parameter displays the number of Hz per division.
 - **160ms:** the update rate of the screen, or put another way, time per horizontal scroll row.
 - **/2s:** The time per vertical division of the screen (distance between the horizontal blue dot grid lines)
 - **FT8:** The mode matching this update rate; various popular modes coded and when an update rate matches a mode, the mode name is written here. See below for the list of supported update rates.
 - **1510:** Center frequency of the waterfall
 - **1512.35:** The most recent frequency measurement
- NO SIGNAL:** displayed at the top right when no audio signal is detected
PAUSED: displayed at the top right when the screen is paused by the space bar

NOTE: At very fast update rates, which are useful for displaying some features, the screen update is too slow to display all the information and still be capable of updating fast enough. Therefore information is dropped. At 20ms per row (50 row updates per second) the only text on the display is “20ms” in the top left corner; the grid lines are still displayed. At 10ms (100 row updates per second), even the grid lines are dropped; only “10ms” is written in the top left corner, and the yellow block drawn for the measured frequency.

Update rates:

The available update rates (selected by the up/down arrow keys) are chosen to match various popular modes. For example, the symbol duration for FT8 is 160 ms. So “FT8” is written next to the vertical division rate, on the top row of the display.

Update rate (ms)	vertical Div (s)	Matching mode	Comment
10	1		Only display “10ms” in top left
20	1		Only display gridlines and “20ms” in top left
40	1		
80	1		
160	2	FT8	
227	2	JT4	
361	5	JT65	
576	5	JT9	
683	5	WSPR	

Horizontal size (Hz):

The available horizontal screen size (selected by the left/right arrow keys) are chosen to cleanly fit the 80 columns display width.

Screen width (Hz)	Horizontal Div (Hz)
12	1.5
20	2.5
40	0.5
80	1
160	2
320	4

Demonstration of sliding frequency changes

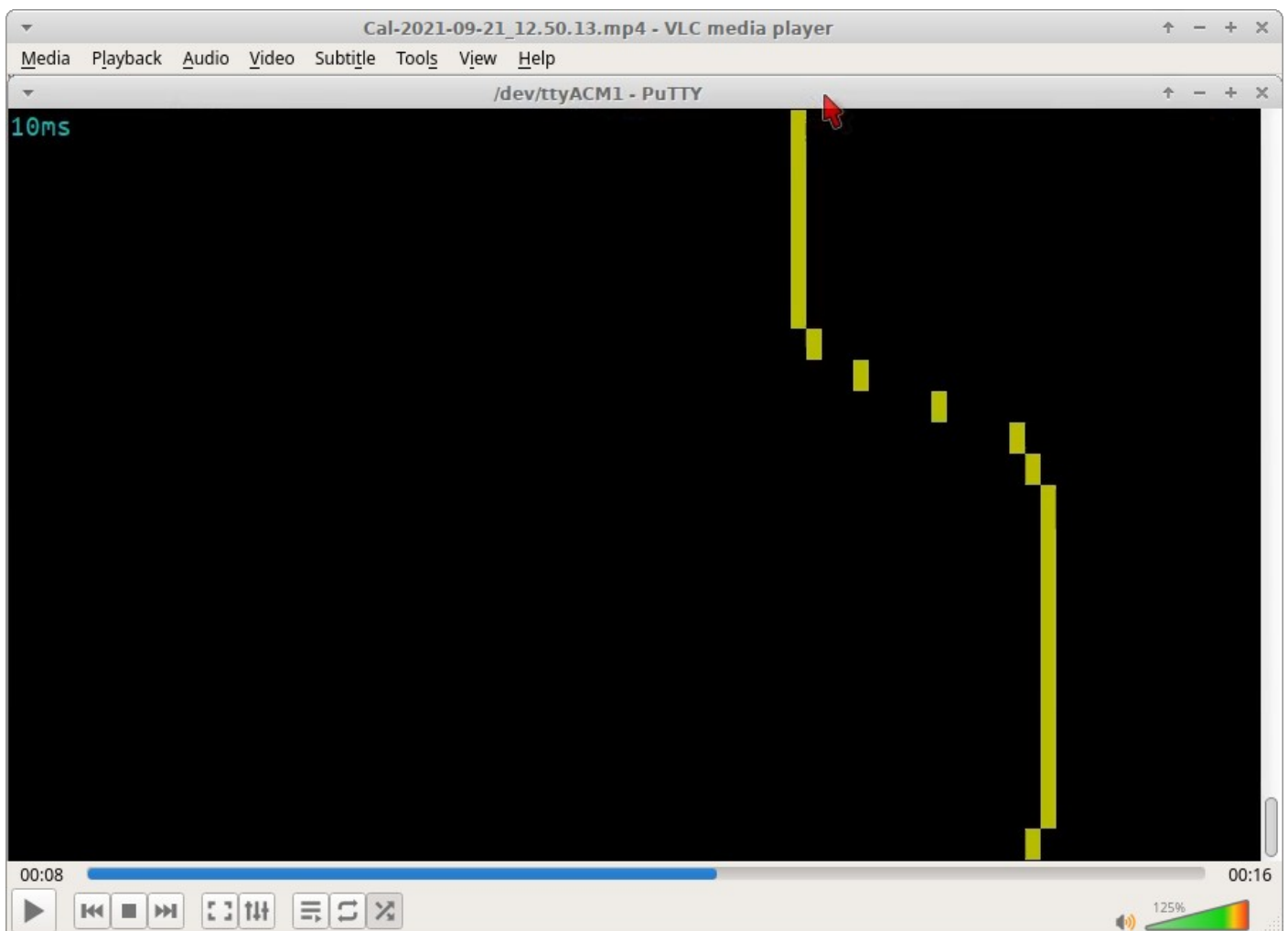

A fun and useful demonstration of the capabilities of QMX and the Input Analysis application, is to investigate the FT8 tone change transition. We know according to the WSJT-X documentation that to avoid splatter onto adjacent frequencies, WSJT-X makes a smooth transition between one tone symbol and the next. It's nice to be able to check this using the Input Analysis screen.

Here the screen width is 80Hz so each horizontal column is a 1 Hz bucket. The FT8 symbol change event is 2 tones (a frequency change of 12.5 Hz since the FT8 tone spacing is 6.25 Hz. The scroll rate is sped up the fastest rate, 10 ms per horizontal row (100 frequency measurements per second).

We see clearly that at the moment the FT8 tone changes, the measured frequency smoothly changes in the expected way from one tone to the next.

Note that an even smoother transition could be made, by setting the “Minimum samples” parameter to 240 samples – this would result in slightly lower accuracy measurement but a smoother transition in tones.

We’re talking here about tradeoffs in different aspects of performance; either way the performance is excellent and QMX keeps up with the changes in input frequency! So this is a nice confirmation of the excellent performance characteristics of QMX.

8.7.3 CAT command test

The CAT command test application is a simple screen which allows you to test CAT commands. An annoying thing about typing CAT commands directly into a terminal emulator when QMX is in the normal operating mode, is that you cannot see the command you are typing, nor can you edit it if you made mistakes.

Here in this simple application, you can type the command (or commands) you wish to send to QMX in the yellow area of the bottom row. If you forget the trailing semicolon, the application adds one automatically for you. Then simply the command is shown in yellow in the left column, and the command result in yellow in the right column. When the screen is full, it will scroll automatically. Naturally unrecognized CAT commands simply return an error ? as per the CAT specification.

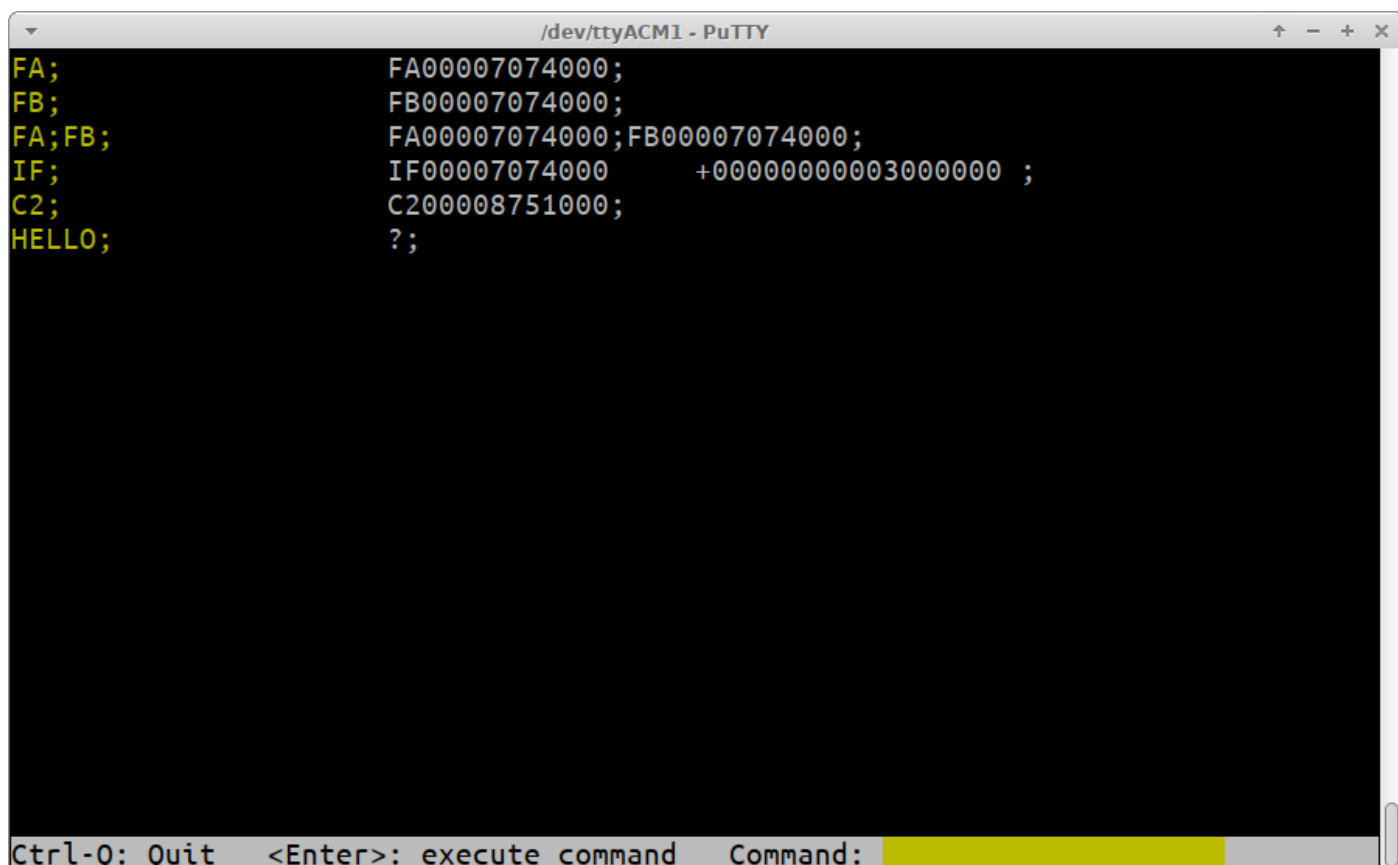

The screenshot shows a terminal window titled "/dev/ttyACM1 - PuTTY". The terminal displays the following output for various CAT commands:

```
FA;          FA00007074000;
FB;          FB00007074000;
FA;FB;      FA00007074000;FB00007074000;
IF;         IF00007074000    +000000000003000000 ;
C2;         C200008751000;
HELLO;      ?;
```

At the bottom of the terminal, there is a prompt area with the text "Ctrl-Q: Quit <Enter>: execute command Command:" followed by a yellow highlight.

Cat command set

QMX implements a subset of the Kenwood TS-480/TS-440 CAT command set which is an old standard, but contains all the necessary commands for WSJT-X and other software to be able to control QMX, and is old enough that it is widely supported by most software packages.

Additionally QMX provides an extended set of CAT commands Q0, Q1, Q2 and so on until QB. These commands allow a host program to set and get various configuration parameters of QMX. Parameters set by the Q commands are not saved in EEPROM, they are valid for the current operating session only. These commands could be useful for example, if you wish to provide a particular start-up script of CAT commands in your PC software to configure your QMX a certain way.

The following lists the commands and responses in alphabetical order:

AG: Get/Set AF Gain

Set: Sets the audio gain. The actual gain setting is the supplied gain in dB. So for example command AG21; will set the gain to 21dB, in the currently active band. Note that the gain can also be set in the Terminal Band Configuration application.

Get: Returns the audio gain in dB.

C2: Get/Set Signal Generator frequency

Set: Sets the Si5351A Clk2 output frequency (the signal generator).

Get: Gets the frequency of Si5351A Clk2 (the signal generator)

FA: Get/Set VFO A

Set: Sets VFO A value. Example: FA7030000; sets VFO A to 7.030MHz

Get: Returns the VFO A contents as an 11-digit number. Example: "FA;" returns "FA00007030000;"

FB: Get/Set VFO B

Set: Sets VFO B value. Example: FB7016000; sets VFO B to 7.016MHz

Get: Returns the VFO B contents as an 11-digit number. Example: "FB;" returns "FA00007016000;"

FR: Get/Set Receive VFO Mode

Set: Set VFO Mode: 0, 1, 2 correspond to VFO A, VFO B or Split respectively. This is the case for both the FR and FT commands (which are nominally Receive and Transmit VFOs) because in the QMX the VFO mode use does not correspond exactly to TS-480.

Get: Get Receive VFO Mode: 0 means VFO A is used for receive (could be due to VFO mode being VFO A, or VFO Mode being Split); 1 means VFO B is being used for receive (must be VFO Mode B).

FT: Get/Set Transmit VFO Mode

Set: Set VFO Mode: 0, 1, 2 correspond to VFO A, VFO B or Split respectively. This is the case for both the FR and FT commands (which are nominally Receive and Transmit VFOs) because in the QMX the VFO mode use does not correspond exactly to TS-480.

Get: Get Transmit VFO Mode: 0 means VFO A is used for transmit (must be VFO Mode A); 1 means VFO B is being used for transmit (could be due to VFO mode being VFO B, or VFO Mode being Split)

FW: Get filter bandwidth

Get: Always returns 3200 meaning, 3200Hz (the QMX's digital filter bandwidth).

ID: Get radio ID

Get: Always returns 020 (Kenwood TS-480)

IF: Get transceiver information (TS-480 format).

Get: Returns a composite information string containing the state of the transceiver, as follows (excluding command ID and ; terminator character):

- 11-digit operating frequency (VFO A or B, according to the VFO mode setting and transmit/receive state)
- 5 spaces
- 5-digit RIT frequency, as +/-9999Hz e.g. RIT up 200Hz returns "+0200" in this field
- RIT status: 0 = RIT OFF, 1 = RIT ON
- XIT status: always 0 because QMX has no XIT
- Memory channel bank number: always 0
- Memory channel number: always 00
- Transceiver status: 0 = RX, 1 = TX
- Operating mode: returns 1 for LSB, or 2 for USB (the normal mode for digi)
- Receive VFO: 0 = VFO A, 1 = VFO B
- Scan status: always 0
- Split: 0 = Simplex operation (VFO mode A or VFO mode B), 1 = Split
- Tone: always 0
- Tone number: always 0
- Space character

MD: Get/Set operating mode

Set: Set to 1 to set Lower Sideband (LSB) or any other value to set Upper Sideband (USB)

Get: Returns 2 (USB) if the mode is Upper Sideband (USB) which is the normal mode. Returns 1 if the mode is Lower Sideband (LSB).

Q0: Get/Set TCXO reference frequency

Set: Set TCXO reference frequency. Only values between 24999000 and 25001000 are allowed. The setting is for the current operating session only and is not written to EEPROM.

Get: Get TCXO reference frequency.

Q1: Get/Set Sideband

Set: Set sideband; 1 sets Lower Sideband (LSB), any other value sets Upper Sideband (USB). The setting is for the current operating session only and is not written to EEPROM.

Get: Get sideband; 0 = USB, 1 = LSB

Q2: Get/Set VFO A frequency – same as FA

Set: Set default operating frequency.

Get: Get default operating frequency.

Q3: Get/Set VOX Enable

Set: Set VOX enable: 1 enables VOX, 0 disables VOX. The setting is for the current operating session only and is not written to EEPROM.

Get: Get VOX enable; 1 = Enabled, 0 = Disabled

Q4: Get/Set TX Rise Threshold

Set: Set TX Rise Threshold, which should be a percentage number between 0 and 99 (see description elsewhere in this manual). The default setting of 80 is normally appropriate. The setting is for the current operating session only and is not written to EEPROM.

Get: Get TX Rise Threshold value

Q5: Get/Set TX Fall Threshold

Set: Set TX Fall Threshold, which should be a percentage number between 0 and 99 (see description elsewhere in this manual). The default setting of 60 is normally appropriate. The setting is for the current operating session only and is not written to EEPROM.

Get: Get TX Fall Threshold value

Q6: Get/Set Cycle Min parameter

Set: Set Cycle Min parameter (see description elsewhere in this manual). The setting is for the current operating session only and is not written to EEPROM.

Get: Get Cycle Min parameter value

Q7: Get/Set Sample Min parameter

Set: Set Sample Min parameter (see description elsewhere in this manual). The setting is for the current operating session only and is not written to EEPROM.

Get: Get Sample Min parameter value

Q8: Get/Set Discard parameter

Set: Set Discard parameter (see description elsewhere in this manual). The setting is for the current operating session only and is not written to EEPROM.

Get: Get Discard parameter value

Q9: Get/Set IQ Mode

Set: Set IQ Mode: 1 enables IQ Mode, 0 disables IQ Mode. In IQ Mode, the raw I & Q samples from the ADC are streamed directly to the USB Sound card. The setting is for the current operating session only and is not written to EEPROM.

Get: Get IQ Mode; 1 = Enabled, 0 = Disabled

QA: Get/Set Japanese Band Limits mode

Set: Set Japanese Band Limits mode: 1 enables Japanese band limits, 0 disables Japanese band limits. In Japanese Band Limits mode, QMX cannot transmit outside the allowed Japanese band limits. The setting is for the current operating session only and is not written to EEPROM.

Get: Get Japanese Band Limits mode; 1 = Enabled, 0 = Disabled

QB: Get/Set CAT timeout enable mode

Set: Set CAT timeout enable. 1 enables CAT timeout, 0 disables CAT timeout. When enabled, if in transmit mode, if there is no CAT command for a specified timeout, QMX automatically returns to receive mode.

Get: Get CAT timeout enable mode; 1 = Enabled, 0 = Disabled

QC: Get/Set CAT timeout

Set: Set CAT timeout. Specifies the CAT timeout in seconds.

Get: Get CAT timeout. Returns the CAT timeout in seconds

QJ: Get/Set TX shift threshold

Set: Set TX shift threshold (see explanation in Configuration screen description section of this manual)

Get: Get TX shift threshold

RD: Set negative RIT offset amount

Set: Sets negative (down) RIT; for example "RD-200;" sets the RIT to -200Hz

RT: Get RIT status

Get: Returns RIT status: 0 = RIT off, 1 = RIT on

RU: Set positive RIT offset amount

Set: Sets positive (up) RIT; for example "RD150;" sets the RIT to 150Hz

RX: Set the radio into Receive mode immediately

Set: Command RX; immediately puts the radio into receive mode. It is equivalent to TQ0;

SP: Get/Set Split mode

Set: Sets Split mode: 0 = OFF, 1 = ON. For example "SP1;" switches QMX to split mode

Get: Returns the Split state: 0 = OFF, 1 = ON.

TQ: Get/Set transmit state

Set: Sets transmit state: 0 = RX, 1 = TX. For example "TQ1;" switches QMX to transmit mode

Get: Returns the transmit state: 0 = RX, 1 = TX.

TX: Set the radio into Transmit mode immediately

Set: Command TX; immediately puts the radio into transmit mode. It is equivalent to TQ1;

VN: Returns firmware version

Get: Returns the firmware version. For example, VN; command returns VN1_05;

8.7.4 CAT monitor

The CAT command monitor is a very plain blank screen, whose only purpose is to scroll incoming CAT commands from the CAT host, and the QMX responses. You will only be able to use this screen if you have multiple serial ports connected – one (typically the main USB Virtual COM port) to the PC host and one to a terminal (or terminal emulator on a PC, via a USB-Serial converter), running the CAT monitor terminal application.

8.7.5 Log file

This application is very useful for debugging CAT problems. The log file is stored in the EEPROM chip. The EEPROM chip capacity is 128 KB (Kilobytes). However the configuration parameters also reside in EEPROM, so the available space for the log file is a little less. When the log file is full, no further characters are written to it.

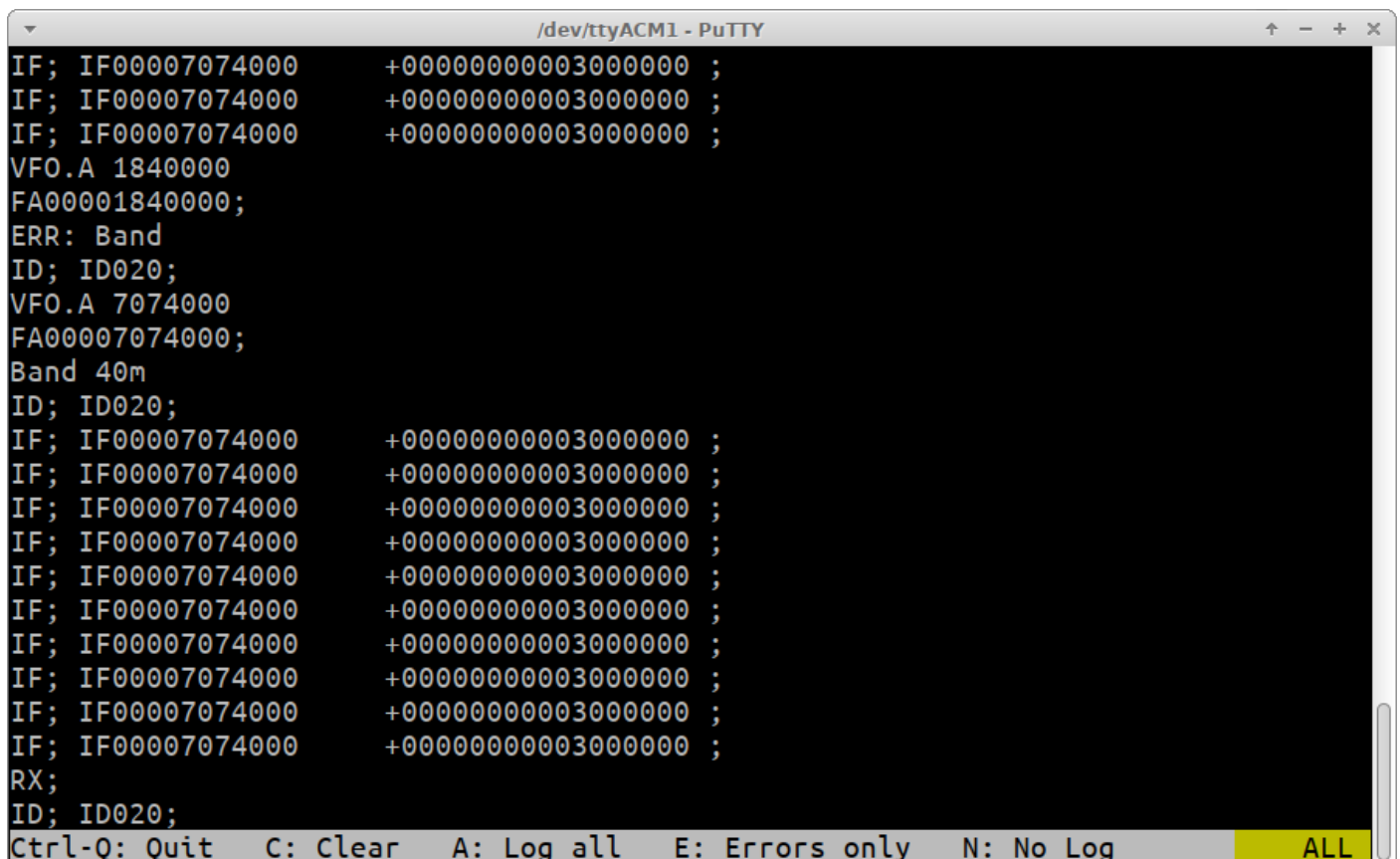

```

/dev/ttyACM1 - PuTTY
IF; IF00007074000      +000000000003000000 ;
IF; IF00007074000      +000000000003000000 ;
IF; IF00007074000      +000000000003000000 ;
VFO.A 1840000
FA00001840000;
ERR: Band
ID; ID020;
VFO.A 7074000
FA00007074000;
Band 40m
ID; ID020;
IF; IF00007074000      +000000000003000000 ;
IF; IF00007074000      +000000000003000000 ;
IF; IF00007074000      +000000000003000000 ;
IF; IF00007074000      +000000000003000000 ;
IF; IF00007074000      +000000000003000000 ;
IF; IF00007074000      +000000000003000000 ;
IF; IF00007074000      +000000000003000000 ;
IF; IF00007074000      +000000000003000000 ;
IF; IF00007074000      +000000000003000000 ;
IF; IF00007074000      +000000000003000000 ;
RX;
ID; ID020;
Ctrl-Q: Quit  C: Clear  A: Log all  E: Errors only  N: No Log  ALL
```

On opening the Log file application, the existing contents of the log file are displayed. When the screen is full, it will scroll automatically; you can use the scroll bar of the window to see text that has scrolled off the top of the screen if you wish. The current logging status is displayed in yellow in the bottom right corner. In this example, the status is “ALL” which means that all events are being logged.

The available keyboard commands are:

CTRL-Q: Quit the log file application screen (logging remains active, if enabled)
C: Clear the log file
A: Log all events
E: Log only error events
N: No logging at all (logging is switched off)

In the log file, each event is written as one line. There are several times of log file entry:

- Errors have the line prefix “ERR:”
- CAT commands are shown (semicolon terminated) followed by the command result, if any. An unrecognized or invalid CAT command would be prefixed by the error code “ERR: “.
- Radio state changes are indicated by the item being changed, followed by the new value.

Various examples from the screenshot above:

VFO.A 1840000 sets the VFO A frequency to 1.84 MHz
FA00001840000; CAT command from WSJT-X MHz
ERR: Band Error message “Band”

In this example, a CAT command was received from WSJT-X, to set the QMX to frequency 1.84 MHz. The CAT command is “FA00001840000;” - Note that the entries in the log file are not quite in chronological order, since the VFO update event is printed BEFORE the CAT command event; the reason for this is that the CAT evaluation must be completed in totality before the CAT command log event takes place, because only then do we know if the CAT command was successful. The final entry is an error message “Band” because 1.84 MHz is in the 160m band and this is not one of the bands currently supported by QMX.

VFO.A 7074000 sets the VFO A frequency to 7.074 MHz
FA00007074000; CAT command from WSJT-X MHz
Band 40m Sets the band to 40m

The operator then realizes his error setting QMX to 160m in the WSJT-X drop-down and chooses 40m instead; this time the CAT command successfully sets frequency and band.

IF; IF00007074000 +00000000003000000 ;

Here the “IF;” or Information request CAT command is received from WSJT-X and QMX replies with the CAT information string in the prescribed format.

For reasons known only to itself, WSJT-X likes to ask for the information screen multiple times in quick succession even though the result is the same.

The complete list of log events is as follows:

Event	Explanation	Example	Comment
Power up	Occurs every power up	Start 1_00_001	Shows the start event and version number
Set VFO	VFO frequency change	VFO.A 7074000	VFO A is set to 7.074 MHz. VFO B is also available
Band change	Band is set to a new value	Band 40m	An error is generated for bands not supported.
TX	Radio switched to Transmit	TX	Can be either by CAT command or by VOX
RX	Radio switched to Receive	RX	Can be either by CAT command or by VOX
VFO Mode	VFO mode set to A, B, or Split	VFO Mode A	An error is generated for any attempt other than A, B or Split
Split ON/OFF	CAT Split on/off command SP	Split ON	
Clk2	Signal generator frequency is set	Clk2 7075000	
Gain	Set audio gain	Gain 25	Audio gain is set by the AG; CAT command
RIT Down	RIT down CAT command	RIT DN 500	
RIT Up	RIT up CAT command	RIT UP 500	
CAT	Every CAT command	IF;	Every CAT command generates a log entry event

8.8 System menu

```
+---Main menu-----+
|+---System-----+
| |
| | System config
| | Log file
| | Update firmware
| |
|+-----+
+-----+
```

QMX v1_00_009 QRP Labs, 2023

The system menu contains:

- System config: the same system configuration parameters in the System config screen in the Configuration menu – refer to section 4.
- Log file: the same log file viewer tool described in the previous section
- Update firmware: puts the QMX into the QFU Bootloader mode, for firmware update. Please refer to the section of this manual describing the firmware update procedure.

8.9 Exit terminal

As mentioned previously, exit terminal returns QMX to normal operating mode, processing incoming CAT commands as usual. The terminal should also be disconnected (or closed) so as to free up the serial port for use by WSJT-X or whatever software you are using – remember that only one PC software application can use the serial port at a time.

9. Resources

- For updates and tips relating to this kit please visit the QRP Labs QMX kit page <http://qrp-labs.com/qmx>
- For any questions regarding the assembly and operation of this kit please join the QRP Labs group, see <http://groups.io/g/qrplabs>

10. Document Revision History

1_00_009	07-Aug-2023	First version, for firmware 1_00_009
1_00_010	30-Sep-2023	Added further example to WSPR callsign formatting requirements p34 Updates for firmware version 1_00_010
1_00_011	29-Nov-2023	Updates for firmware version 1_00_011