

## 10W HF Linear Power Amplifier kit assembly manual

A low-cost, high-performance HF Linear PA  
covering 2-30MHz

Designed and produced by QRP Labs, 2018

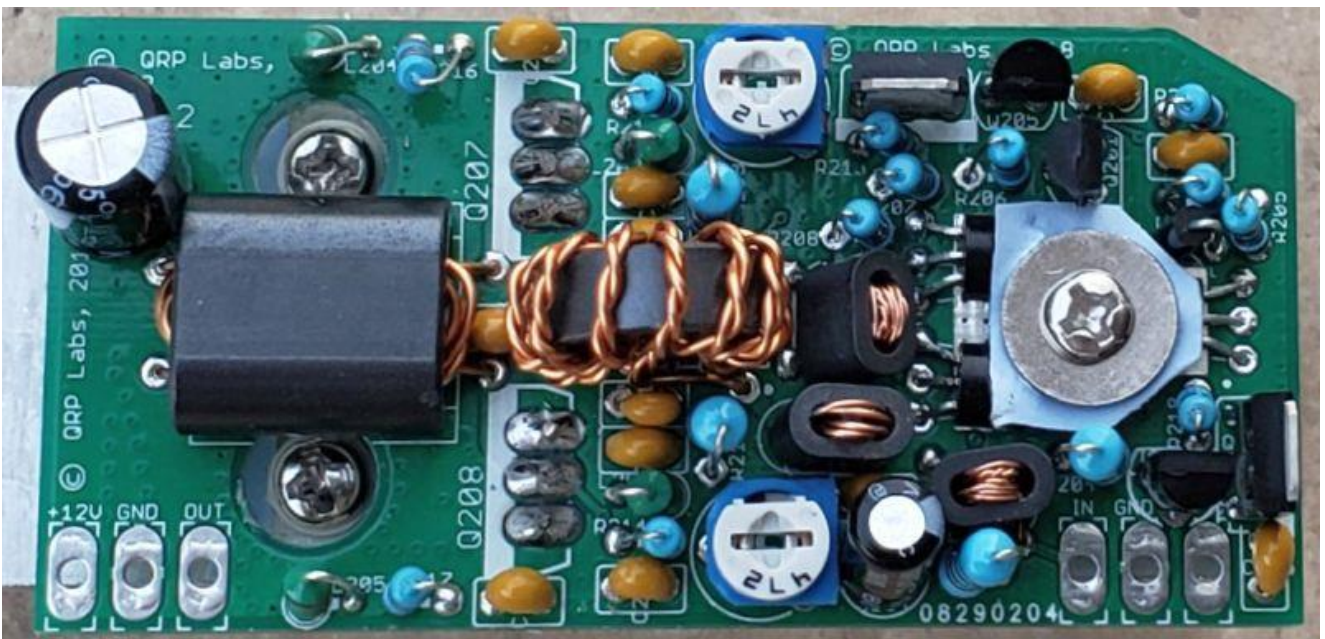
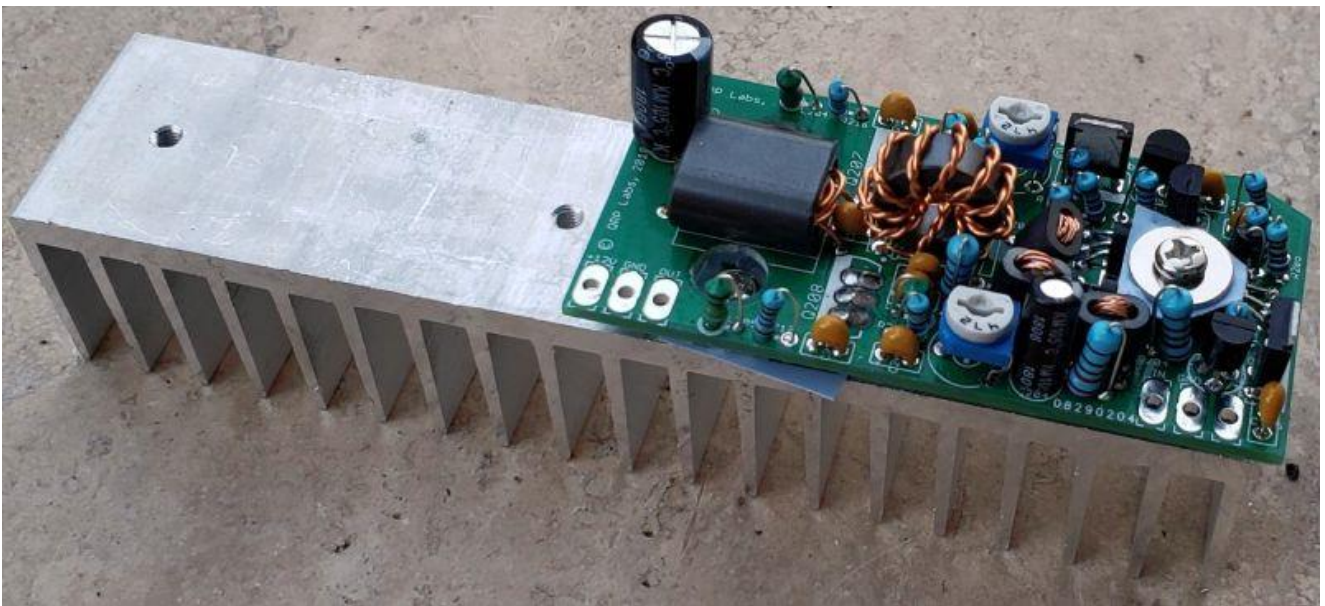

# Contents

1.	Introduction .....	3
2.	General Assembly guidelines .....	3
3	ASSEMBLY .....	4
3.1	Parts list.....	4
3.2	Trace diagram and parts layout .....	7
3.3	Schematic.....	9
3.4	Wind and install inductor L201 .....	10
3.5	Wind and install transformer T201 .....	11
3.6	Wind and install transformer T202 .....	13
3.7	Wind and install transformer T203 .....	14
3.8	install capacitor C213.....	16
3.9	Wind and install transformer T204 .....	16
3.10	Install capacitors C211 and C212 .....	18
3.11	Install remaining ceramic capacitors .....	18
3.12	Install inductors L202, L203, L204 and L205 .....	19
3.13	Install resistors R203, R204, R209, R210.....	19
3.14	Install resistors R201, R216 and R217 .....	20
3.15	Install resistors R207 and R208.....	20
3.16	Install resistors R213 and R218.....	21
3.17	Install resistors R212 and R214.....	21
3.18	Install resistor R202.....	22
3.19	Install resistor R205.....	22
3.20	Install resistor R206.....	23
3.21	Install trimmer resistors R211 and R215.....	23
3.22	Install capacitor C204.....	24
3.23	Install capacitor C214.....	24
3.24	Install diode D201 .....	25
3.25	Install transistor Q201.....	25
3.26	Install transistors Q202, Q203 and Q204.....	26
3.27	Install transistors Q206 and Q209 .....	26
3.28	Install transistor Q205.....	27
3.29	Install voltage regulator IC201 .....	27
3.30	Install transistors Q207 and Q208 .....	28
3.31	Install heatsink .....	30
4	Applications information .....	32
4.1	PA Precautions .....	32
4.2	Connections .....	32
4.3	Adjustment.....	33
4.4	Tests undertaken .....	33
5	Version History.....	35

# 1. Introduction

This 10W HF Linear Power Amplifier has the following features:

- 10W output from 2 to 30MHz, using 12V Supply
- Generously-sized heatsink, will not overheat even on continuous 100% duty-cycle modes
- 2-stage amplifier provides 26dB of gain
- Push-pull driver and push-pull finals, for high linearity and low harmonic content
- +/- 1dB gain flatness from 2 to 30MHz
- 4dB down at 6m (50MHz) and 8dB down on 4m (70MHz)
- Standard 50-ohm output
- Through-hole plated PCB, all through-hole components (no Surface Mount Devices)
- PCB size 69.69mm x 33.97mm (2.744 x 1.338 inches)
- Standard inexpensive components throughout
- Tested for 1 hour at full-power 10W, 100% continuous duty-cycle with no forced air cooling
- Tested for 15 minutes at 20W, 100% continuous duty-cycle with no forced air cooling
- Tested at 20V supply
- Tested into open load, shorted load and various mismatches

We hope you enjoy building and operating this kit! Please read this assembly manual carefully, and follow the instructions step by step in the recommended order.

The push-pull driver stage using two BS170's is as used in the SoftRock transmitter stage.

**I am very grateful to Allison KB1GMX for very valuable advice during the design and development of this amplifier, for beta-testing prototypes, measurements and moral support!**

## 2. General Assembly guidelines

Assembly of this kit is quite straightforward. But there are quite a lot of components. So please keep them methodically in trays or some convenient storage boxes. Be careful not to misplace any. The usual kit-building recommendations apply: work in a well-lit area, with peace and quiet to concentrate. **Some of the semiconductors in the kit are sensitive to static discharge.**

**Therefore, observe Electrostatic discharge (ESD) precautions. And FOLLOW THE INSTRUCTIONS!!** Don't try to be a hero and do it without instructions!

A jeweller's loupe is really useful for inspecting small components and soldered joints. You'll need a fine-tipped soldering iron too. It is good to get into the habit of inspecting every joint with the magnifying glass or jeweller's loupe (like this one I use), right after soldering. This way you can easily identify any dry joints or solder bridges before they become a problem later on when you are trying to test the project.

**Triple check every component value and location BEFORE soldering the component!** It is easy to put component leads into the wrong holes, so check, check and check again! It is difficult to de-solder and replace components, so it is much better to get them correctly installed the first time. In the event of a mistake, it is always best to detect and correct any errors as early





as possible (immediately after soldering the incorrect component). Again, a reminder: removing a component and re-installing it later is often very difficult!

Components in the kit are installed vertically, to minimize PCB area and track-lengths. You will need to bend the resistor wires as shown in the picture below. On the parts layout diagram, there is a small circle around the hole where the body end of the resistor should be installed. This is not critical (resistors don't care which way around they are) but it is recommended, just to try to ensure that the folded over wire-end of the resistor doesn't touch any other wire or metal part.

Please refer to the layout diagrams and PCB tracks diagrams and follow the steps carefully.

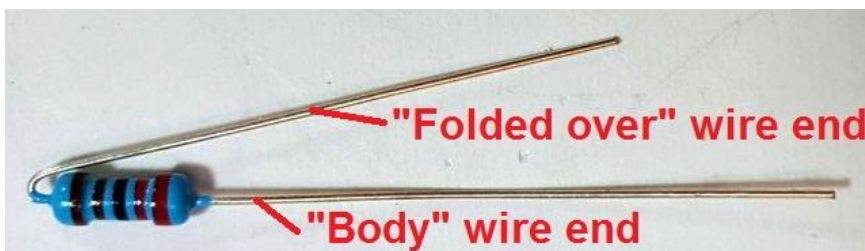

The component colour coding of the layout diagram at every step of the assembly instructions is as follows (kind of: components past, present and future):

- Components shaded grey have already been installed
- Components shaded red are the ones being installed in the current assembly step
- Components shaded white are the ones which have not yet been installed

**VERY IMPORTANT SOLDERING ADVICE:** when soldering a component pin that goes to ground, you need to allow extra time with the soldering iron. Ground pads are separated from the groundplane by what are called “thermals”, a gap between the pad and the groundplane which is bridged in 4 places at 0, 90, 180 and 270-degree around the circle. This is standard practice. However, you may STILL find that it is harder to solder ground connections, because the soldering iron heat is dissipated away more quickly. If a component ground connection is broken it can sometimes have catastrophic consequences. So please check and recheck, particularly with ground connections.

## 3 ASSEMBLY

The PA board is mounted vertically on the rear PCB's back edge. The PA transistor tabs and the driver are bolted directly to the substantial heatsink provided in the kit.

**Use a drill bit, twisted by hand, in each hole of the binocular cores, just to remove any sharp edges, and prevent scratching the wire enamel.**

**NOTE: The two BN61-2402 binocular cores are supplied in a small labelled bag. This is because they are visually identical to the BN43-2402 binocular core. Do not remove the BN61-2402 from their small bag, or you would risk mixing them with the BN43-2402.**

### 3.1 Parts list

This parts list shows the through-hole components to be inventoried and installed in the assembly.

#### Resistors

R201, 216, 217	220-ohm ¼W, red-red-black-black-brown (3pcs)
R203, 204, 209, 210	220-ohm ½W, red-red-black-black-brown (4pcs)
R202	22K, red-red-black-red-brown



R205	2.2K, red-red-black-brown-brown
R213, 218	10K, brown-black-black-red-brown (2pcs)
R212, 214	47-ohm, yellow-purple-black-gold-brown (2pcs)
R207, 208	2.2-ohm, red-red-black-silver-brown (2pcs)
R206	33-ohm, orange-orange-black-gold-brown
R211, 215	4.7K trimmer potentiometer, label "472" (2pcs)

### **Capacitors**

C201 - 203, 205 - 210, 215	0.1uF, code "104" (10pcs)
C204	10uF 25V electrolytic
C214	470uF 25V electrolytic
C211, C212	1uF, code "105" (2pcs)
C213	33pF, code "330"

### **Semiconductors**

D201	1N4004
Q201	2N3904
Q202, 203, 204, 205	BS170 (4pcs)
Q206, 209	IRFU9024, substitute for BS250 (2pcs)
Q207, 208	IRF510 (2pcs)
IC201	78L05, 5V voltage regulator

### **Inductors**

L201	BN43-2402 binocular core
L202, L203, L204, L205	1uH molded axial inductors
T201, 202	BN61-2402 binocular core (2pcs, separate bag)
T203	FT50-43 toroidal core
T204	BN43-202 binocular core

### **Miscellaneous**

PCB	PCB
0.6mm wire	80cm of 0.6mm enamelled wire
0.4mm wire	15cm of 0.4mm enamelled wire
0.25mm wire	60cm of 0.25mm enamelled wire
Insulating silicone pad	Insulating heatsink silicone pad (3pcs)
M6 nut	M6 nut
Washer	Large washer
Insulating washer	2pcs white plastic insulating washer
9mm M3 bolt	9mm M3 bolt
15mm M3 bolt	15mm M3 bolt
Rubber tube	Short ~4mm length of rubber tube
Heatsink	Custom-manufactured 130x28x25mm

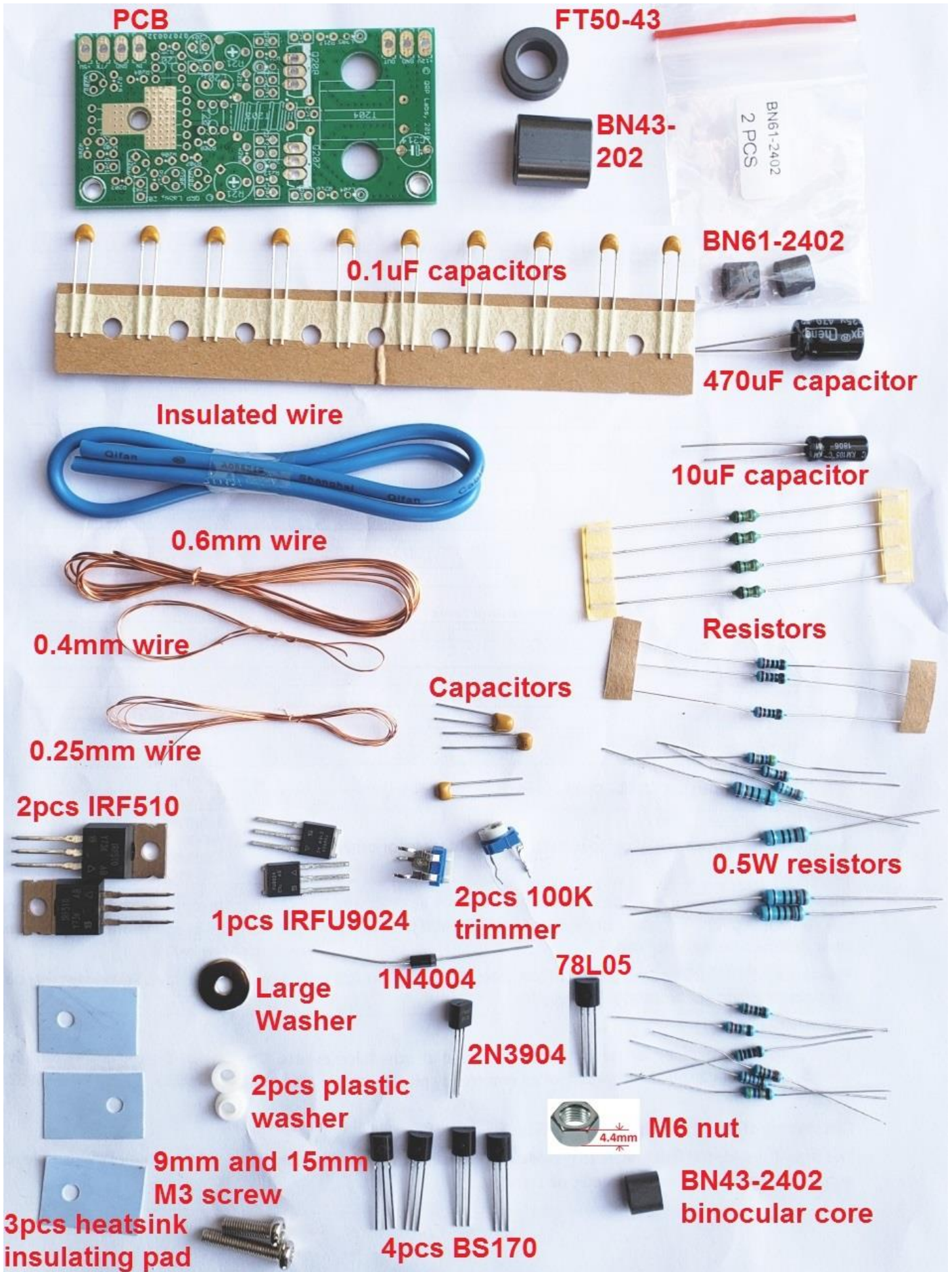



## 3.2 Trace diagram and parts layout

Red = Top side; Blue = bottom side; Green = pads and vias.

There are only two layers (nothing is hidden in the middle). Not shown in these diagrams are the extensive ground-planes, on both sides of the board. Practically everything on both layers that isn't a RED or BLUE track, is ground-plane! The two ground-planes are connected at frequent intervals (not more than 0.1-inches) by vias.

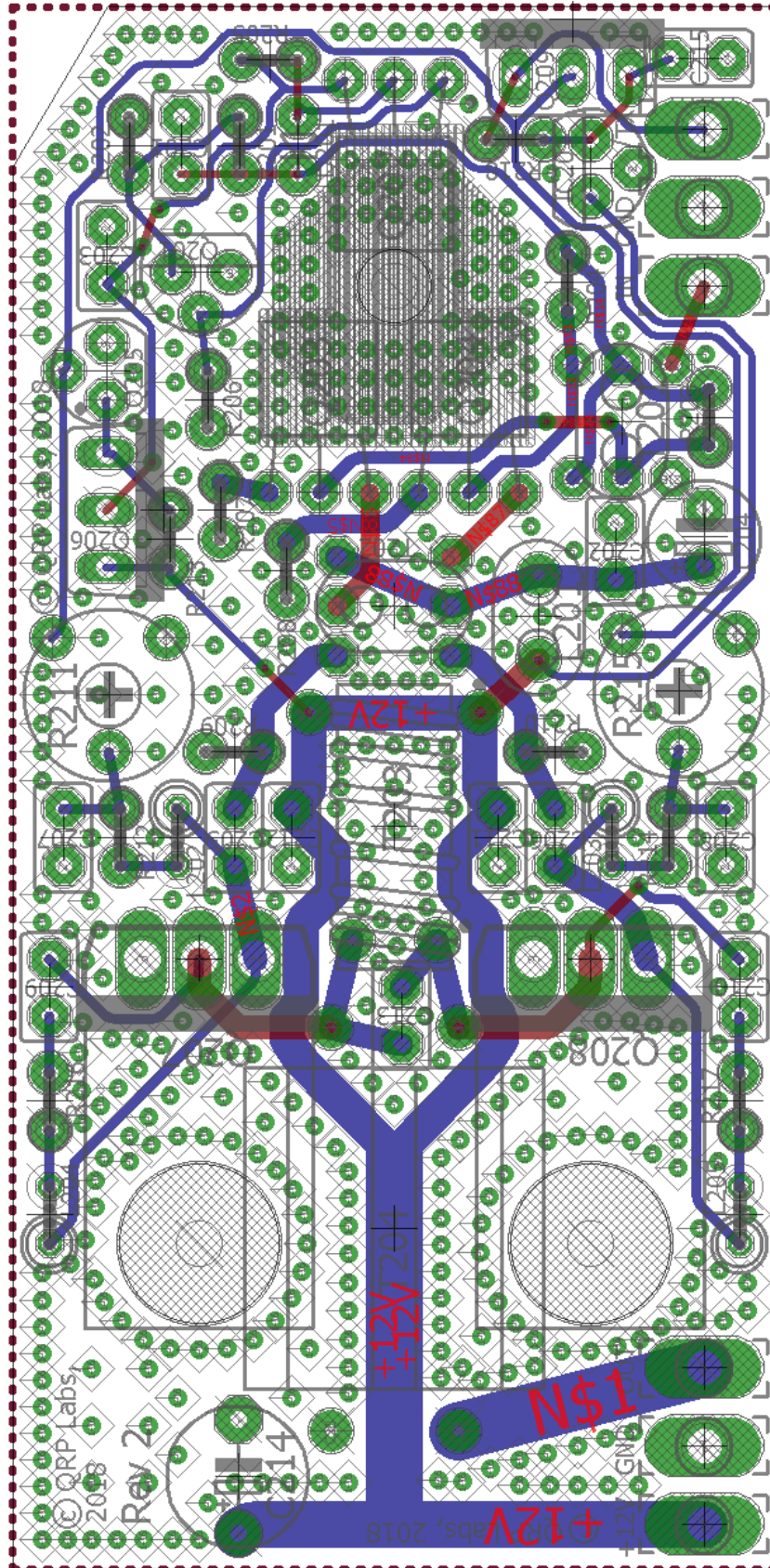

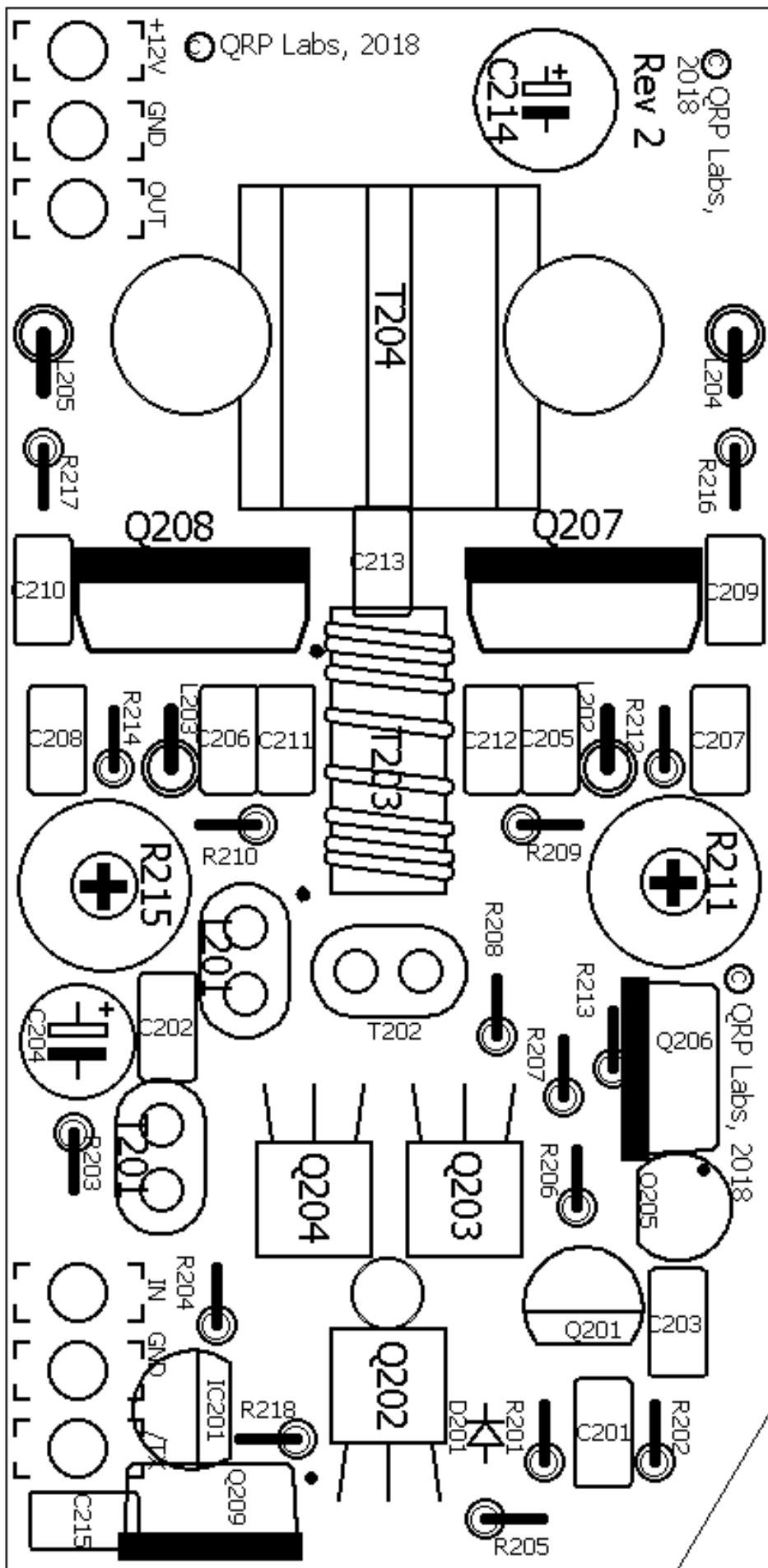



### 3.3 Schematic

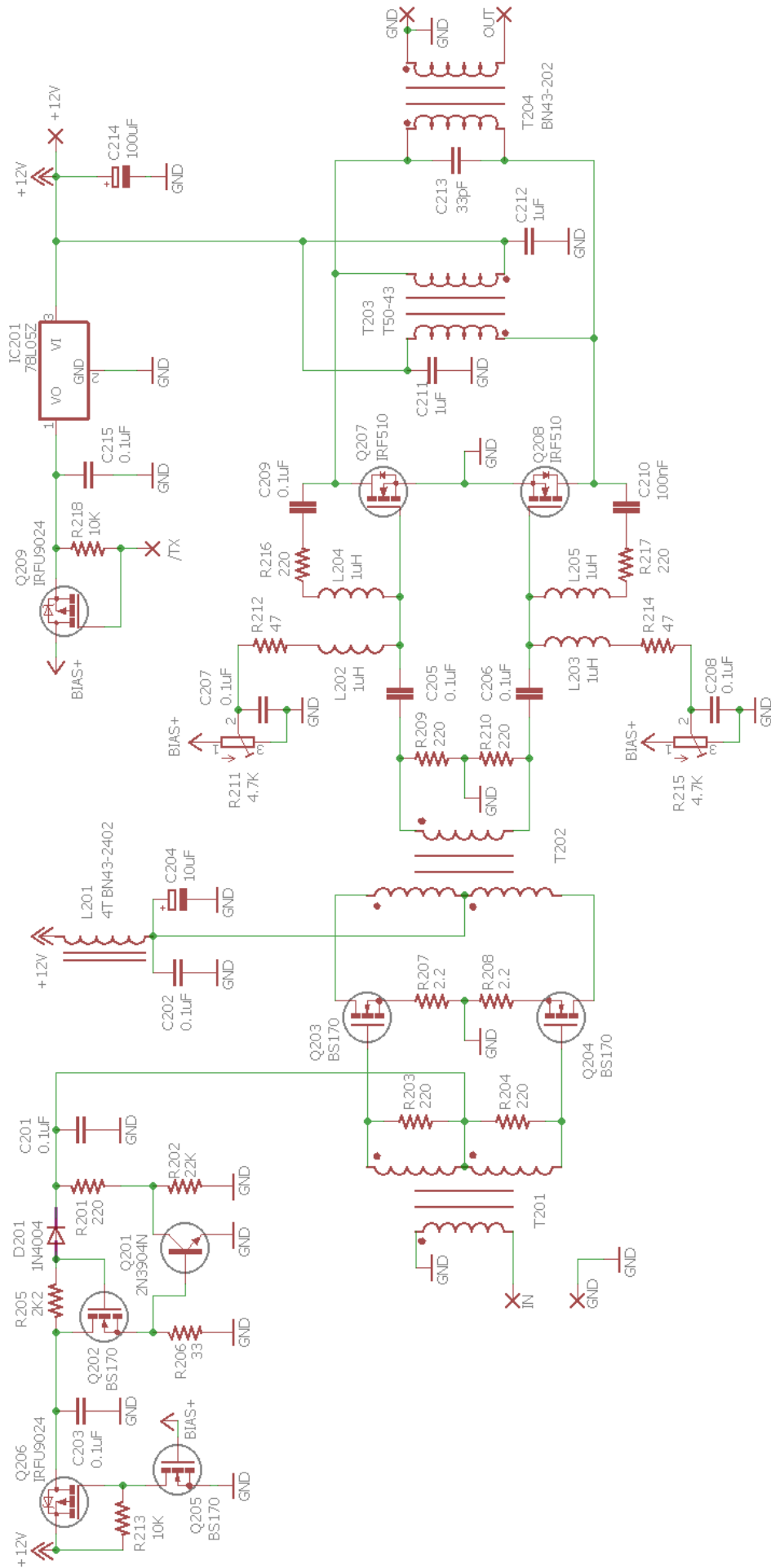

### 3.4 Wind and install inductor L201

Start with the inductors and transformers because they are difficult to install when the other components are all around them.

**The BN43-202 core is the one NOT in the small plastic zip-lock bag.** First use a drill bit twisted **by hand**, to gently remove any rough edges to the holes, that could cut into the wire.

L201 is a simple inductor made of 4 turns of the 0.4mm (Medium thickness) wire wound around the BN43-2402 binocular core. “One turn” means the wire goes through **both** holes. The start and end wires of the toroid wire therefore are both on the same side.

Install it on the PCB, cut the wires to 2mm and as usual, solder it for at least 10 seconds to ensure the enamel burns off.

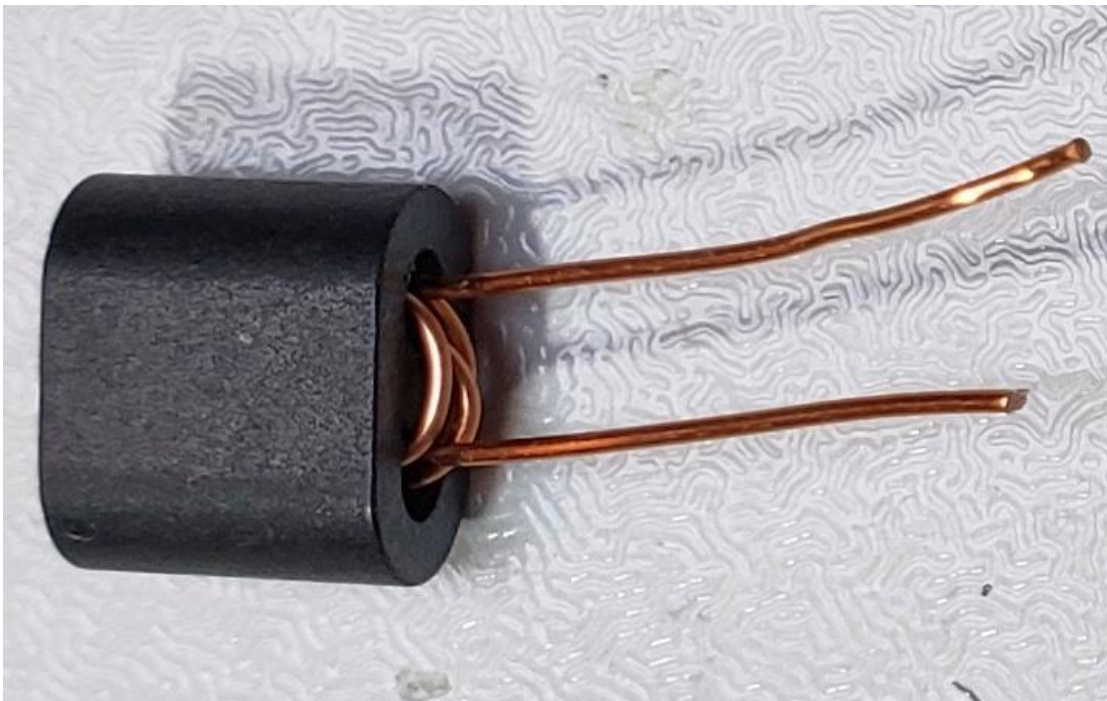

Test for DC continuity between the 12V pad of the PCB (indicated in the black circle) and the positive pad of capacitor C204 (indicated in the red circle).

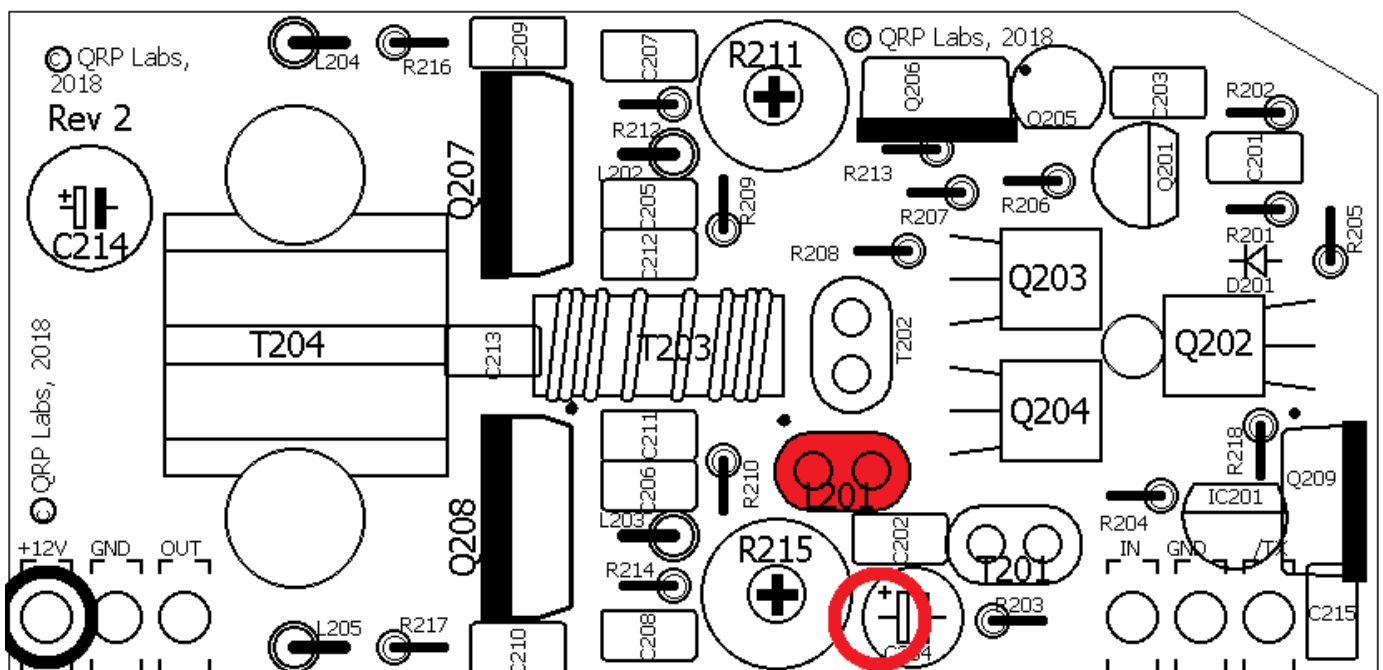

### 3.5 Wind and install transformer T201

T201 is wound on a BN61-2402 binocular core (two of these are in the small internal zipped bag). Again, use a drill bit, twisted by hand in each end of each of the binocular core holes, to remove any rough edges which could cut into the wire enamel.

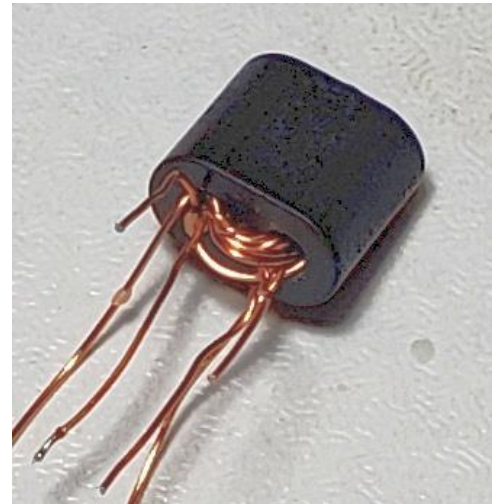

T201 has a primary consisting of 6 turns, and the secondaries are made up of 3 bifilar turns. First use a drill bit twisted by hand, to gently remove any rough edges to the holes, that could cut into the wire.

Un-wind the thinnest wire. The best way to un-wind it, without tangling it up, is to think of what the kit-packing person that wound it up did. Then reverse his steps. So, first unwind the tightly wrapped part in the middle where the end of the wire has been secured. Then, open out the spool of wire so that it is a circle. Then unwind the spool, around your fingers, reversing the process of the person winding it in the first place. Straighten the wire carefully and make sure there are no kinks.

Cut the thinnest wire into 4 equal pieces. Take ONE of those pieces, bend it in the middle (do not cut it yet), and twist it into bifilar-style wire. There are many ways to do this. You could clamp one end and twist the other in a VERY LOW-speed drill or using an electric screwdriver. Or just apply twists by hand, this is the method I use.

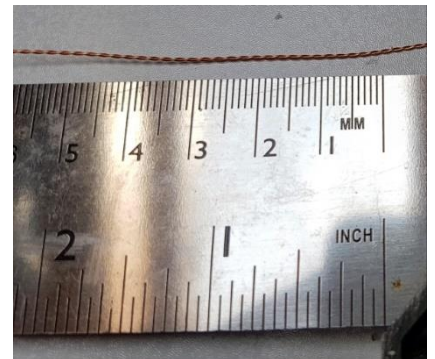

The number of twists is not critical, and it will not be the end of the world if it does not look perfectly neat.

Wind 3 turns of this bifilar wire on the core, remember that one “turn” goes through BOTH holes, so in the end all the wires come out on the same side of the toroid.

Now take ONE more of the pieces of thinnest wire, and wind it through 6 turns. Remember, one turn means the wire goes through BOTH holes of the toroid.

It is difficult to get the 6 turns through. It takes a great deal of patience. It can help to use a wooden toothpick to poke in the holes, to move the existing wires to one side, to make space for you to push through the new wire. Do not use anything metallic for this (such as a screwdriver) which would scratch the enamel of the wire.

**Be assured that it IS possible, I have wound many of these to prove it!**

At the end of it, you have a transformer like the picture, with 6 wires coming out of it. Two pairs of wires will be the bifilar windings. Untwist these ends but don't remove the kinks from the wire. This is how you can identify the primary winding: since it was never twisted into bifilar wire.

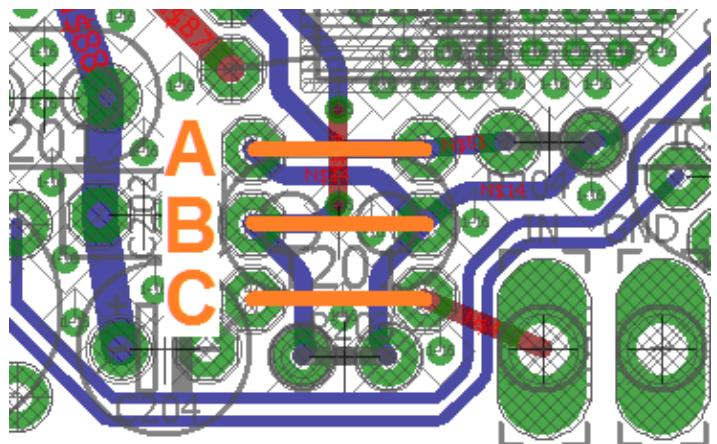

Now it is necessary to identify the wires of the bifilar winding. So, tin the ends (by scraping enamel off, or holding the wire ends in a blob of molten solder for 10 seconds). Use a DVM





to identify which pairs of wires have DC continuity.

Now if windings A and B refer to the identified as the bifilar windings, and C is the primary winding, install the wires in the PCB as per the diagram. Note that the orientation of the core matches the silkscreen print on the PCB.

Make sure that C is the primary winding – you can ensure this because it is only wire on each side which is not tightly twisted bifilar wire. A and B are bifilar; C is the single wire.

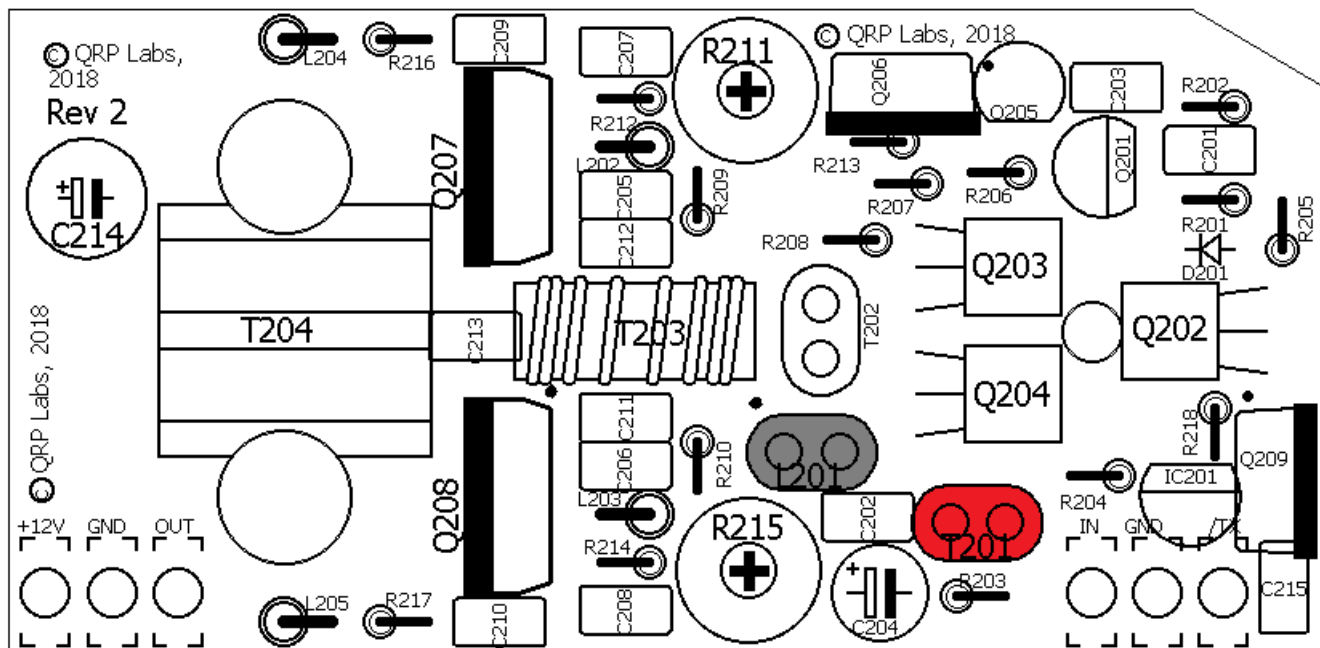

Now test the DC continuity again between all three sets of wires (A, B, C) BEFORE soldering, to make sure that there are no mistakes.

Also make sure that there is NO continuity between A, B and C wires, which would indicate a short-circuit somewhere in the wiring, perhaps caused by a break in the enamel insulation.

When completely happy, cut the wires to 2mm below the PCB and solder them, allowing 10 seconds of heat to burn way the enamel. Inspect the joints with a jeweller's loupe or magnifying glass.

Finally do a continuity test, testing for continuity between the "IN" and "GND" pads of the PA PCB, holding the black and red probes as indicated by the black and red circles respectively, in this diagram.

If there is no continuity, it indicates a problem with the soldering of the primary winding which we called "C".

Next test for continuity across the pads of R203, which is winding "B", and DC continuity across the pads of R204, which is winding "A". If either of these tests reveals no DC continuity, then go back and check the soldering of the appropriate T201 transformer winding.

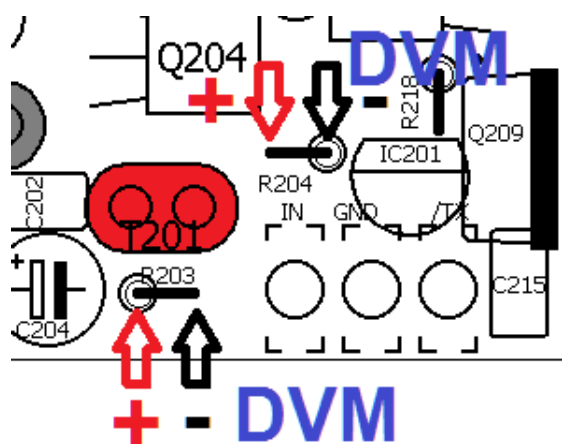
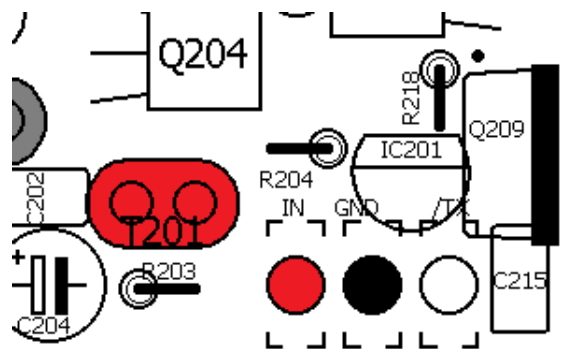

### 3.6 Wind and install transformer T202

T202 is wound on a BN61-2402 binocular core. It has a primary consisting of 3 bifilar turns, and a secondary of a single 5-turn winding. First use a drill bit twisted by hand, to gently remove any rough edges to the holes, that could cut into the wire.

Whilst the electrical definition of “primary” and “secondary” has swapped relative to T201 in the previous section, the physical construction of the T202 transformer is very similar to T201. The only difference is that the single-wire winding is 5 turns this time. Therefore, simply repeat the procedure for winding the coil in the previous section, using 5 turns for the single-wire winding.

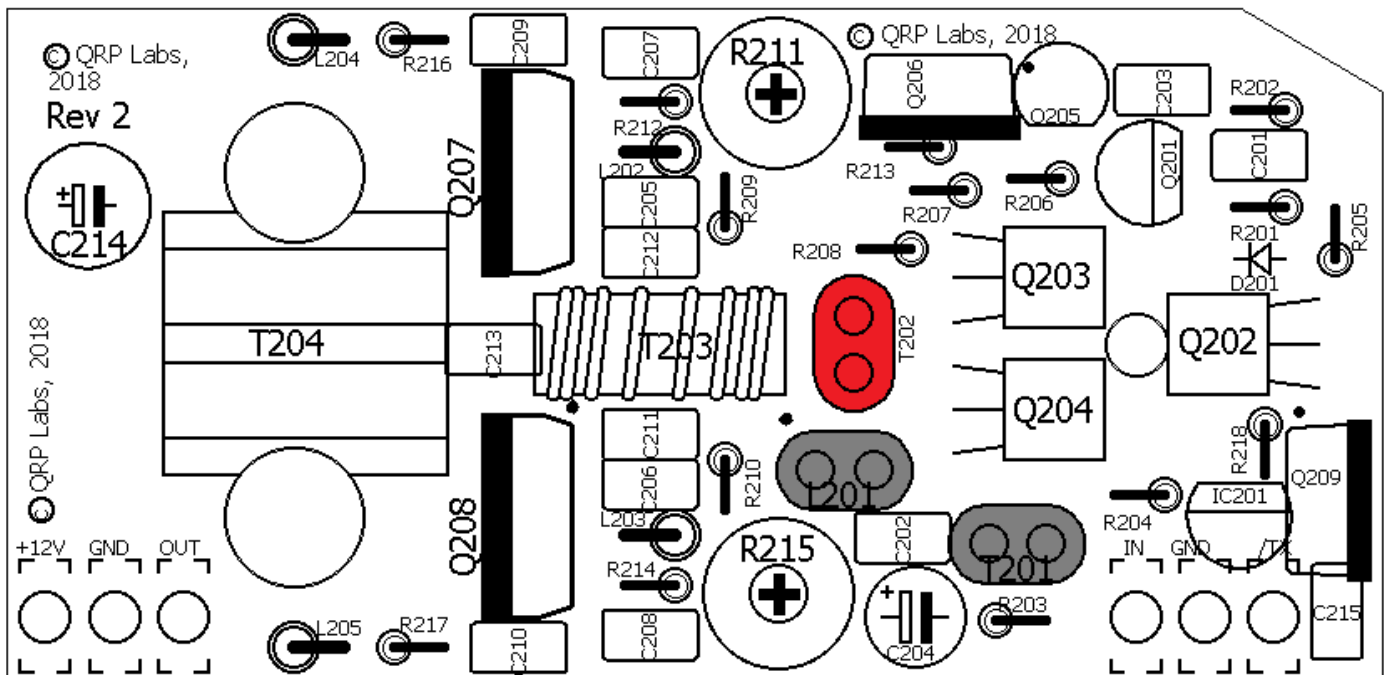

Similar to the previous section, let us identify the bifilar windings as A and B, and the single-wire winding as C. Again, untwist the bifilar winding ends and identify the pairs of wires with the DC continuity test. Be sure to keep the C winding (single-wire) separate and don't confuse it with the other two windings.

Installation on the PCB in the T202 position is very similar to T201, but rotated through 90-degrees. Again, match the shape of the binocular core to the drawing on the PCB silkscreen.

Again, test the windings A, B and C for continuity of the wire ends, through the right pairs of holes A, B and C, BEFORE soldering. Only when you are sure that all 6 wires are in their correct holes, proceed with cutting them to 2mm protrusion and soldering them. Again solder the wires for 10 seconds or more until the enamel has burned off and a good joint is made. With these thin wires the burning method is quite easy.

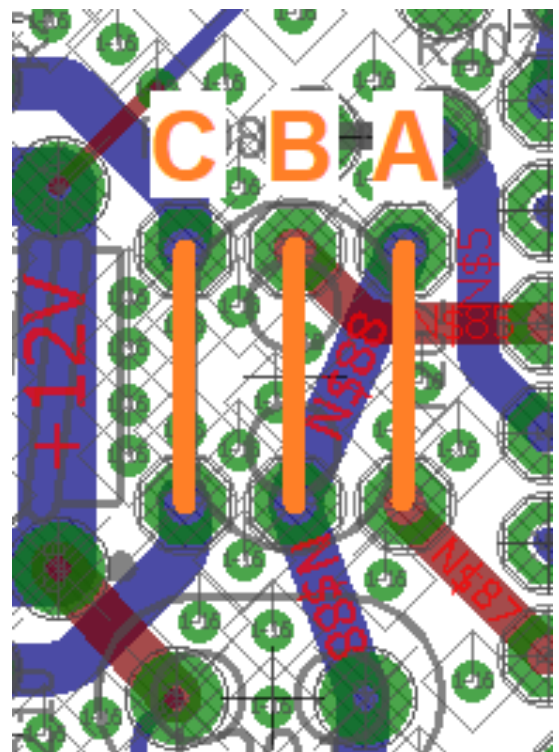

Now undertake the usual continuity test.

To test the "C" single-wire winding, connect the DVM probes to the top pad of R210 and the bottom pad of R209. If you do not see DC continuity, go back and check the C winding soldering joints.

To test the "B" bifilar winding, connect the DVM probes to the left side pad of C204 and the indicated pad of the Q203 transistor. If you do not see DC continuity, go back and check the B winding soldering joints.

To test the "A" bifilar winding, connect the DVM probes to the left side pad of C204 and the indicated pad of the Q204 transistor. If you do not see DC continuity, go back and check the A winding soldering joints.

Again, it is wise to check for any shorts between the C winding and the A/B windings. You should not see a DC zero resistance (continuity) between any A/B to C test points. On the other hand, A and B test points will show DC continuity between each other since the windings are connected in the circuit.

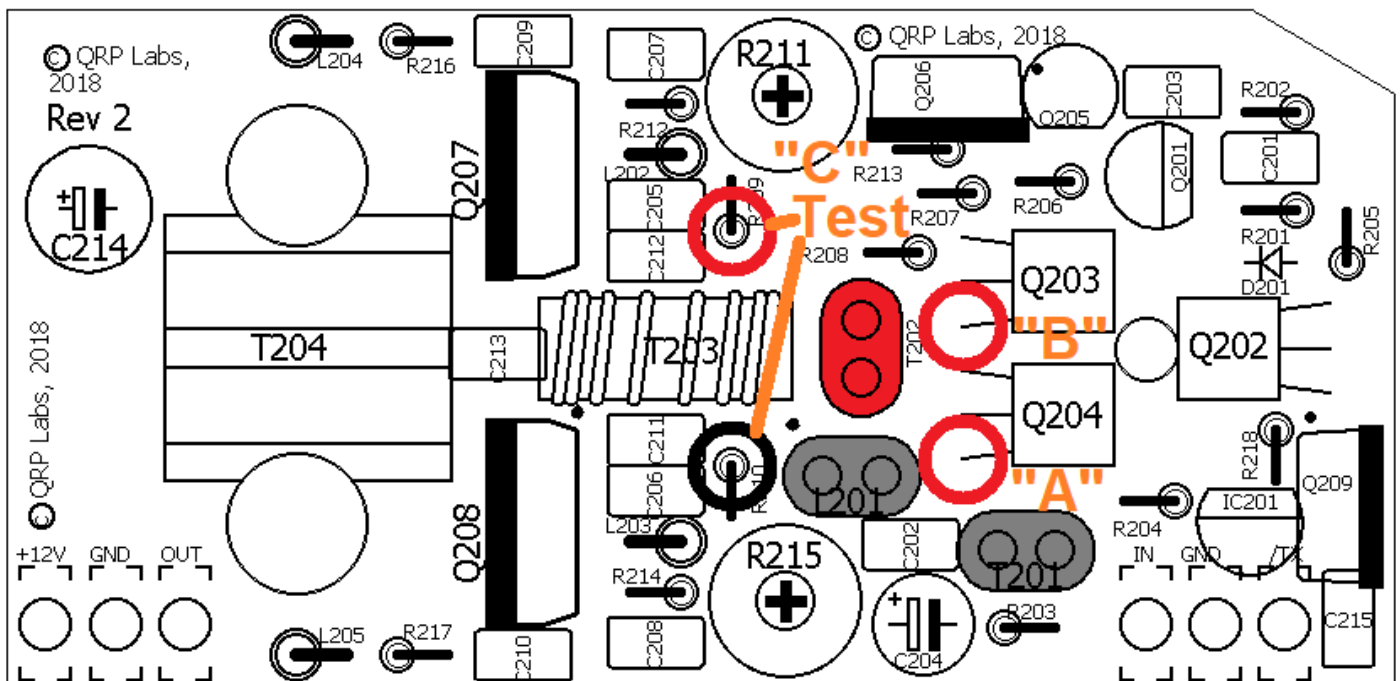

### 3.7 Wind and install transformer T203

T203 is wound on a FT50-43 toroidal core. It consists of 10 turns of bifilar twisted 0.6mm wire.

10 turns of wire on a 0.5-inch size toroid will require 22cm of bifilar-wound wire. You should therefore start by cutting say, 50cm of the 0.6mm wire. Prepare it by twisting it tightly together the same as previous bifilar wires. Wind 10 turns (10 times through the hole in the toroid).

Untwist the ends, and tin the wire ends. This thicker wire does not so easily burn off the enamel by the solder blob method. So, I find it helpful to scrape the wire ends a little using a wire-cutter, THEN tin them with solder for 10 seconds.

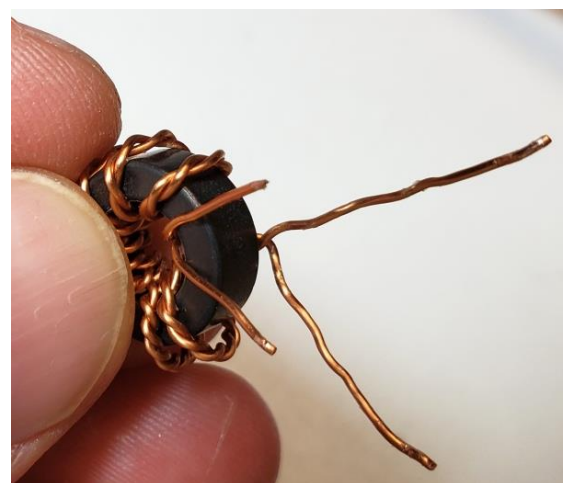

Identify the pairs of windings. This could be confusing: now the windings CROSS when they are inserted into the PCB holes.



Put another way: notice that the outline of the toroid goes horizontally across the PCB. One pair of twisted wires comes out on the upper side, the other pair of twisted wires comes out on the lower side. The upper two twisted wires are put into the upper two holes; the lower two twisted wires are put into the lower two holes. But there is an extra wire swap such that the electrical connectivity is as shown by the orange lines in the diagram.

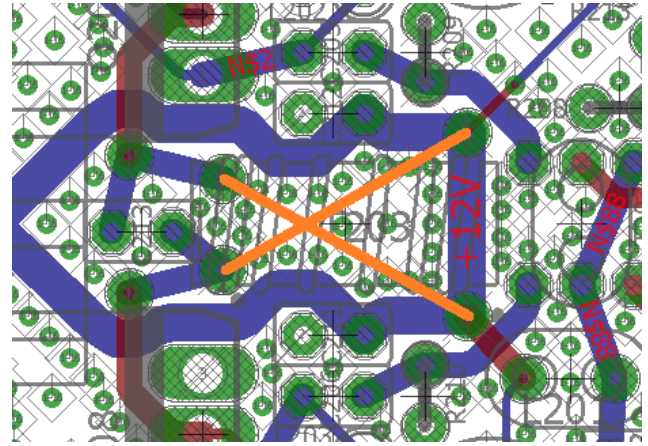

Before cutting or soldering the wires, check again very carefully, with a DVM touched to the wire ends, that you have continuity between the two pairs of points, as indicated by the orange lines. Only when you are totally sure the four wires are in their correct holes, cut them to 2mm protrusion, scrape them a bit with the wire cutter, then solder them (for at least 10 seconds).

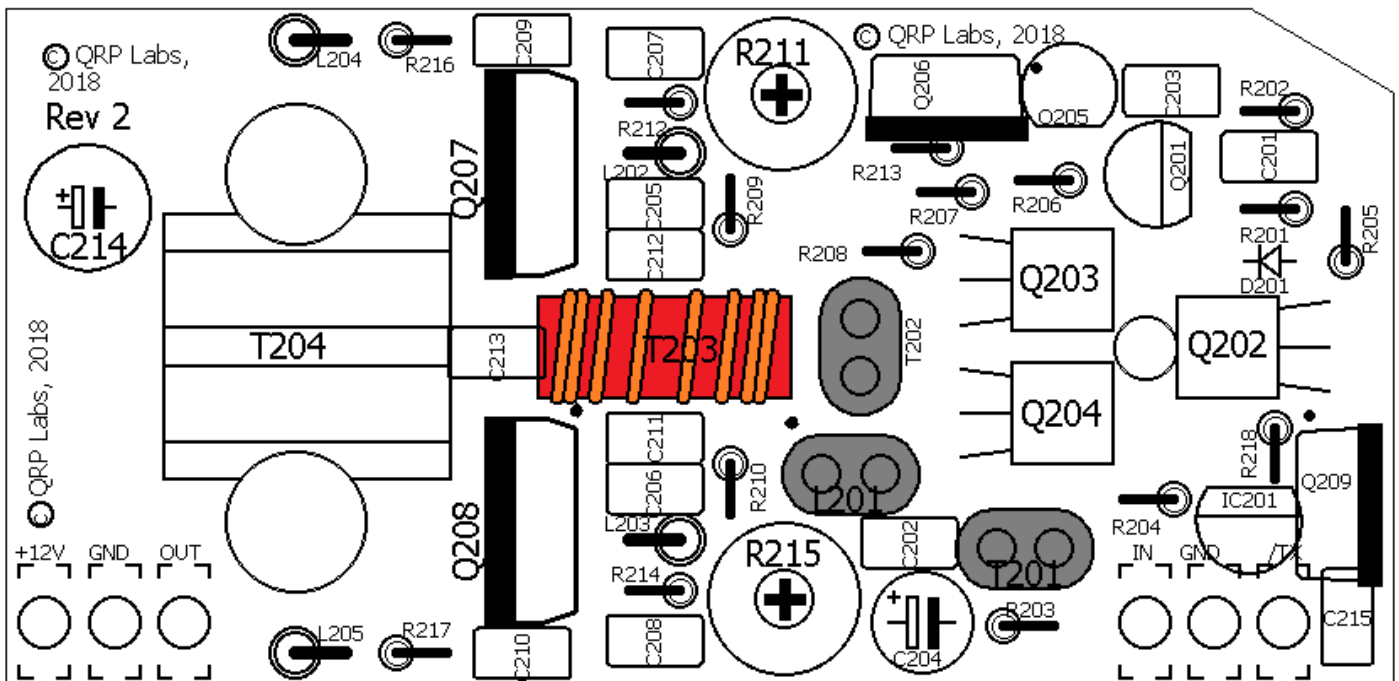

For a continuity test to make sure that the four wires have been properly soldered, simply connect the DVM across the pads for C213.

If there is DC continuity this verifies that all four wires are correctly soldered to their pads.

It does NOT verify that the 4 wires are in the correct 4 holes – you will have had to correctly identify the wires as described.

If there is no DC continuity then go back and check the soldering of the 4 wires (and check that the enamel was properly scraped/burnt off).

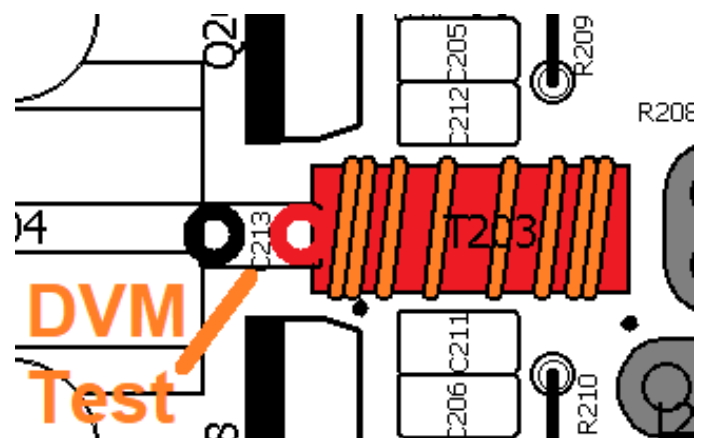

### 3.8 install capacitor C213

Although we intended to install the transformers and inductors first, you can see that C213 is stuck tightly between T203 and T204, and it will be easier to install it now rather than later. This is a 33pF capacitor with code “330”.

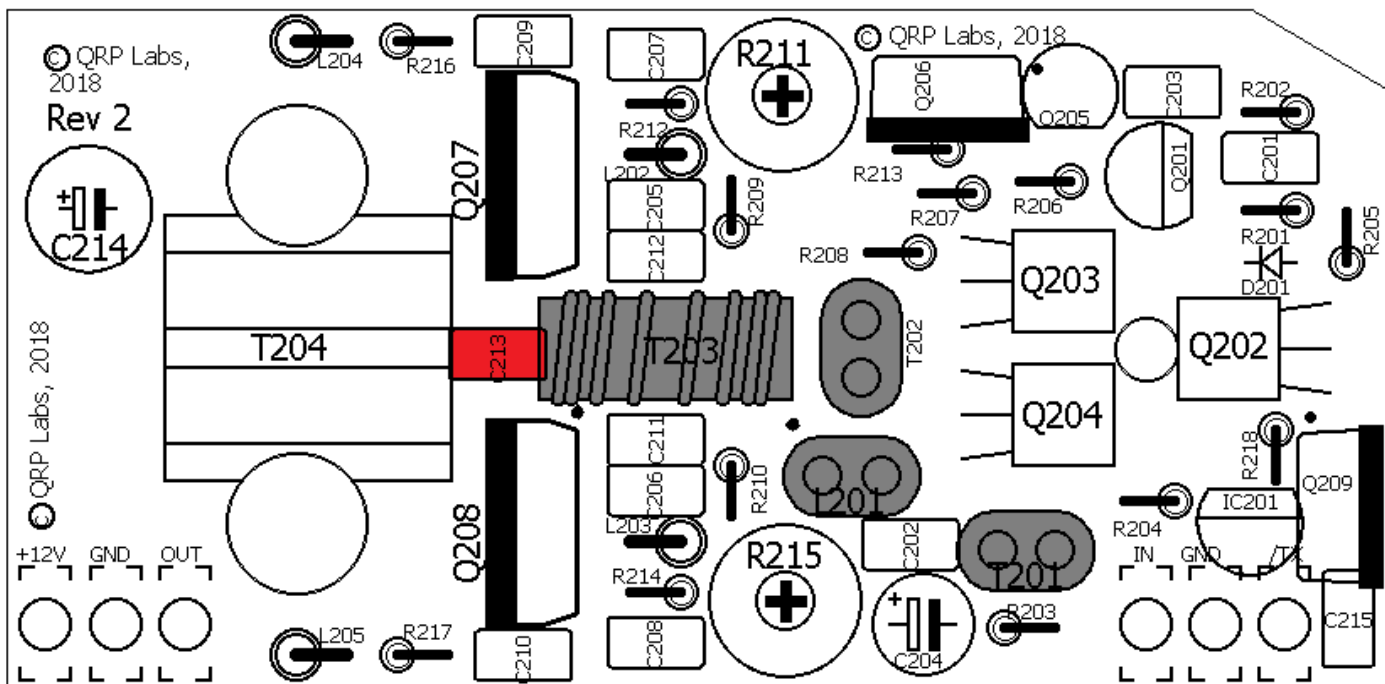

### 3.9 Wind and install transformer T204

T204 is wound on a BN43-202 binocular core, with a turns ratio of 2:3 using the remaining 0.6mm (thick) wire. A 2-turn primary and 3-turn secondary. This transformer is relatively easy to wind.

First use a drill bit twisted by hand, to gently remove any rough edges to the holes, that could cut into the wire.

Hold the binocular core orientated the same as the layout diagram, i.e. with the hole axes horizontal.

Start the 2-turn winding on the RIGHT-hand side end of the binocular holes. Remember that each “1 turn” means the wire passes through both holes of the binocular core. So, push the wire through to the left end, and then back through the other hole to the right; then the same again for the second turn. The ends of the 2-turn winding therefore both come out on the right-hand side.

Now do the same for the 3-turn winding, this time starting from the left-hand side (with the binocular core being held in the orientation of the PCB layout diagram). The ends of the 3-turn winding will come out on the left-hand side of the BN43-202 binocular core.

The only RISK is that you drop the core or somehow mix it up, so that you forget which end of the binocular core has the 2-turn and which has the 3-turn.

**Be very careful to keep a tight grip on this binocular core transformer and remember its orientation. The amplifier won't work well if the 2-turn and 3-turn windings are mixed up.**

Insert the two right-hand winding ends (2-turns) in the corresponding two holes in the PCB which are on either side of capacitor C213.

Insert the two left-hand winding ends (3-turns) in their corresponding two holes also.

Pull the wires tight on the underside of the board. Cut the protrusions to 2mm, and scrape the wire with wire-cutters. This thick wire doesn't easily allow the soldering iron heat to burn off the enamel, so scraping the enamel off first helps. The thick wire also absorbs heat easily so be sure to hold the soldering iron on the joint for at least 10 seconds to be sure of a good connection.

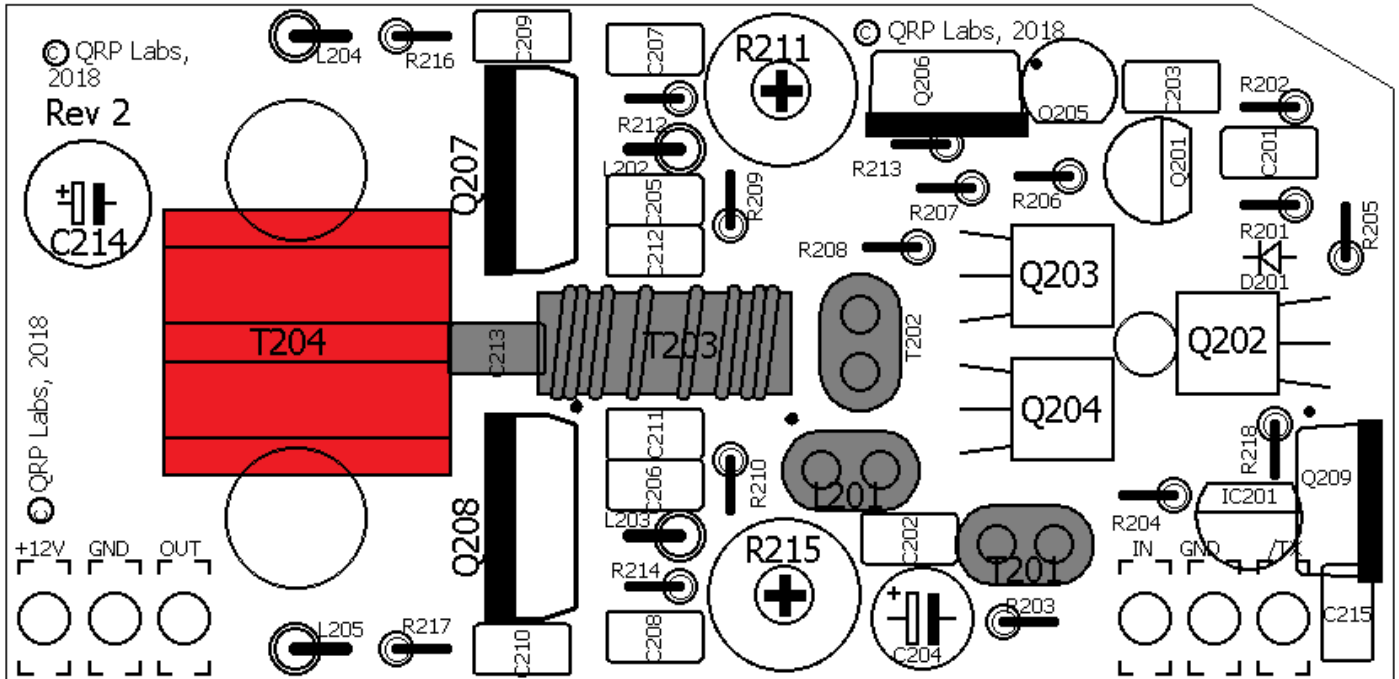

The 3-turn “output” winding can be checked for DC continuity by looking for zero ohms resistance between the “GND” and “OUT” hole pads at the bottom left corner of the PCB.

There is no way to check the continuity of the 2-turn “input” winding of T204 because there is already DC continuity through the windings of T203. So careful soldering and an inspection with a jeweller’s loupe or magnifying glass are the only options available.



### 3.10 Install capacitors C211 and C212

These two capacitors are 1uF ceramic capacitors with label "105".

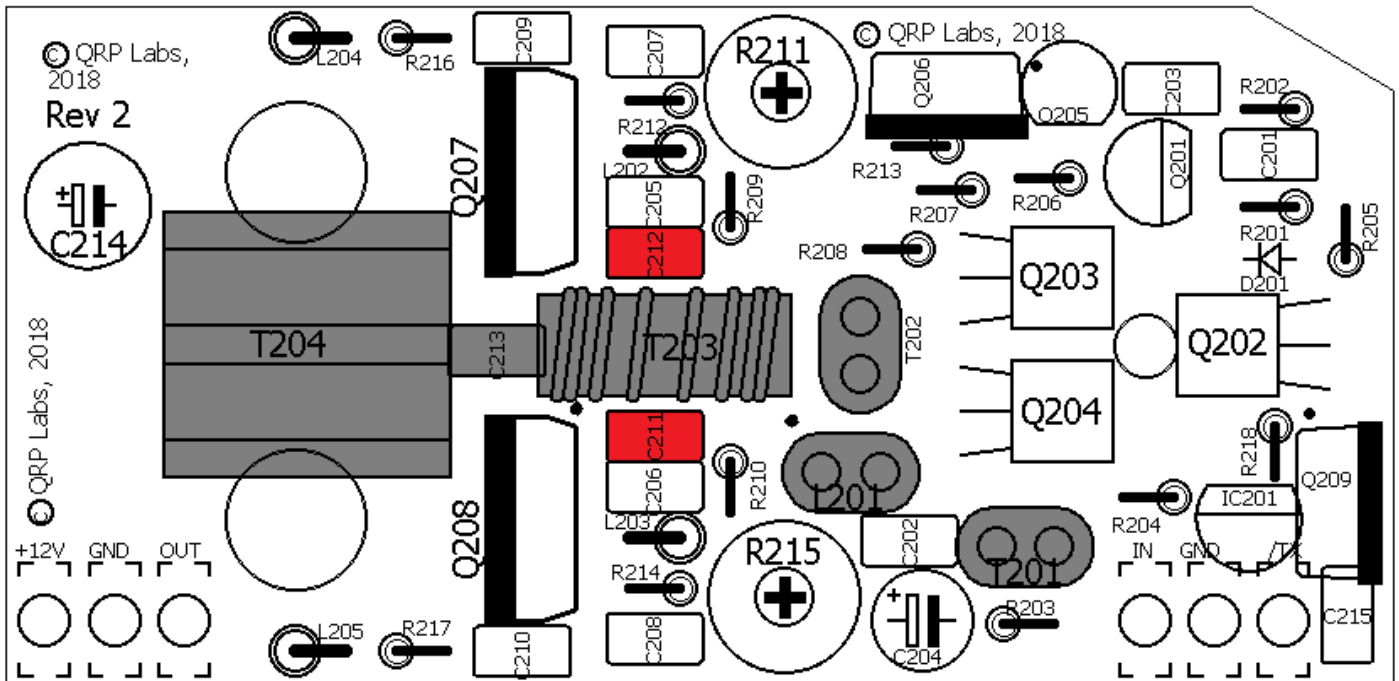

### 3.11 Install remaining ceramic capacitors

The remaining 10 ceramic capacitors are all 0.1uF ceramic capacitors with label "104".

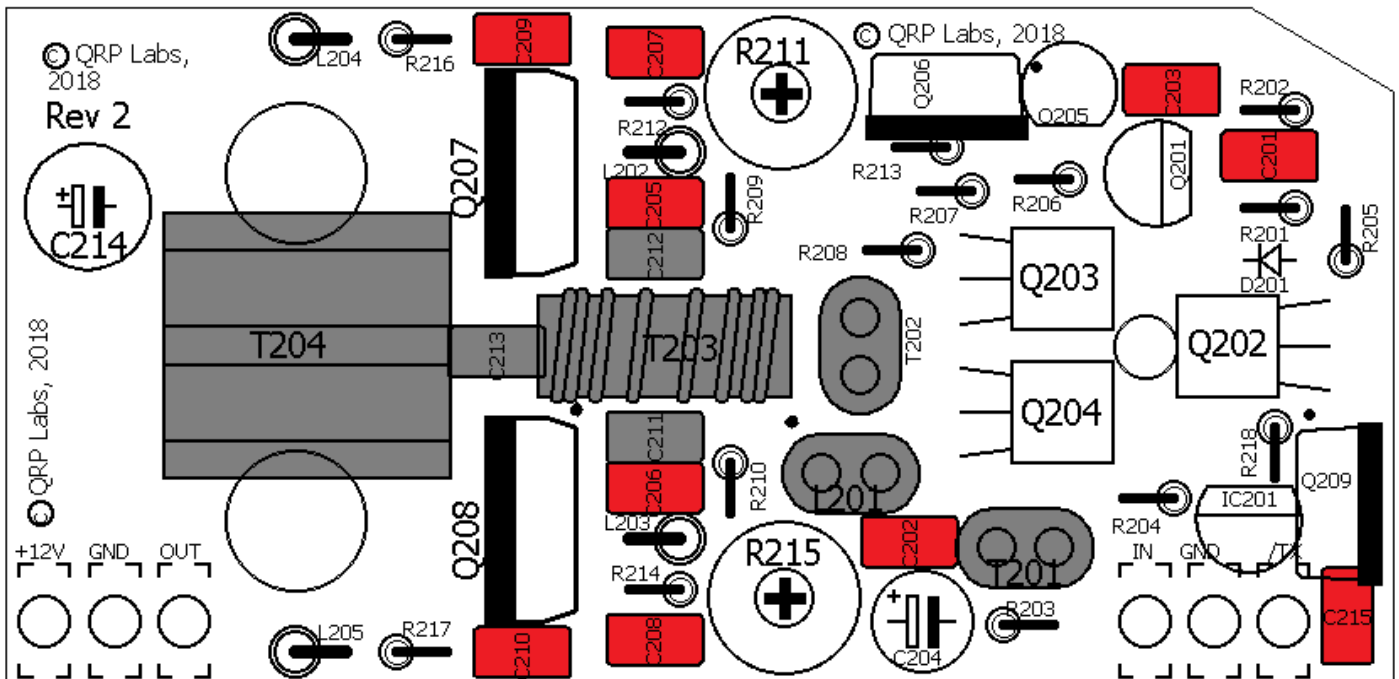

### 3.12 Install inductors L202, L203, L204 and L205

These are 1uH axial molded inductors. One lead is to be bent over so that they are mounted vertically, like the resistors.

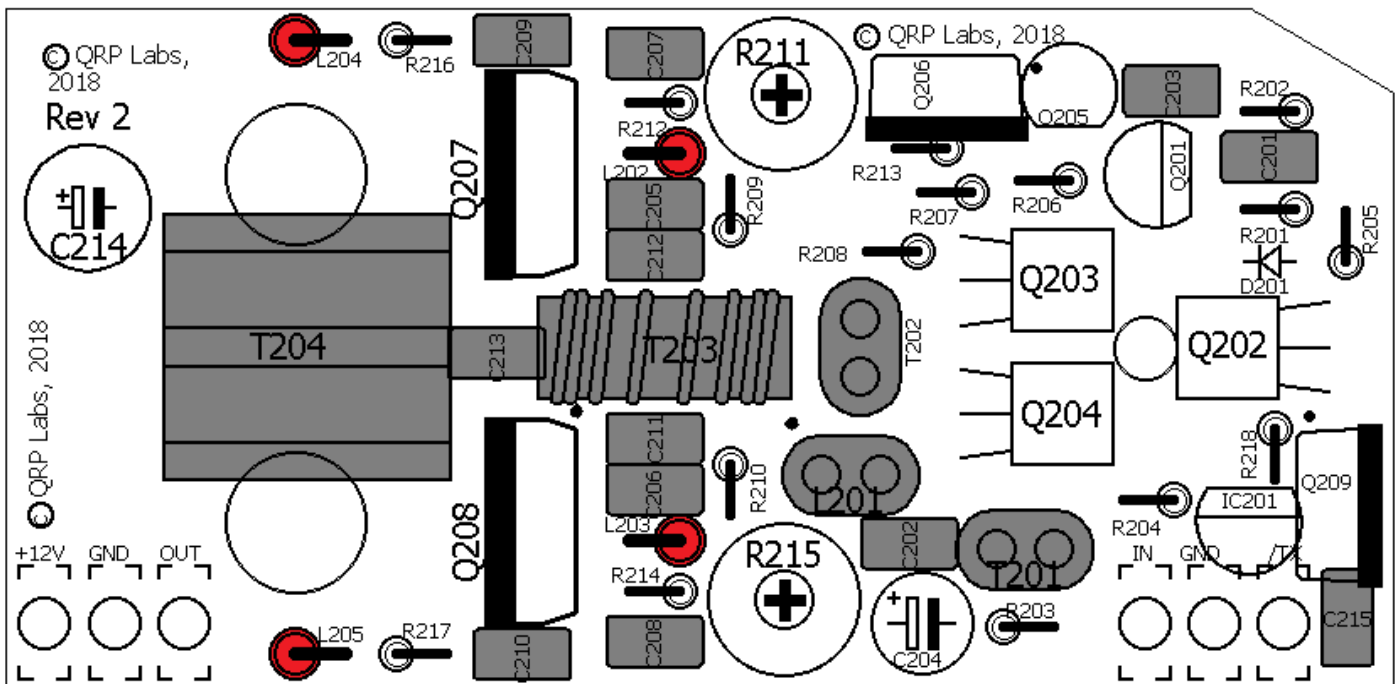
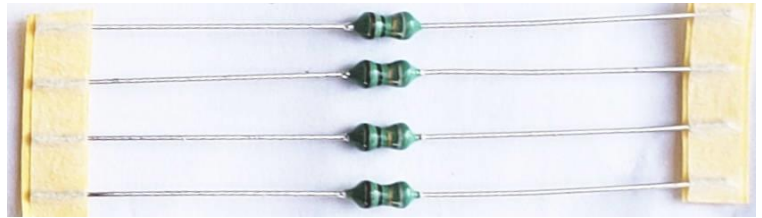

### 3.13 Install resistors R203, R204, R209, R210

These are 220-ohm 0.5W resistors. They have colour code red-red-black-black-brown, but you can also easily identify them because they are larger than the other resistors.

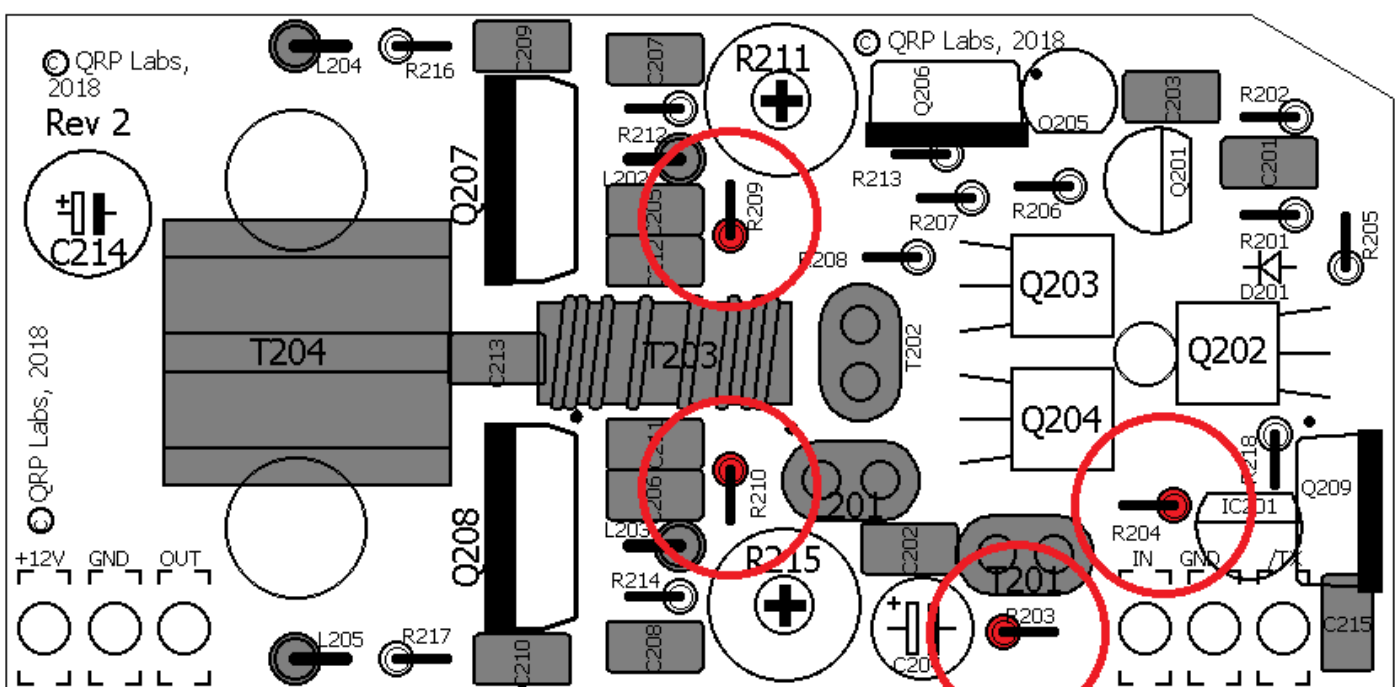

### 3.14 Install resistors R201, R216 and R217

These are 220-ohm resistors with colour code red-red-black-black-brown. Be careful with the identification of resistors on this PA PCB because lots of them start with colour code red-red.

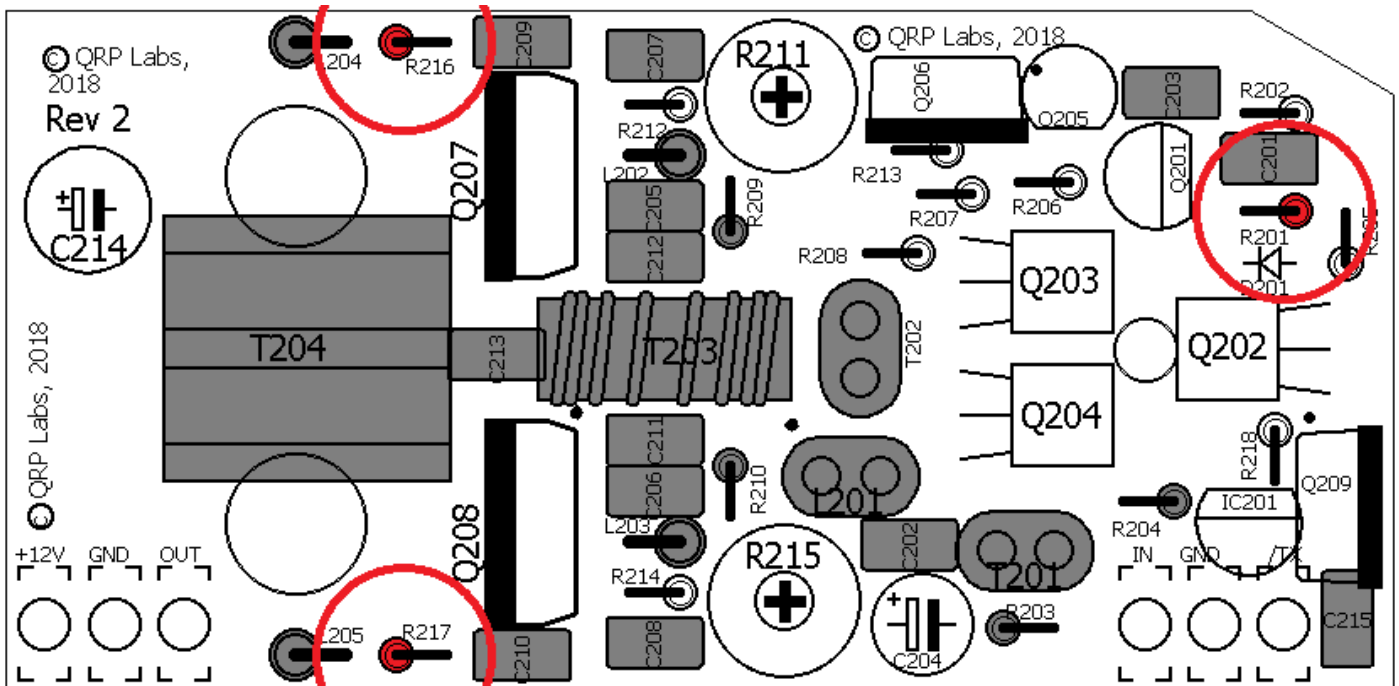

### 3.15 Install resistors R207 and R208

These are 2.2-ohm resistors with colour code red-red-black-silver-brown.

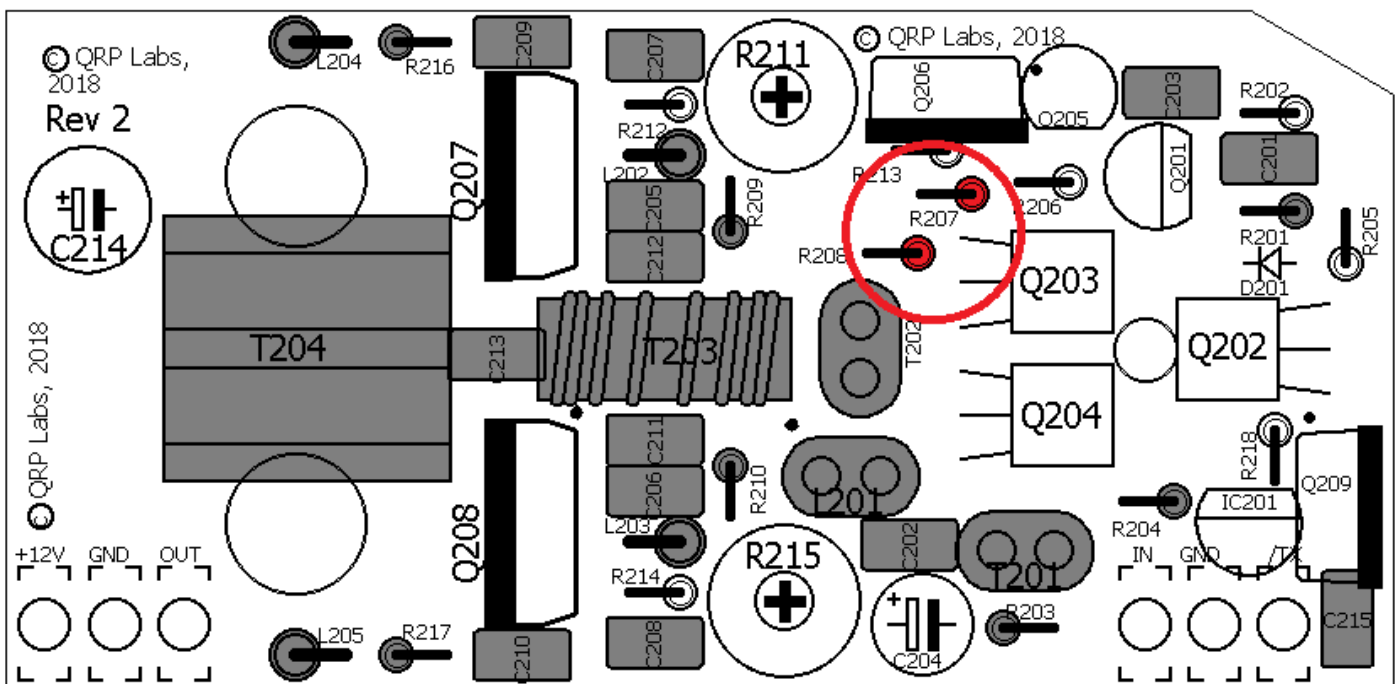



### 3.16 Install resistors R213 and R218

These are 10K resistors with colour code brown-black-black-red-brown.

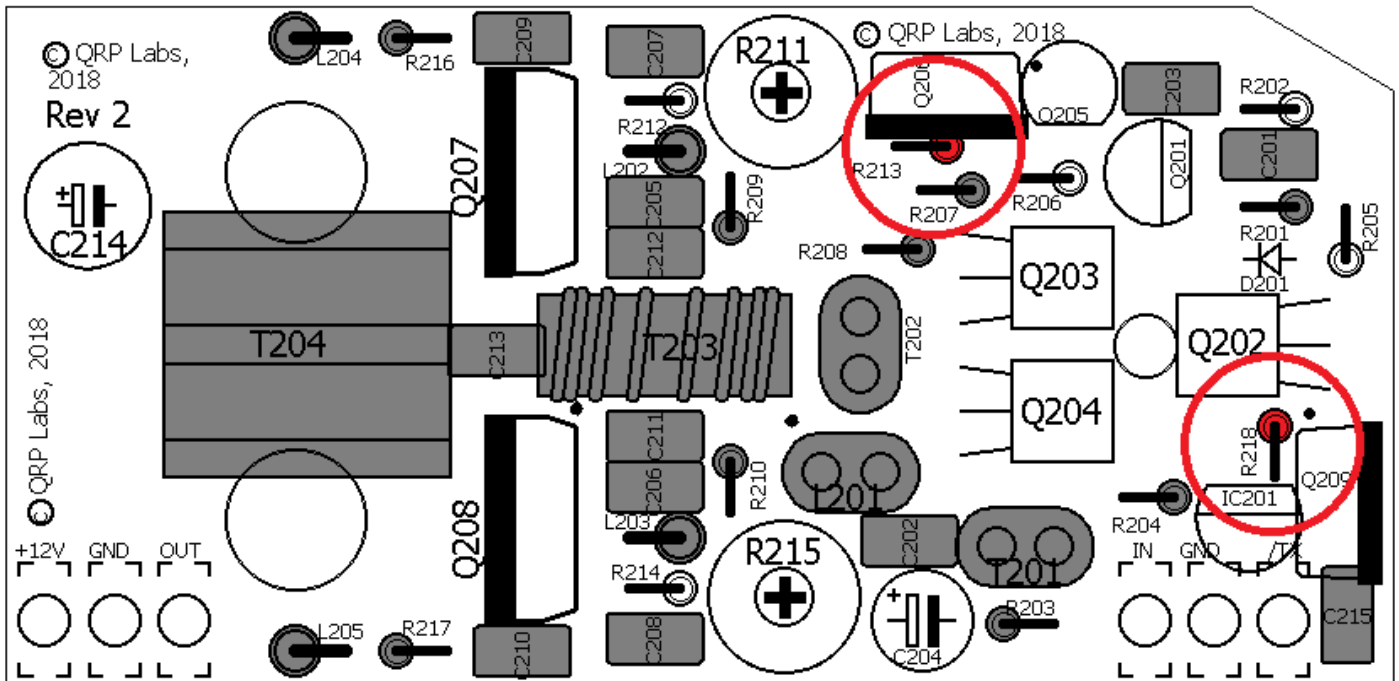

### 3.17 Install resistors R212 and R214

These are 47-ohm resistors with colour code yellow-purple-black-gold-brown.

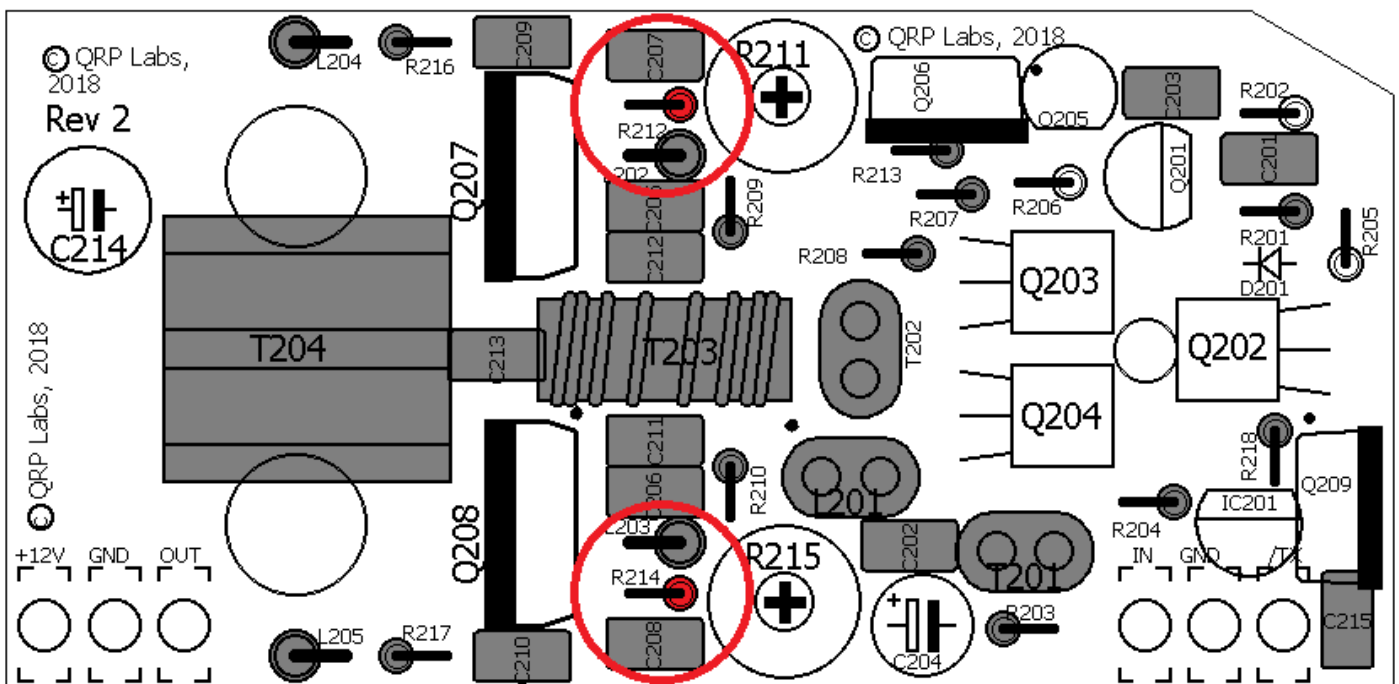

### 3.18 Install resistor R202

R202 is a 22K resistor colour-coded red-red-black-red-brown.

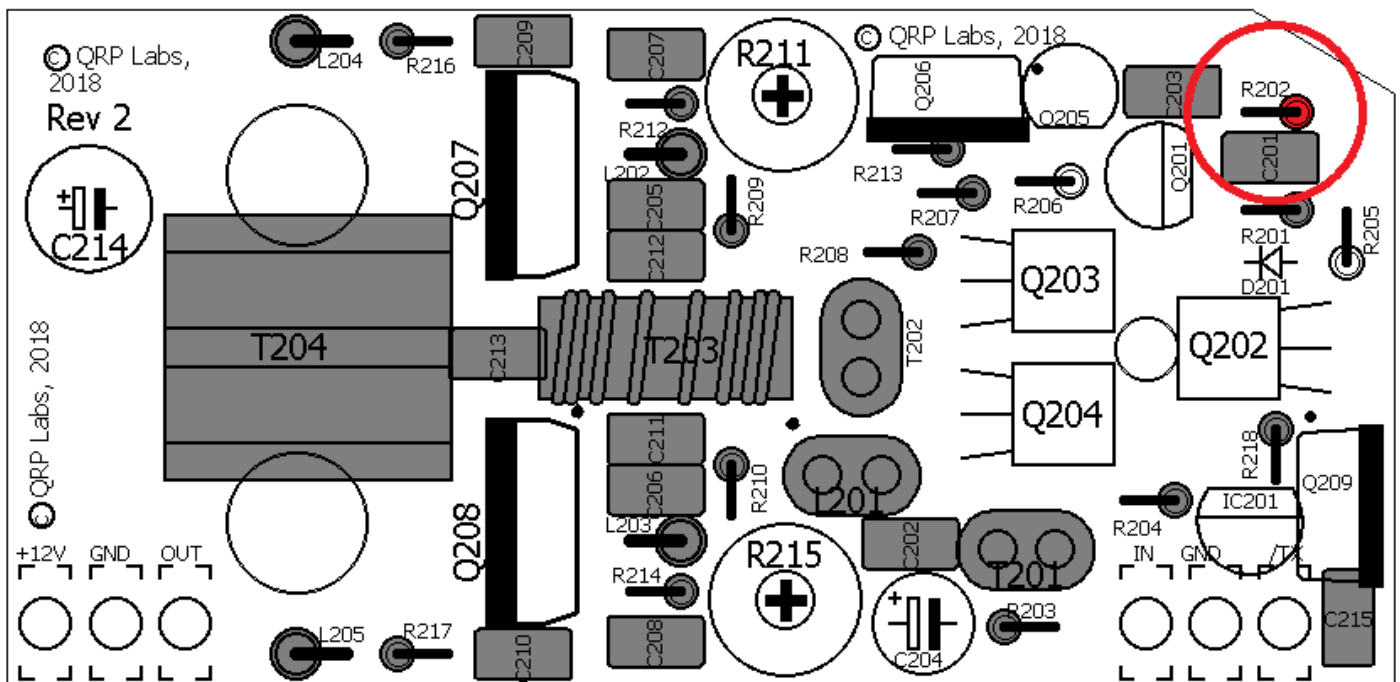

### 3.19 Install resistor R205

R205 is a 2.2K resistor with colour code red-red-black-brown-brown.

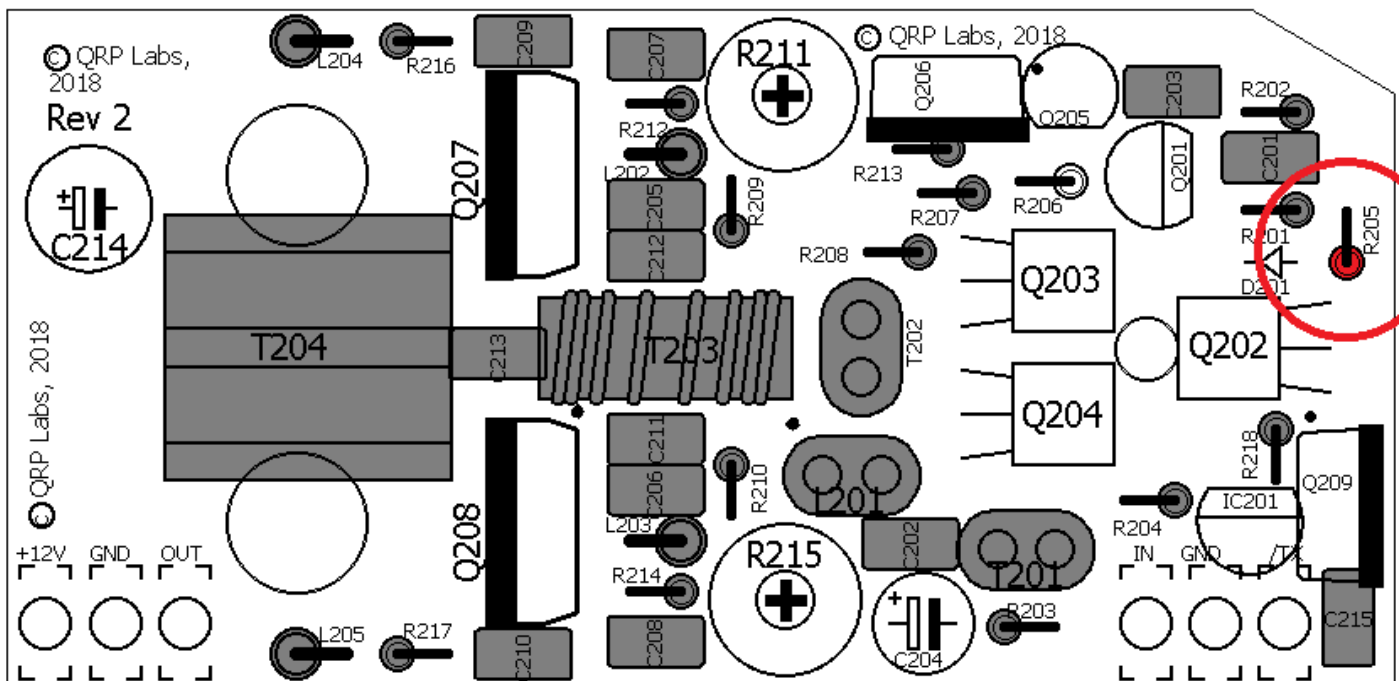

### 3.20 Install resistor R206

R206 is a 33-ohm resistor with colour code orange-orange-black-gold-brown.

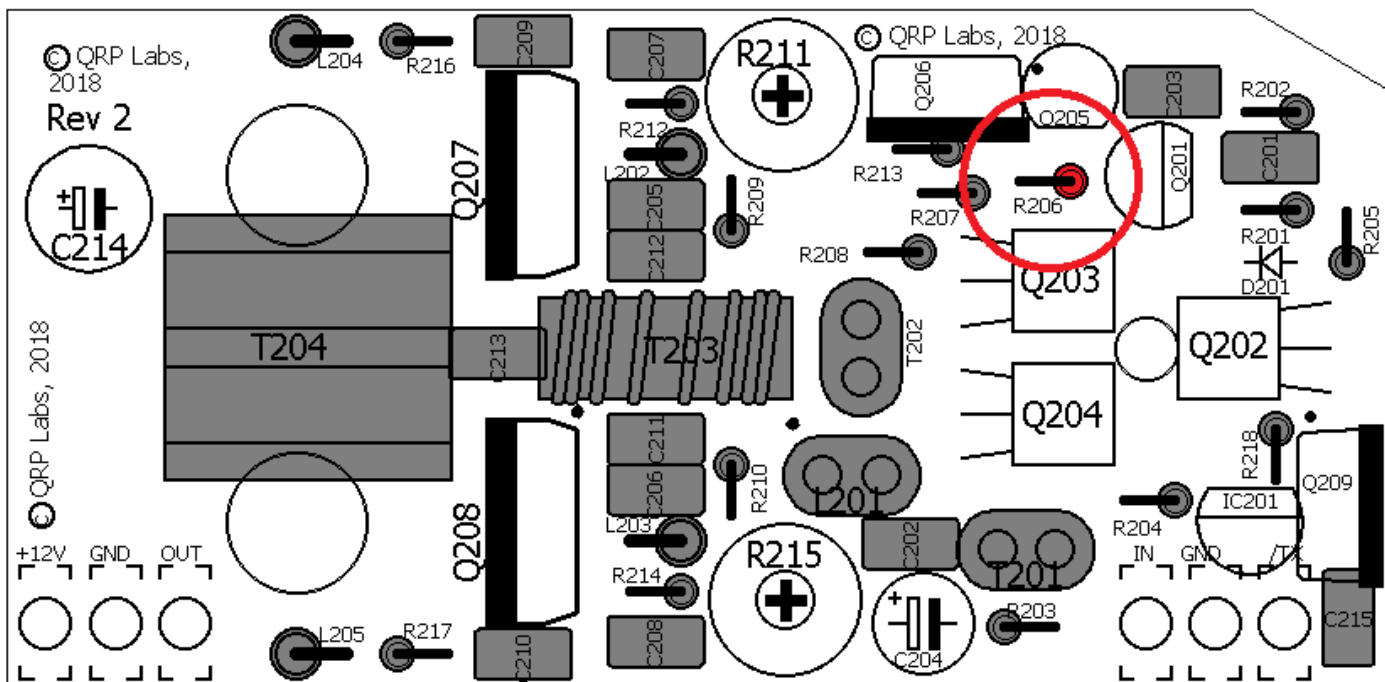

### 3.21 Install trimmer resistors R211 and R215

These are trimmer resistors, with code "472"

**Rotate the trimmer potentiometers all the way anticlockwise at this time!**

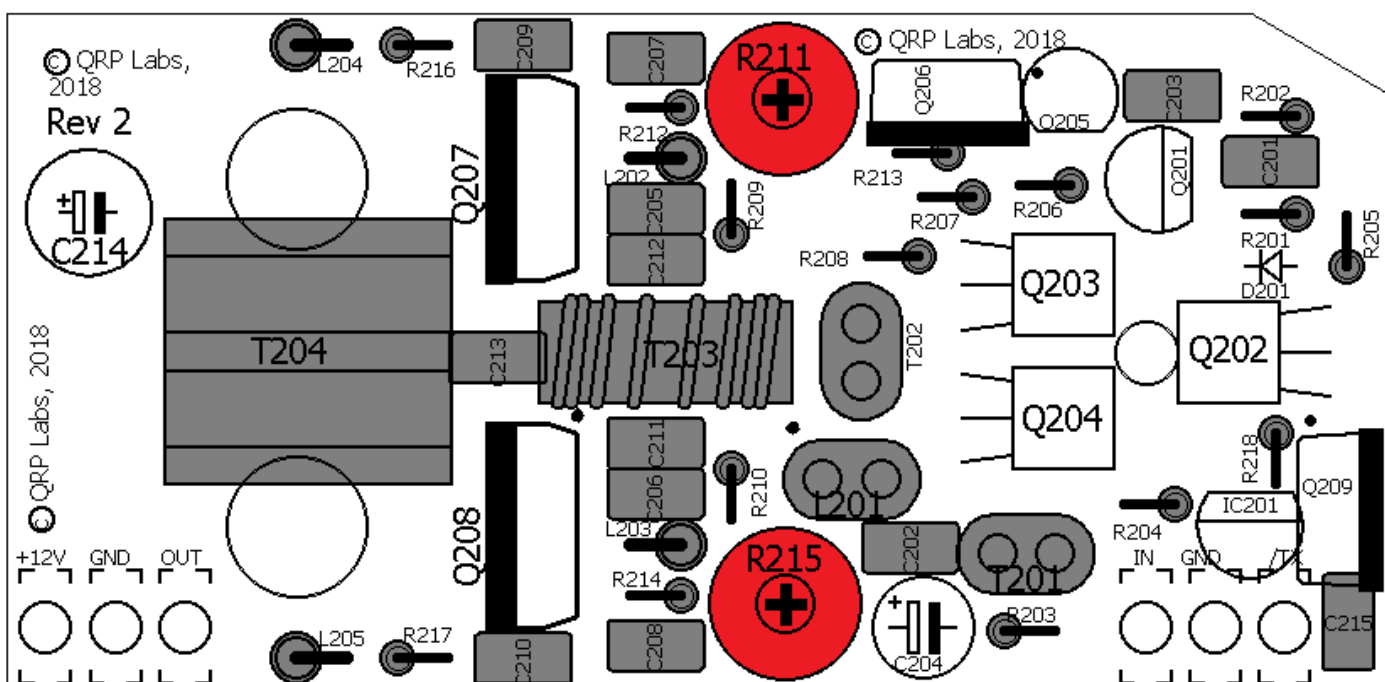
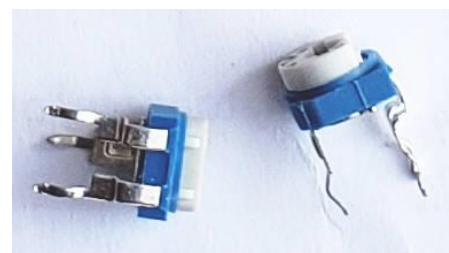

### 3.22 Install capacitor C204

C204 is a polarized 10uF electrolytic capacitor. As previously, ensure that the capacitor is orientated correctly as per the PCB silkscreen. The long wire is positive and must be inserted in the hole marked +.

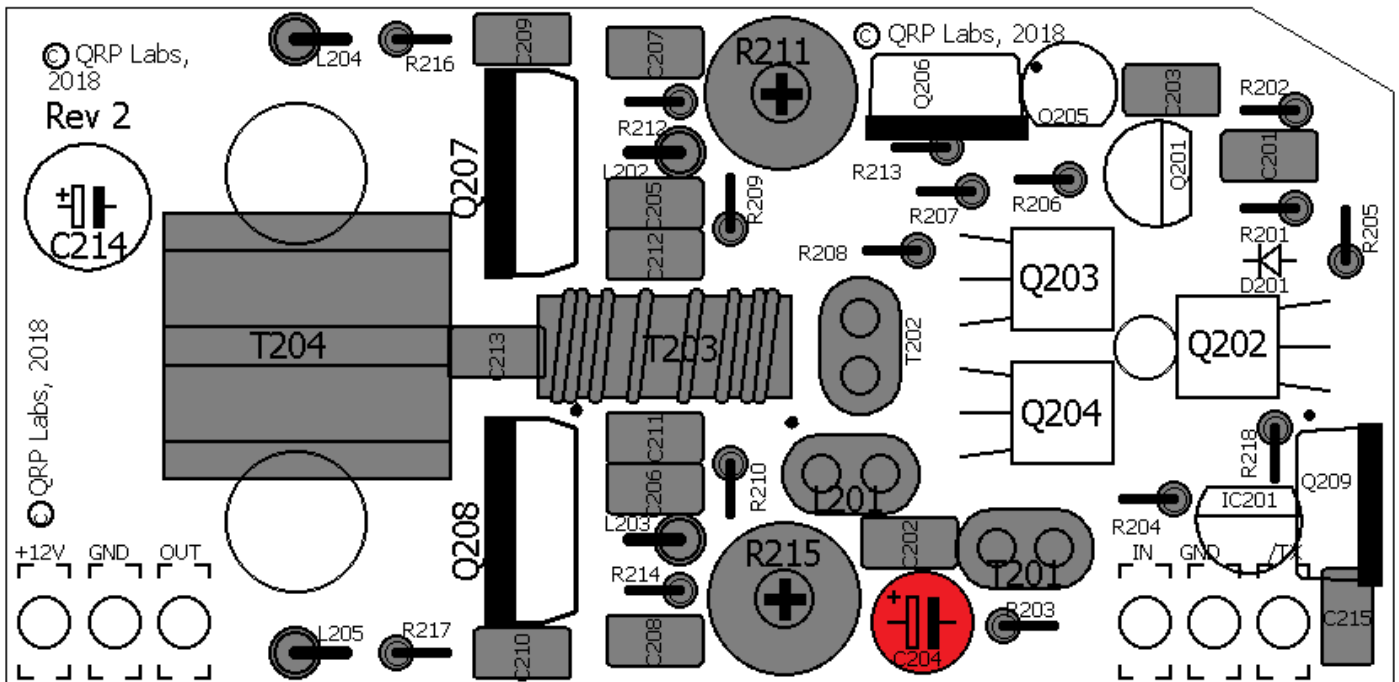

### 3.23 Install capacitor C214

C214 is a polarized 470uF electrolytic capacitor. As previously, ensure that the capacitor is orientated correctly as per the PCB silkscreen. The long wire is positive and must be inserted in the hole marked +.

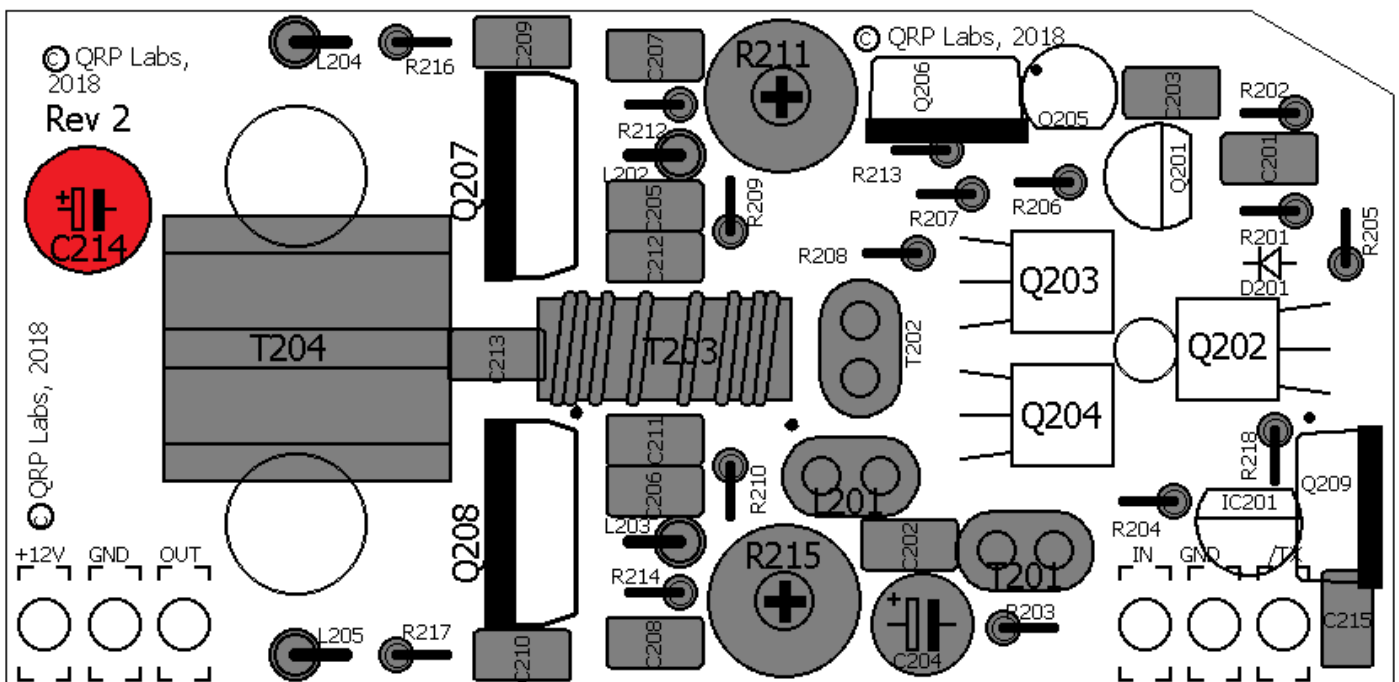



### 3.24 Install diode D201

Diode D201 is the 1N4004 and the direction of installation is critical. The white stripe on the diode body must be aligned with the left-side (bar) of the diode arrow symbol on the PCB. The diode is installed vertically. Bend the wire end in a U-shape, at the end of the diode body OPPOSITE the white stripe. Then install the white stripe end next to the PCB in the left of the two holes, and bent-over-wire-end (non-white stripe end) in the right of the two holes. This makes sure the bent-over wire is not next to the washer of the BS170 installation; therefore, no short-circuit will occur.

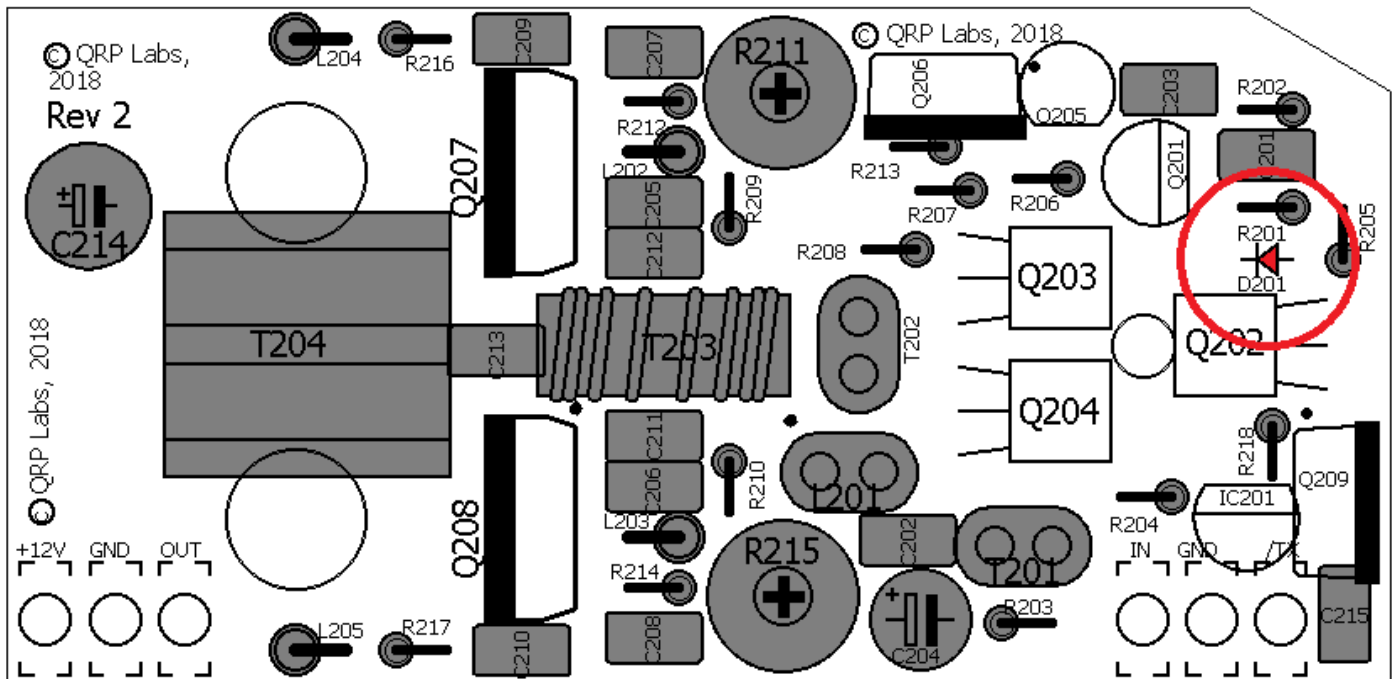

### 3.25 Install transistor Q201

Q201 is a 2N3904 transistor. It looks similar to all the BS170 transistors so check the writing on the component carefully. Bend the middle leg slightly away from the flat face so that it fits the triangular holes on the PCB. Ensure the transistor flat is orientated the same way as the silkscreen flat.

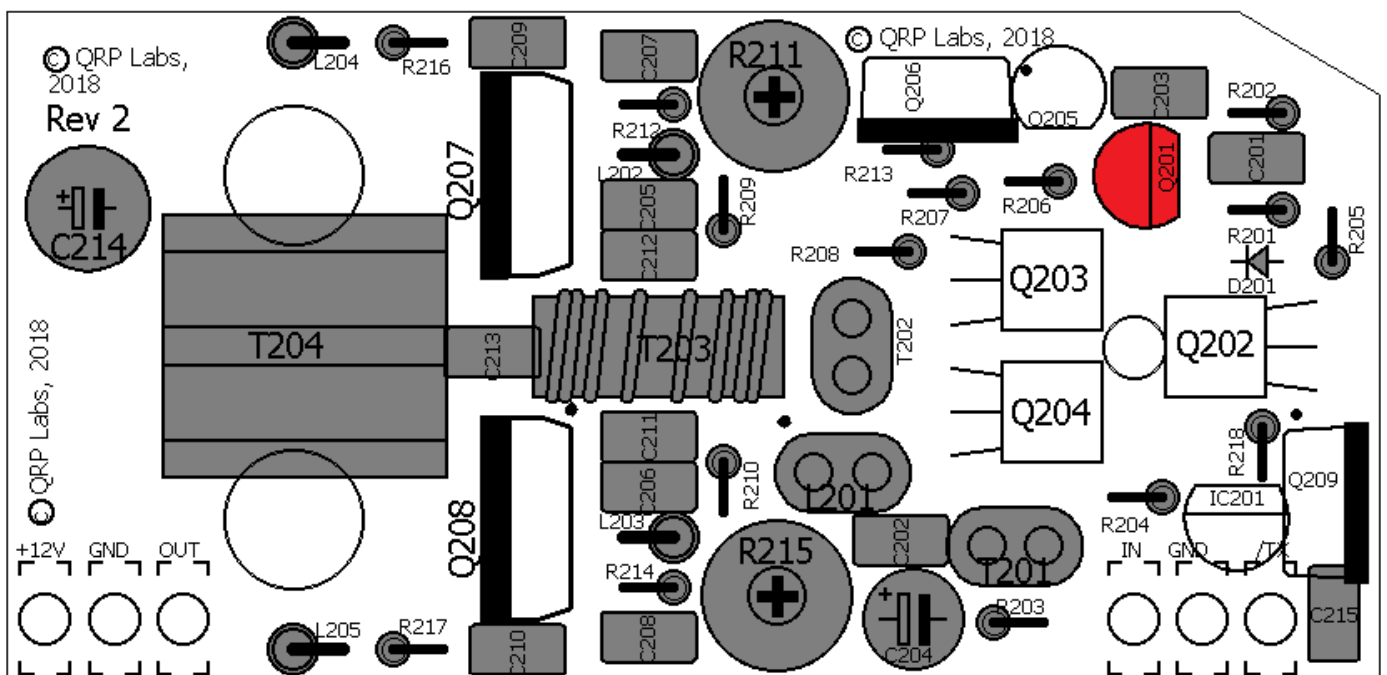
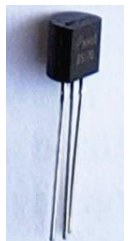

### 3.26 Install transistors Q202, Q203 and Q204

These are BS170 MOSFETs. The transistors should be installed in the positions shown, with their flat faces all facing the hole in the center of the three BS170s.

**Do not solder them yet.** Bend over the transistors so that they lay flat on the PCB, in the rectangular outlines shown on the PCB silkscreen. When the transistors are lying with their flat faces flush against the PCB, and they are not obscuring the hole drilled in the PCB in their center, you can solder them in position.

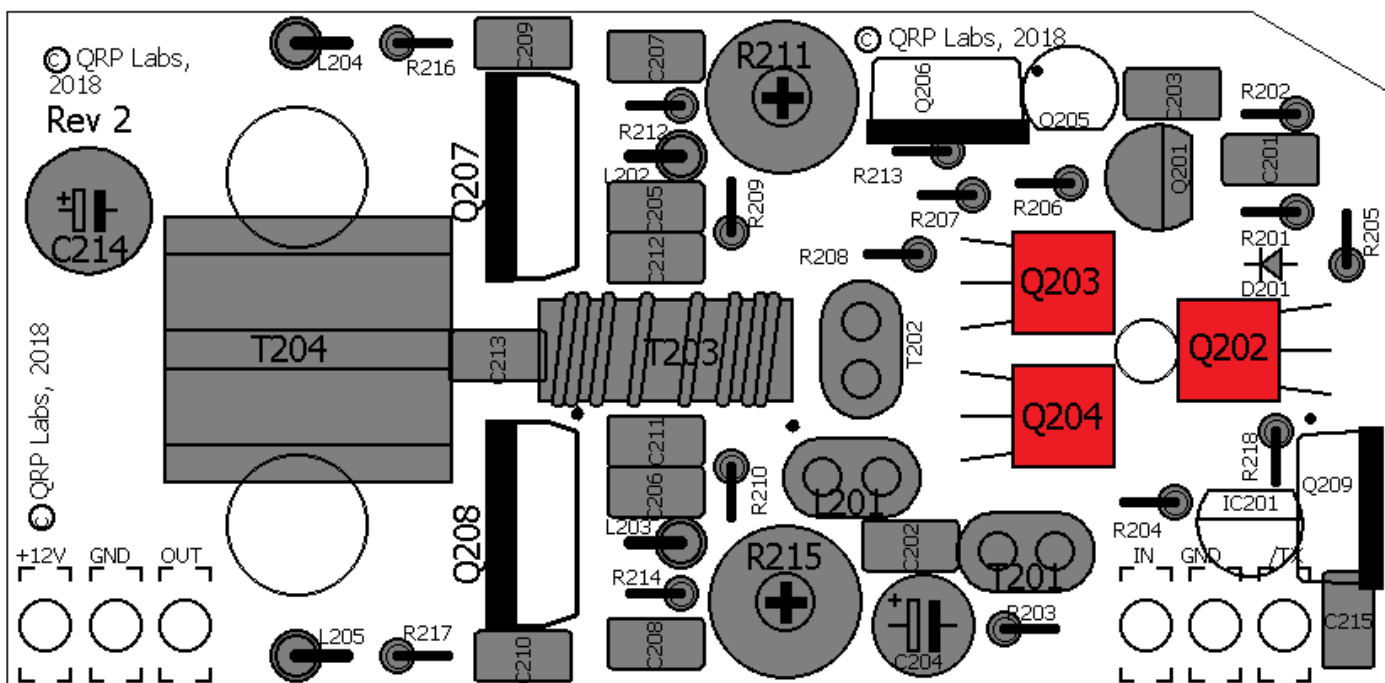
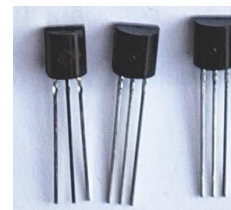

### 3.27 Install transistors Q206 and Q209

These are IRFU9024 P-channel MOSFETs. The transistors must be installed correctly, with the exposed metal pad on the bottom of the transistor aligned with the solid black line of the PCB silkscreen. Inspect the joints with a jeweller's loupe or magnifying glass to be sure the connections have been made.

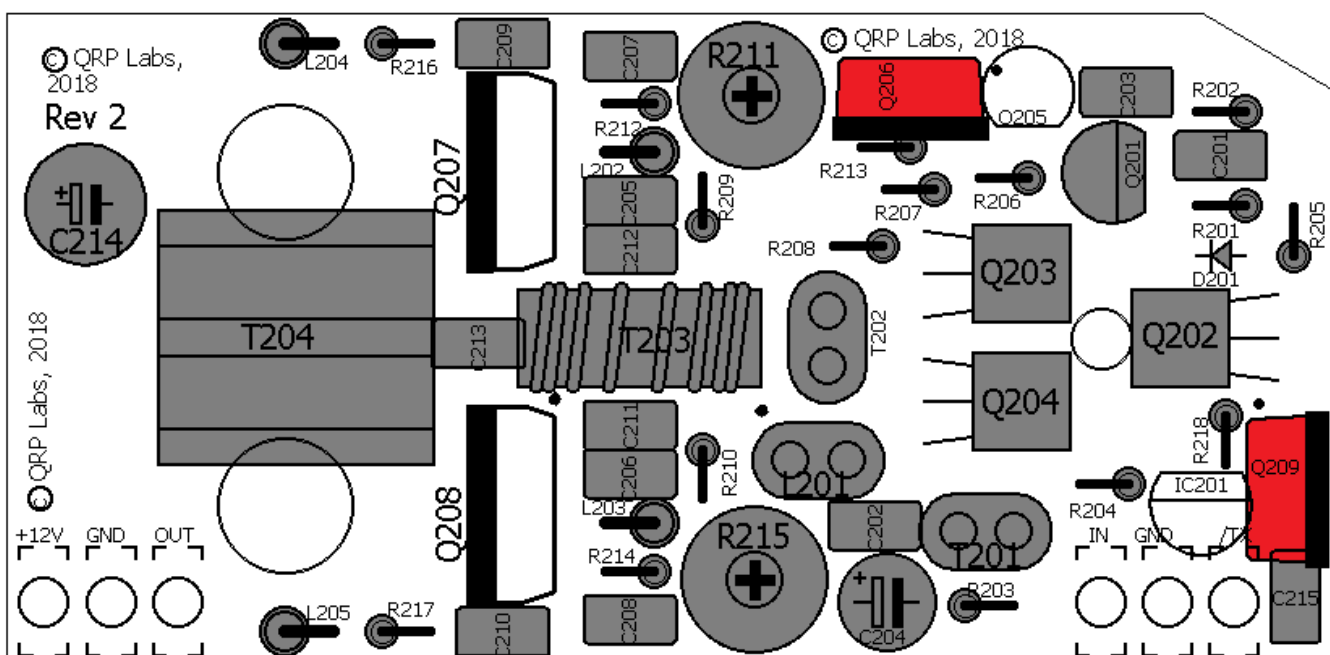
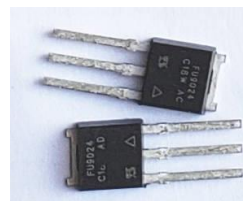

### 3.28 Install transistor Q205

Q205 is a BS170 transistor. Bend the central wire slightly away from the flat face and install it is usual, with the flat on the transistor matching the flat drawn on the PCB silkscreen.

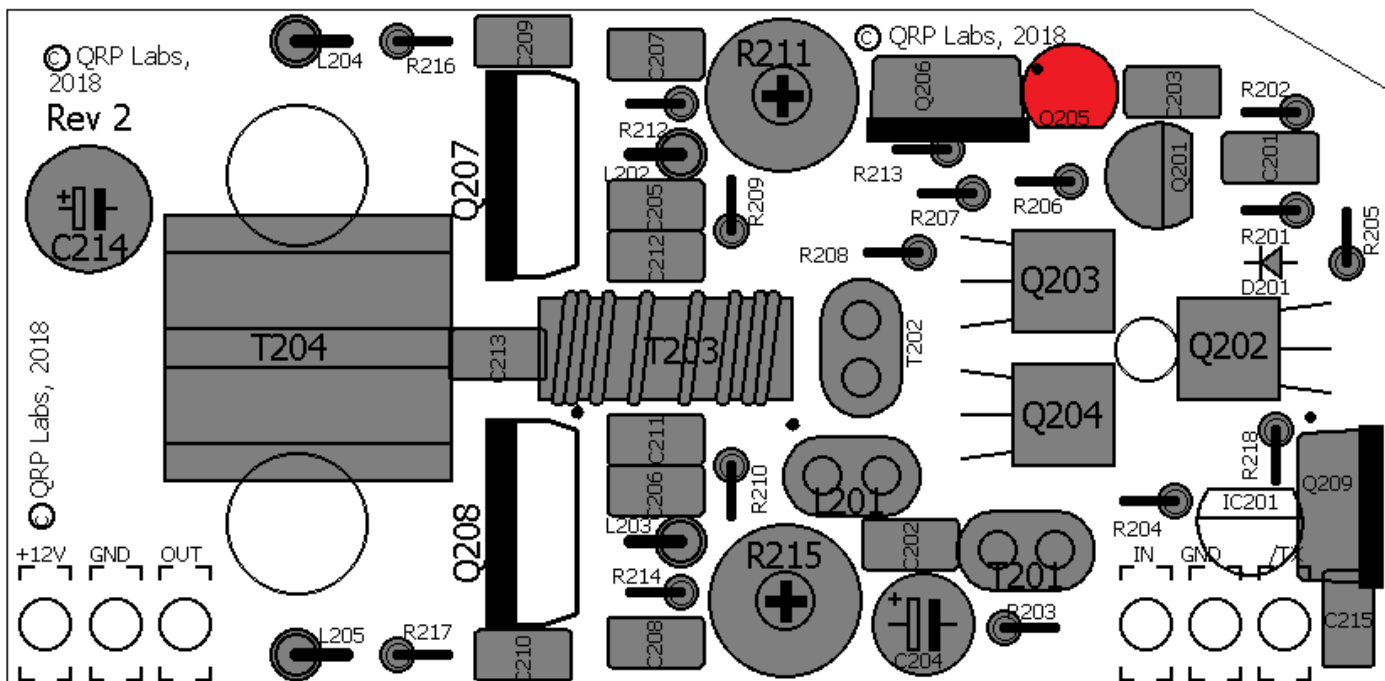

### 3.29 Install voltage regulator IC201

IC201 is a 78L05 Voltage regulator IC in a TO92 package. It looks similar to a BS170 transistor so check carefully that you did not mix them up. Bend the central wire slightly away from the flat face and install it with the flat on the IC matching the flat drawn on the PCB silkscreen. The correct orientation is vital.

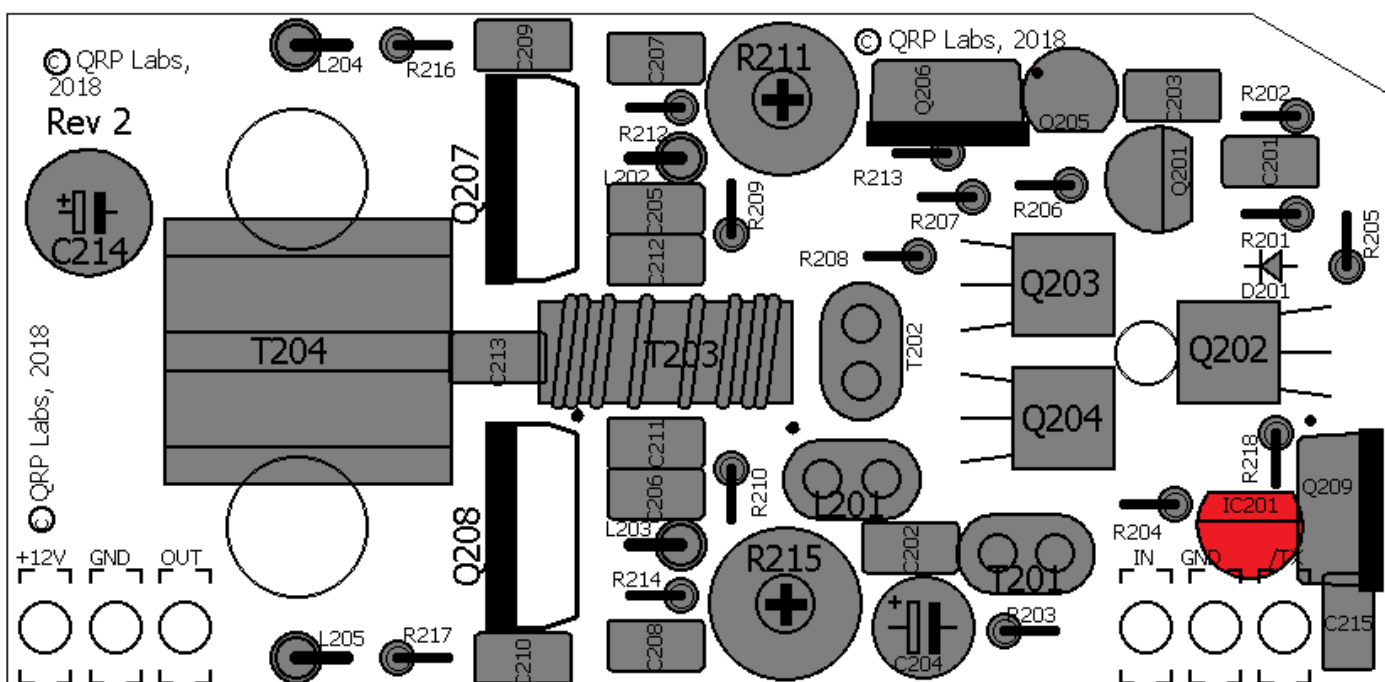

### 3.30 Install transistors Q207 and Q208

These transistors are the power amplifier transistors, IRF510 MOSFETs.

These transistors must be installed on the **BOTTOM** of the board so that they can be bolted directly to the heatsink.



The leads of the IRF510 must be bent upwards through 90-degrees immediately at their exit-point from the IRF510 body. **You only get ONE chance at this – if you bend them the wrong way and you try to bend them back to correct it, the wires will snap off.** The following three photographs all show the IRF510 with the leads bent correctly.

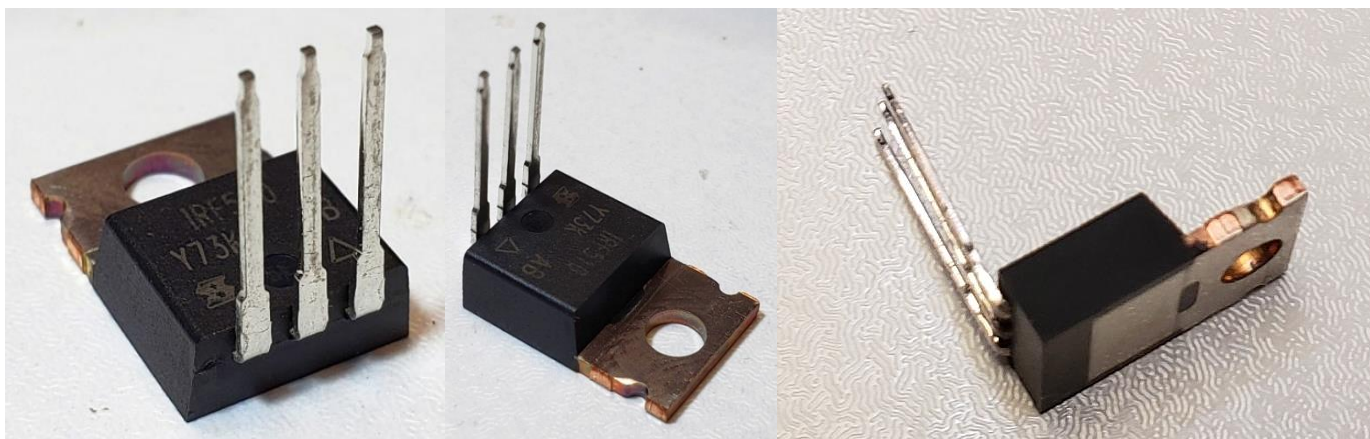

Check the photos and diagrams on the following pages. Now insert the IRF510 from below the board, and solder them on the top side (component side) of the board. OR...

**NOTE:** you could bolt the transistors to the heatsink **BEFORE** soldering. This would make it easier to align the blue silicone insulating pads, and insert the white plastic washer. Refer to the diagrams in the following section for details.

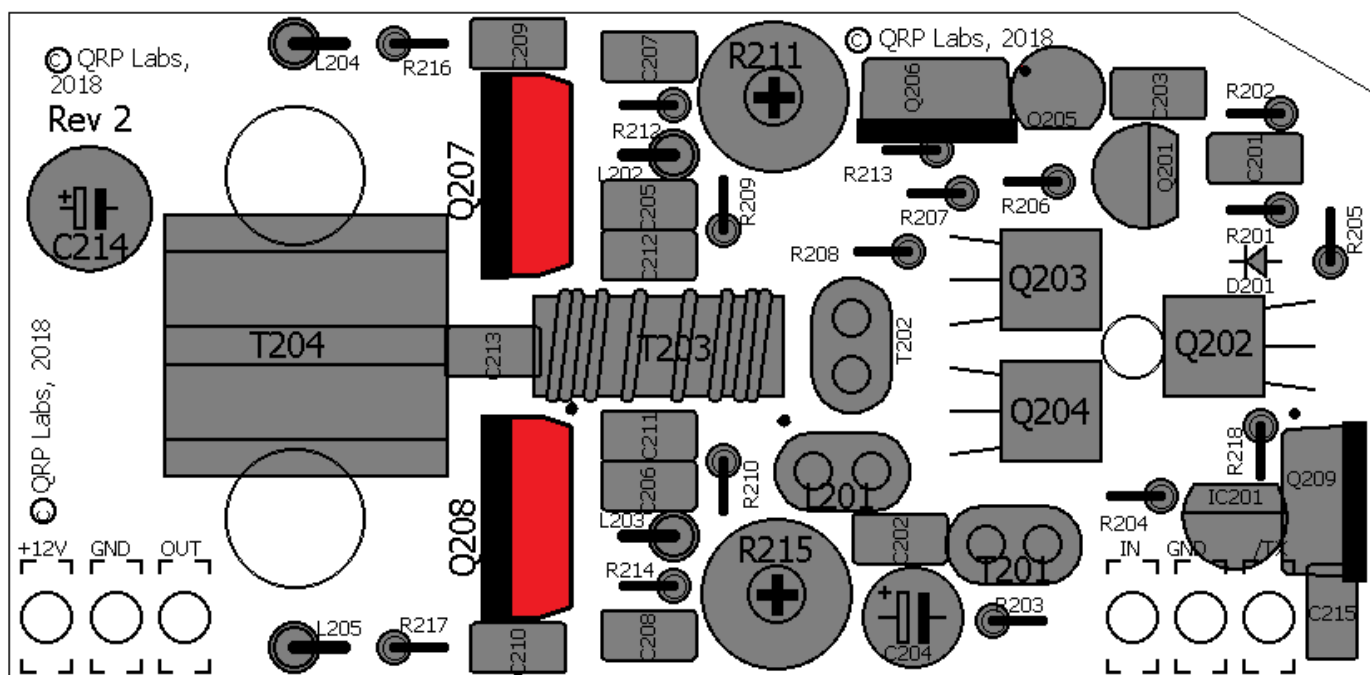



See below for a photograph of the PCB bottom view. Check it before soldering Q207/8.

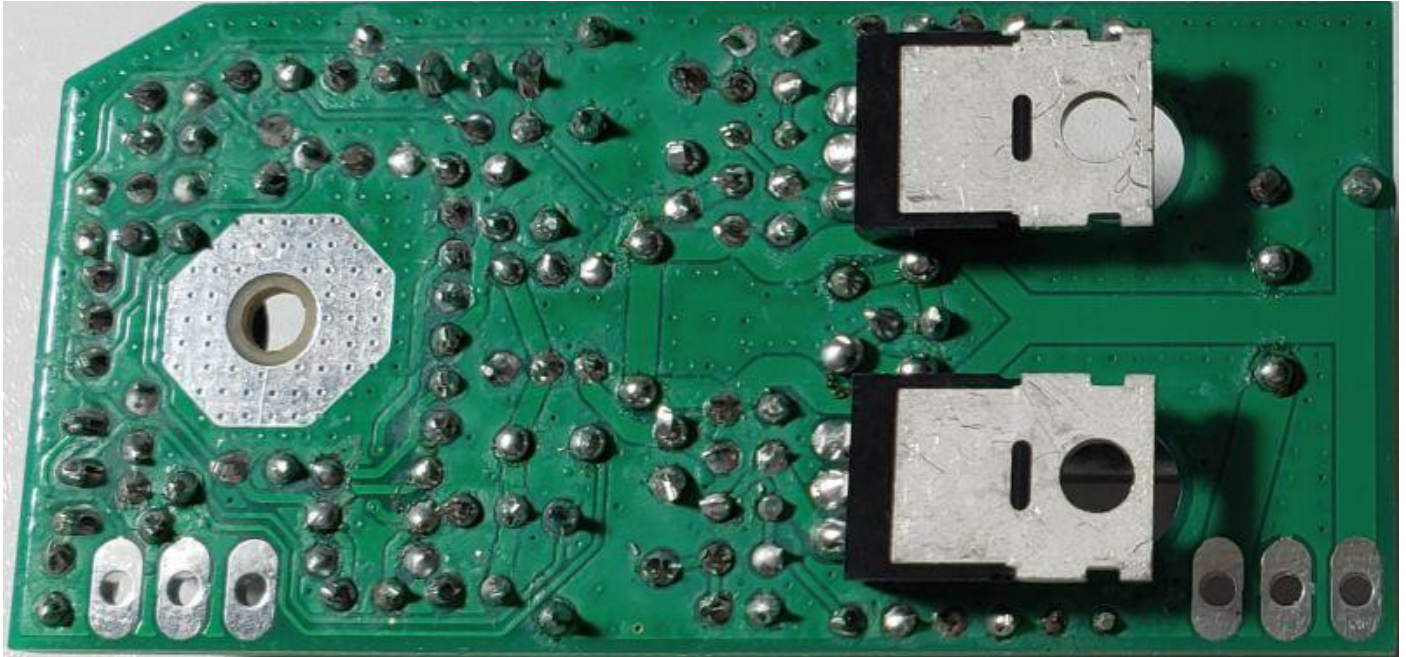

The top view of the completed PA board looks like this. (Note, here the board is shown mounted on the heatsink, by three nuts, one on each of the IRF510s and one on the BS170 driver assembly).

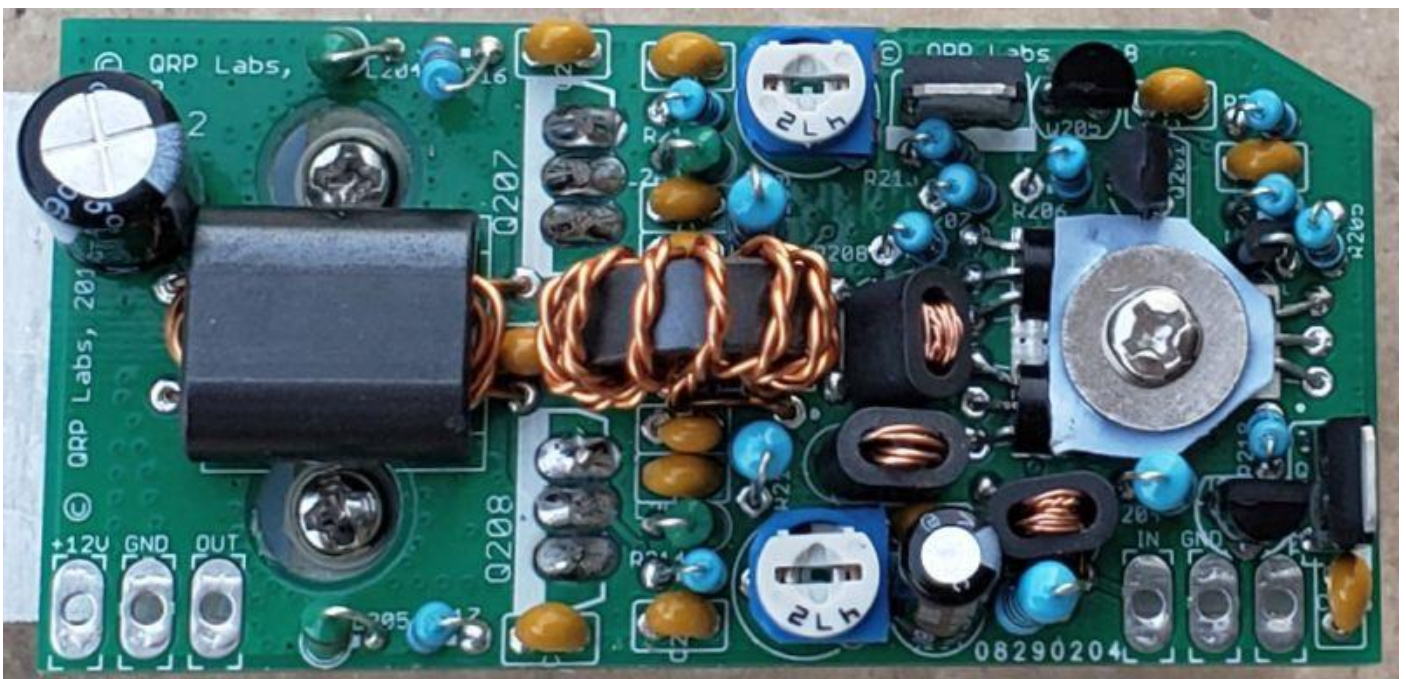

### 3.31 Install heatsink

Depending on your intended application, you may wish to postpone installation on the heatsink, for example until after you have wired the PA board into your project; or after it has been installed in an enclosure. An aluminium rear panel may be bolted between the transistors and the heatsink.

This cross-section diagram indicates the intended mounting of the PA driver stage (three BS170 transistors, pressing them against the PCB and conducting heat via the large M6 nut, to the heatsink.

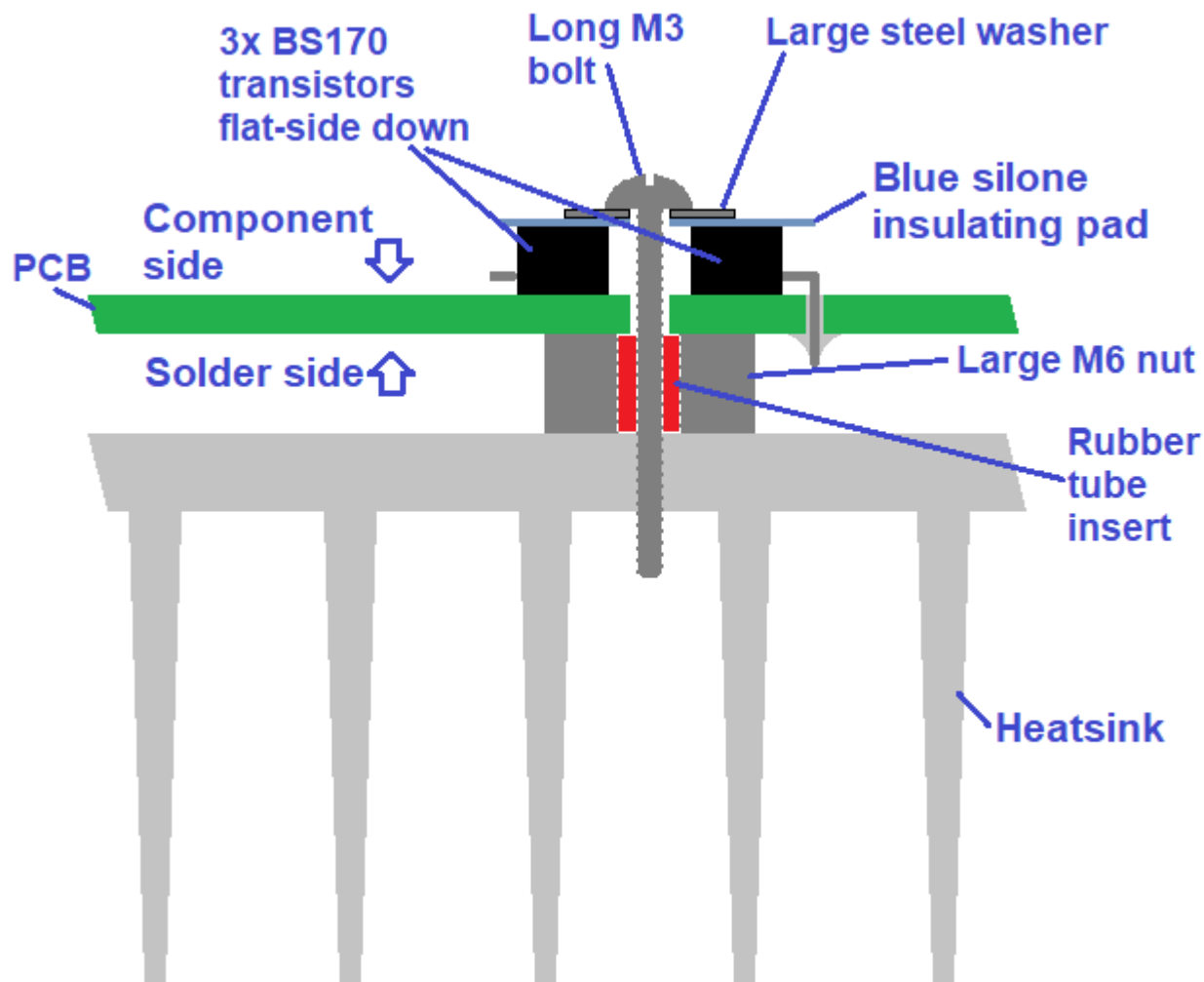

- 1) Cut the blue silicone insulating pad so that it is shaped as shown.
- 2) Place the pad on top of the PA BS170 transistors Q202, Q203 and Q204.
- 3) Thread the large washer onto the 15mm M3 bolt, pass the bolt through the silicone insulating pad and through the hole in the PCB, at the center of the three BS170 transistors.



- 4) Insert the 4mm rubber tube into the M6 nut, as shown. The reason for the rubber tube is that it keeps the M6 nut central on the bolt; otherwise it could touch nearby solder connections and cause a short. Thread this onto the 15mm bolt that was passed through the PCB, in step 3. This nut will act as a spacer between the PA PCB and the actual heatsink. It is also a heat conduit from the PCB to the heatsink.

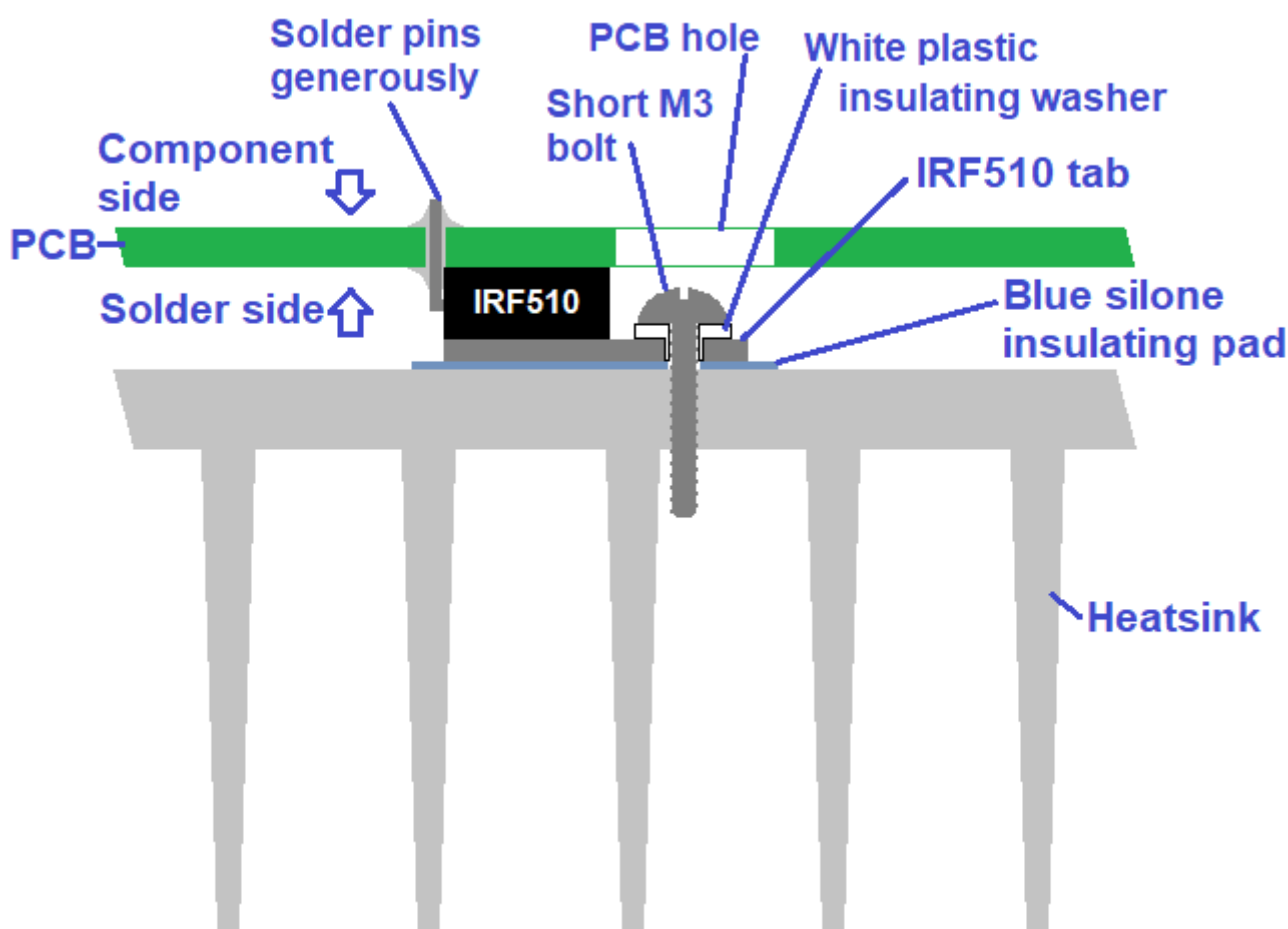

- 5) Insert the two white plastic insulating washers into the holes in the IRF510, and pass through the two 9mm bolts.
- 6) On the bottom of each IRF510 tab, put one of the remaining two blue insulating TO220 pads. It is very important to make sure that the pad completely covers the IRF510 tab. It has to insulate the tab because the tab must not touch the heatsink which is grounded. Check with a DVM to make sure there is no short between the heatsink, and the tab of the IRF510 transistors.
- 7) The heatsink contains two more holes, which can be used for mechanical mounting in your project, or for additional devices e.g. 7805 voltage regulator. These holes are used when the Linear amplifier is installed in the QSX transceiver kit.
- 8) Now tighten all the bolts. Make them tight, but not so tight that you risk breaking threads and/or never being able to undo them ever again.

- 9) Finally it is very important to check now, that there is no short-circuit between the tabs of the IRF510 and the heatsink. To do this, you can put the DVM probes between GND and the +12V bus. A convenient place to do this, is at the connections of the PA PCB to the main rear PCB. The leftmost two wires are +12V and GND respectively. You can touch the probes to these connection points, with the board assembly upside-down.
- 10) When powering up the radio, it is best to use a current-limited supply, set to 300mA, as a final precaution.

## 4 Applications information

### 4.1 PA Precautions

To avoid dramatic failure of components, observe the following precautions:

- 1) Check all the components again, and again, BEFORE applying power to the amplifier! Check the resistors are in the correct places, check that all the enamelled wire inductors and transformers are properly soldered with continuity through the windings. Check that the capacitors are installed correctly (with the correct polarity). The same applies to diodes, transistors and the voltage regulator IC. Pay particular attention to ground connections of all components: A very common fault is failure to apply adequate heat to ensure a good solid joint to ground – the groundplane will dissipate heat and draw it away from the joint.
- 2) Before applying power, make sure the two trimmer resistors (PA bias) are turned all the way anticlockwise.
- 3) Check for short-circuits between the IRF510 metal tab, and ground! Check that there are no other shorts, the DC resistance between the +12V tab and Ground should not be near zero.
- 4) Do not apply power to the amplifier unless the heatsink installation has been performed and all screws are tightened.
- 5) Always use a Low Pass Filter between the Amplifier output and your antenna system.
- 6) On first powering up the amplifier, and during adjustments, use a current-limited supply. If anything does go wrong, you'll have more time to notice it before letting the smoke out.

### 4.2 Connections

This amplifier has 50-ohm RF output. Input impedance and VSWR will vary. If you require precise 50-ohm input then use a 6dB Pi-network pad; this will reduce the gain by 6dB of course. It requires a good solid DC power supply of 12V to 14V capable of supplying up to 2.5A current. Use thick wires to connect the power supply to the amplifier, to avoid unwanted voltage drop.

Keep the input RF away from the output RF. These connections are at opposite ends of the board, to avoid unwanted feedback which could result in instability.

The /TX input connection switches on the bias to the PA transistors. This is an Active Low input: it should be driven to Ground to switch on the bias.



## 4.3 Adjustment

The only adjustments required are the two trimmer resistors which set the final PA transistors (IRF510) bias currents. Make sure the trimmer resistors are initially turned all the way anticlockwise.

Apply power, while observing the current consumption. You can do this with a power supply with current metering, or using a DVM in series with the power supply.

Connect the /TX input to ground, to switch on the amplifier. Do not apply any input RF at this stage.

Observe the current consumption on the current meter.

Adjust one trimmer resistor, turning it very carefully and slowly clockwise, and look for a current INCREASE (on top of the observed initial current reading) of 125mA.

Adjust the other trimmer resistor, again very carefully, for a further increase in current consumption of 125mA.

Once both PA transistor bias has been adjusted for 125mA (total 250mA) this sets up the Linear Power Amplifier for optimal performance operation.

## 4.4 Tests undertaken

The following tests were undertaken by Allison KB1GMX on a production unit. They have been reproduced on three different kit assemblies.

**In all of the tests, there were no failures of components and no degradation of performance.**

- 1) Gain: 26 to 28dB, with +/- 1dB gain flatness over the range 2-30MHz. This is shown in the following images.

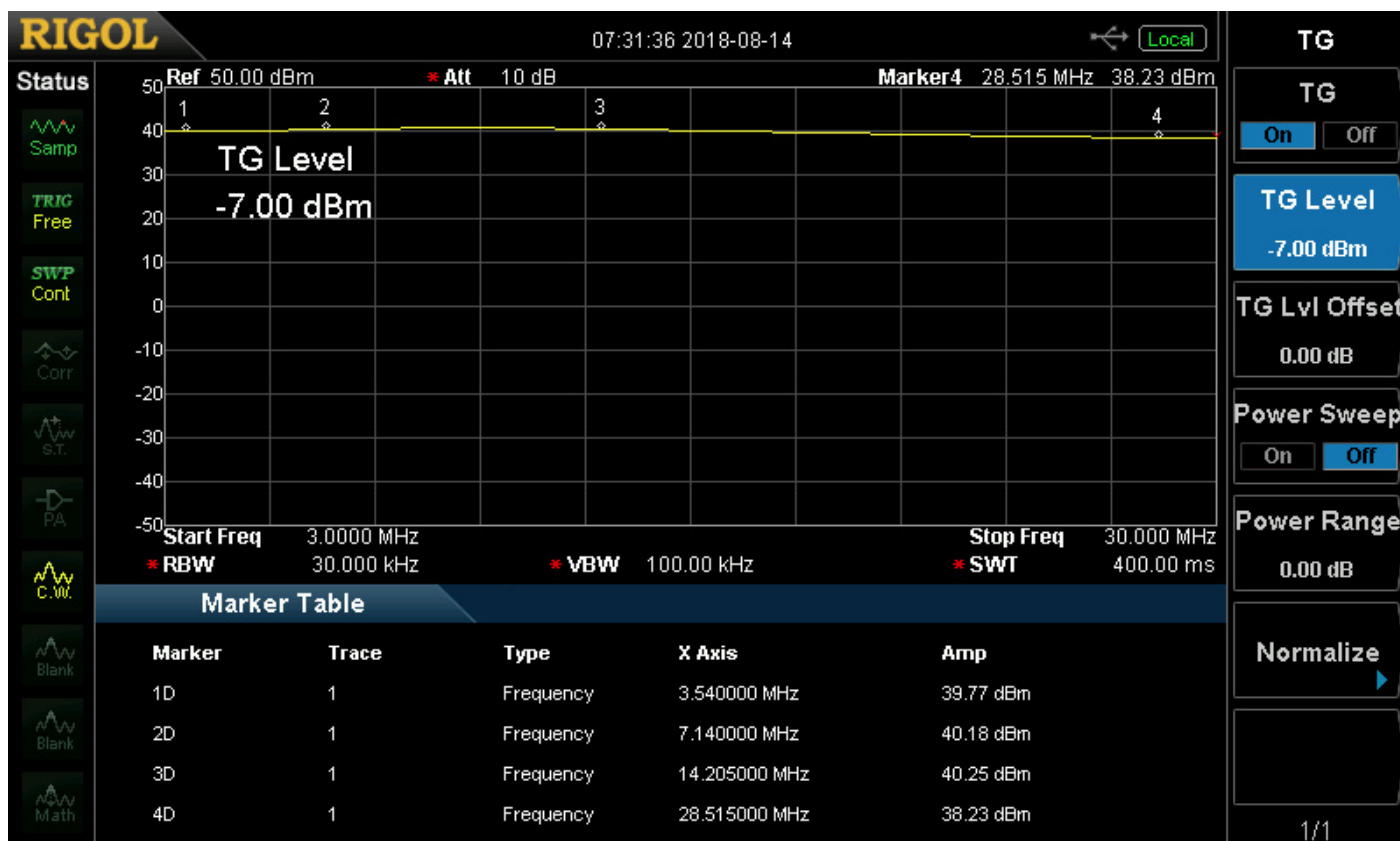

The next image shows the same thing but the vertical scale is expanded to 2dB/division:

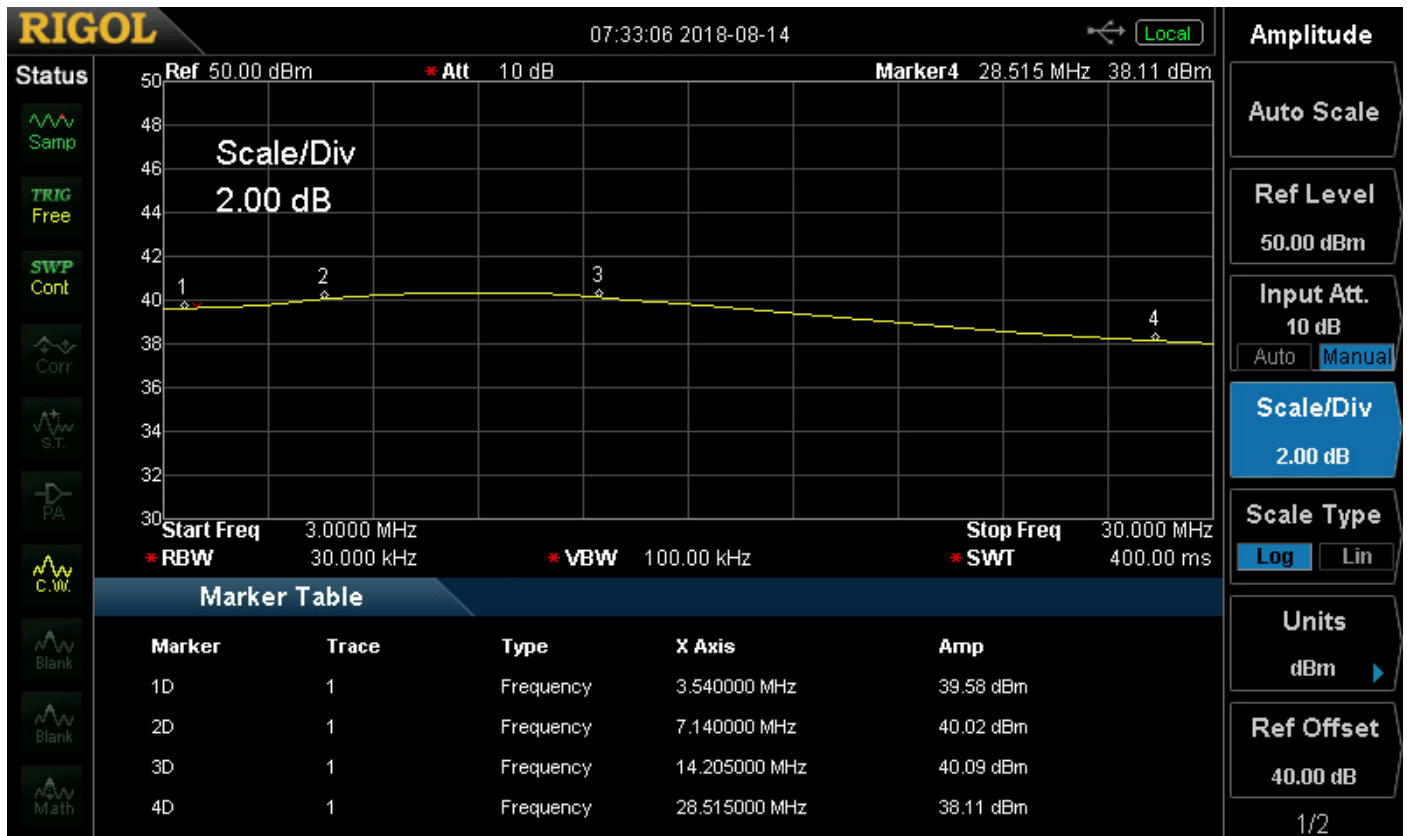

- 2) Operation at full power into open output, shorted output, 20-foot long open cable, open cable with short – all with no oscillation or damage
- 3) Amplifier is still capable of 10W at 50MHz (6m band) though gain is down by 4dB compared to HF
- 4) Gain is 8dB down at 70MHz (4m band) compared to HF
- 5) With sufficient drive, the amplifier is capable of producing 20W output at 13.8V supply using +15dBm input, over the range 3-30MHz
- 6) Operated with +20V supply
- 7) At 10V supply still over 7W output
- 8) A clean 3.5MHz (80m band) source running at 10W output had 2<sup>nd</sup> harmonic at -38dBc and 3<sup>rd</sup> harmonic at -31dBc – very good linearity
- 9) Operated at full-power continuous key-down, 100% duty-cycle for 1 hour, without damage or degradation in performance.

## 5 Version History

1	09-Oct-2018	1.00	First version
2	10-Oct-2018	1.01	Update some typos here and there
3	30-Oct-2018	1.02	Removed “insulated wire 30cm” from parts list (not in the kit). Removed text “50-ohm input”. Updated connections text, commenting on feeding the input if 50-ohms needed.