

QDX: QRP Labs Digital Xcvr (transceiver) Operating manual, firmware 1.05

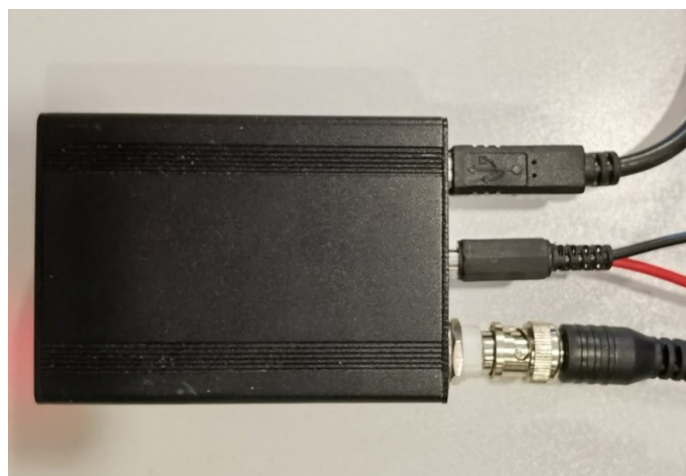
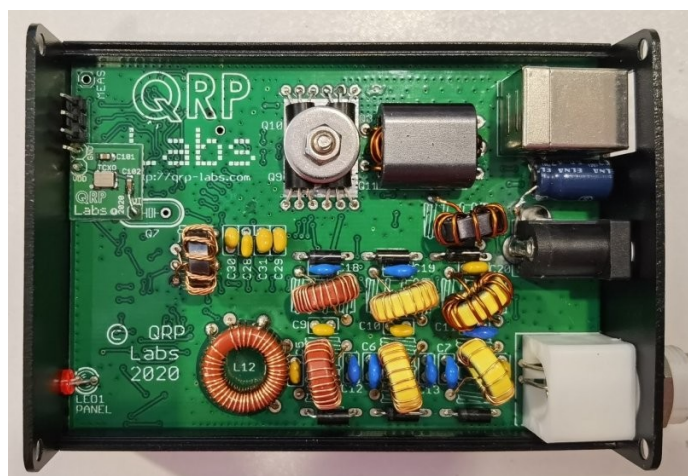
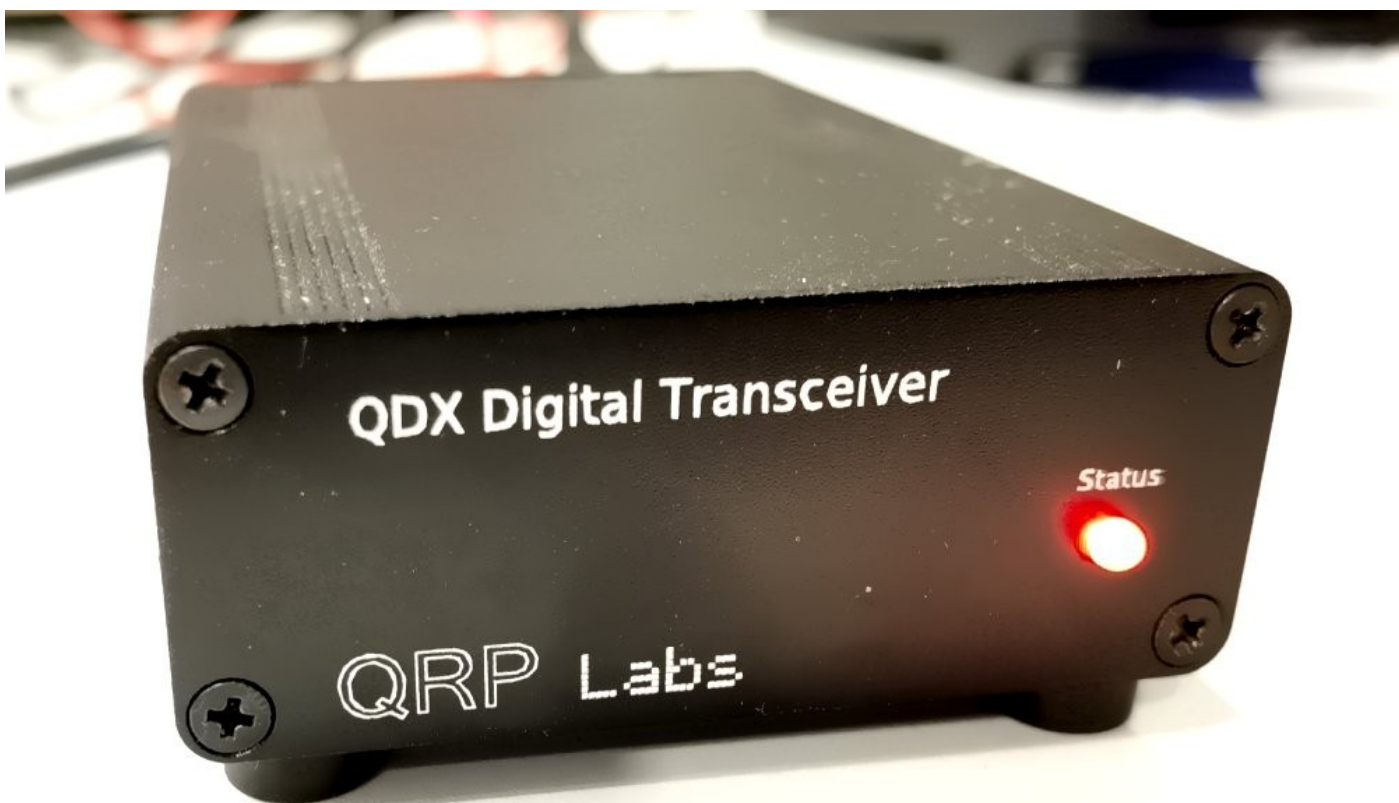

Contents

Contents.....	2
1. Introduction.....	3
2 Operating instructions.....	4
3 Firmware Update procedure.....	10
4 Terminal Applications.....	13
4.1 PC terminal emulator.....	13
4.2 Entering terminal applications mode.....	14
4.3 Exiting terminal applications mode.....	14
4.4 Configuration.....	15
4.5 Band configuration.....	23
4.6 Audio filter sweep.....	26
4.7 RF filter sweep.....	27
4.8 Input analysis.....	28
4.9 Image sweep.....	32
4.10 CAT command test.....	34
4.11 CAT monitor.....	38
4.12 Log file.....	39
4.13 Transmitter test.....	42
4.14 Factory reset.....	43
4.15 Update firmware.....	43
4.16 Exit terminal.....	43
5. Troubleshooting Transmit issues.....	43
6. Resources.....	45
7. Document Revision History.....	45

1. Introduction

The QDX is a high performance, four-band 5W Digital modes transceiver with CAT control and built-in USB sound card. QRP Labs presents QDX, a digital transceiver with a ratio of performance to price not available until now.

- Four band 80, 40, 30 and 20m; 5 W from 9 – 10V supply
- Clean single signal output (zero residual carrier, zero unwanted sideband)
- Solid state PIN-diode switched Low Pass Filters and solid state Band Pass Filters
- Solid state transmit/receive switching
- High performance embedded-SDR SSB receiver using 110dB 24-bit stereo ADC chip
- Built-in USB sound card: 48ksps 24-bit stereo
- Built in USB Virtual COM port serial for CAT control
- Si5351A Synthesized local oscillator with better than 0.001Hz resolution and high precision 25MHz TCXO reference as standard
- Built-in signal generator
- Built-in suite of configuration and analysis tools
- Lifetime free firmware upgrades with QRP Labs Firmware Update (QFU) bootloader for easy firmware update on any OS with no extra software, or drivers, or programming hardware
- All SMD components pre-installed by factory, only through-hole component soldering by the kit constructor
- Receive current: 100mA; Transmit current 1.0 – 1.1A (9V supply, 5W output)
- Only three connectors: USB (audio and serial for CAT), Power and RF
- Optional smart aluminium extruded enclosure measuring just 89 x 63 x 25mm

No test equipment is required to build, align and operate this digi modes transceiver. There are no alignment tasks.

Assembly of the transceiver is covered in a separate document, along with design details (theoretical explanation) and performance measurements.

This document describes operation of QDX, and applies to the firmware version specified. This manual will get you started with QDX and your WSJT-X or other digi modes software in minutes.

PLEASE READ THE BASIC ASSEMBLY AND USE INSTRUCTIONS IN THIS MANUAL VERY CAREFULLY BEFORE APPLYING POWER TO THE BOARD!

2 Operating instructions

Operation of the QDX transceiver is really simple. There are only three/four connections:

1. DC Power: use a regulated well-smoothed DC supply of not more than 12V; it should be capable of up to 1A current supply. The connector is a 2.1mm barrel type (outside diameter 5.5mm).
2. RF: a standard BNC connector to your antenna system
3. USB: USB type B connector (a standard USB type A to B cable is required) for Audio and CAT control.
4. PCB Rev 3 (and corresponding enclosure Rev 3) has a 3.5mm jack connector as a PTT output; it can drive grounded or +5V PTT signal requirements and/or can be used for external auxiliary controls such as antenna switching if desired.



Drivers

No additional drivers are required for operation with most Linux distributions, Apple Mac or MS Windows 10 or Windows 11.

For older versions of MS Windows, it may be necessary to install a driver for the serial port because this driver is not on your computer already by default. This driver is available from the ST Semiconductor website at <https://www.st.com/en/development-tools/stsw-stm32102.html> and is applicable to 98SE, 2000, XP, Vista®, 7, and 8.x Operating Systems. There is a description for installation on Windows 7/8 on the QRP Labs QL2 page <http://qrp-labs.com/qlg2> so if in doubt, please check this.

Linux special note

On Linux systems, a particular problem can occur. When the QDX Virtual COM (Serial) connection is detected, the PC thinks that a modem has been connected and starts trying to send it Hayes AT-commands dating back to 1981, implemented on Hayes' 300-baud modem. Yes! 40 years ago...

The Operating System attempting to send AT commands to your QDX will certainly mess everything up. Not least because when QDX receives a carriage return character, it will enter Terminal Applications mode; this will send all sorts of characters back to the PC (as QDX thinks it is now talking to a terminal emulator) and it will disable CAT command processing, so your PC digi modes software will not be able to talk to QDX. Disaster.

To fix this you need to issue the following commands to disable ModemManager:

```
sudo systemctl stop ModemManager
sudo systemctl disable ModemManager
sudo systemctl mask ModemManager
```

This will permanently stop ModemManager. If for some reason, you actually DO need ModemManager operational, for some other reason... well there IS a way to stop it just for QDX... but Google will be your elmer on this!

WSJT-X configuration

Next it is necessary to set up WSJT-X to communicate with QDX. We will use WSJT-X as the example, because it will be what most people are using. But other software will be identical (for example JS8Call) or similar. There are two parts to the set-up – firstly to choose the right USB Sound card, and secondly to set up the CAT communication so that WSJT-X can control the QDX via the serial comm port.

Open the WSJT-X settings window (from the File menu) and select the Audio tab. Select “QRP Labs QDX Transceiver” as the input and output sound card. The below screenshot shows how it looks on my system, which is Linux (Xubuntu 18.04). It will look different on Windows, Mac and perhaps other Linux distros but the basic idea will be the same... you should see something in the drop-down which says something about QDX, and that’s the sound card to select.

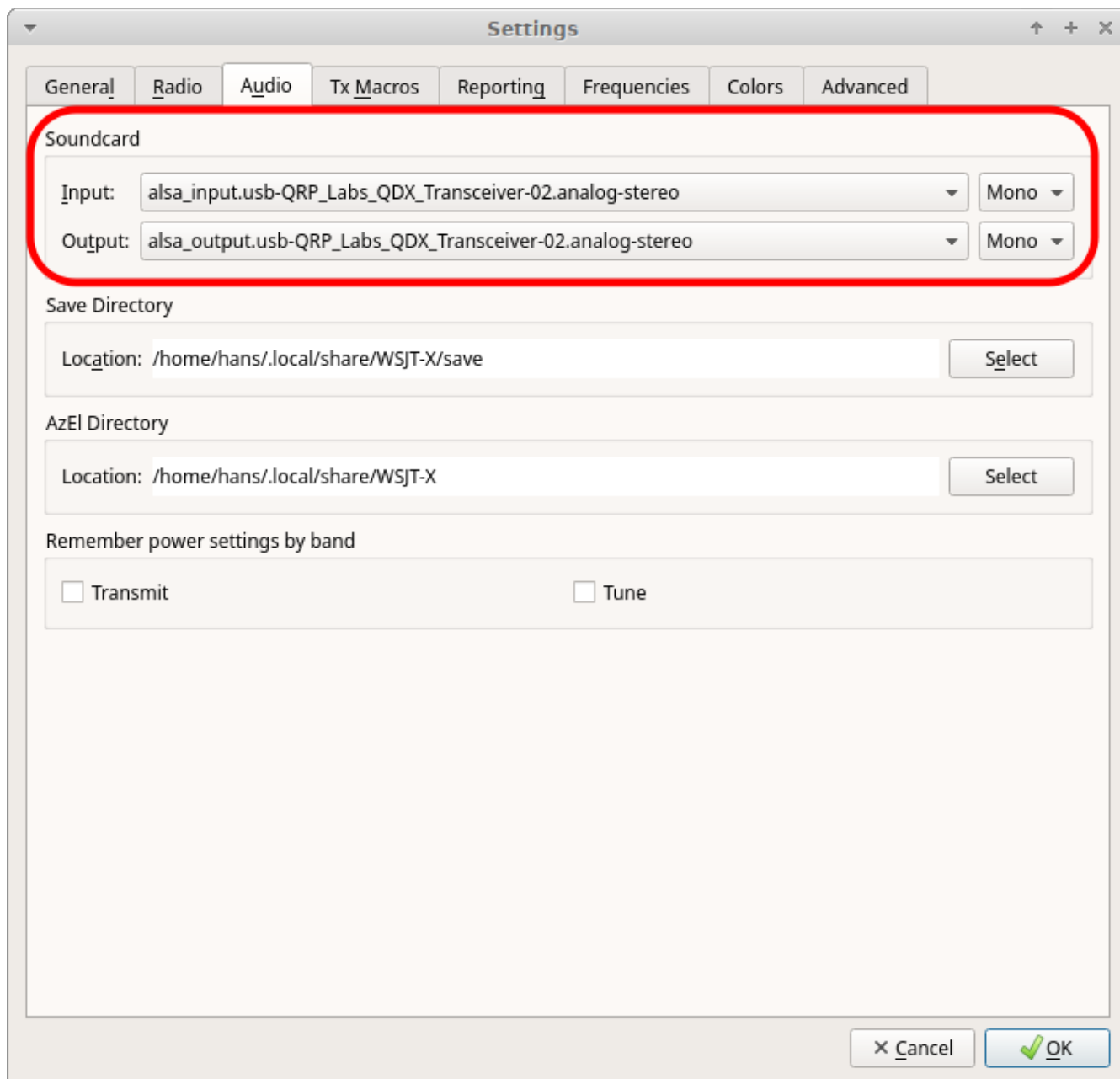

Next click the “Radio” tab in the settings window, which sets up the CAT control communication.

The following four settings need to be changed, and are illustrated in the diagram below:

- Rig will be set to None by default, click the drop down and choose “Kenwood TS-440” which should work well with QDX. On some other software, if you find that TS-440 is not present in the list or does not work properly, you could try “Kenwood TS-480”. More details about CAT and debugging any CAT problems are in another section of this manual, where the CAT test terminal screen is described.
- The Serial Port drop-down must be set to the correct port where QDX is connected. On my Linux system it is either “/dev/ttyACM0 or /dev/ttyACM1. On Windows systems it will be a COM port numbered COM1, COM2 etc. Unfortunately unlike the USB Sound, the serial port name doesn’t contain the text “QDX”. If you are unsure which port to choose for QDX, the easy way to find this is as follows. Unplug QDX. Restart WSJT-X. Look in Settings -> Radio and make a note of the list of serial devices. None of these are QDX (because you unplugged it). Now close WSJT-X, plug in QDX, start WSJT-X and again look in Settings -> Radio, and now you should see a newcomer in the list of available ports. The newcomer is QDX!
- Note that none of the Serial Port Parameters need to be changed, leave them all at their defaults. Even the baud rate 9600 is unimportant because it is irrelevant to the USB Virtual COM Port which is a virtual port over USB, not a real physical serial port.
- Change the Poll Interval to 10 seconds, the default will be rather chatty with QDX which probably is not a problem, but anyway I feel more comfortable with the less frequent polling. QDX has no capability to alter its operating frequency for example by itself, it can only do so at the command of WSJT-X over CAT; therefore the polling is actually redundant anyway.
- Change PTT Method from the default “VOX” to “CAT”. VOX means “voice operated exchange” or “voice activated transmission”; the radio will automatically switch to transmit, when incoming audio is detected. With PTT Method set to CAT, when WSJT-X wishes to start a transmission, it will send an actual CAT command to QDX informing it to start the transmission, before sending the audio. This CAT command causes QDX to switch from Receive mode to Transmit mode (and back again afterwards). “CAT” is preferable to “VOX” because if system sounds are accidentally routed to your “QDX” sound card as output, then with VOX that will enable the QDX transmitter and try to transmit the sound.
- Now click the “Test CAT” button and after a few seconds, it should turn Green to indicate successful communication with QDX.

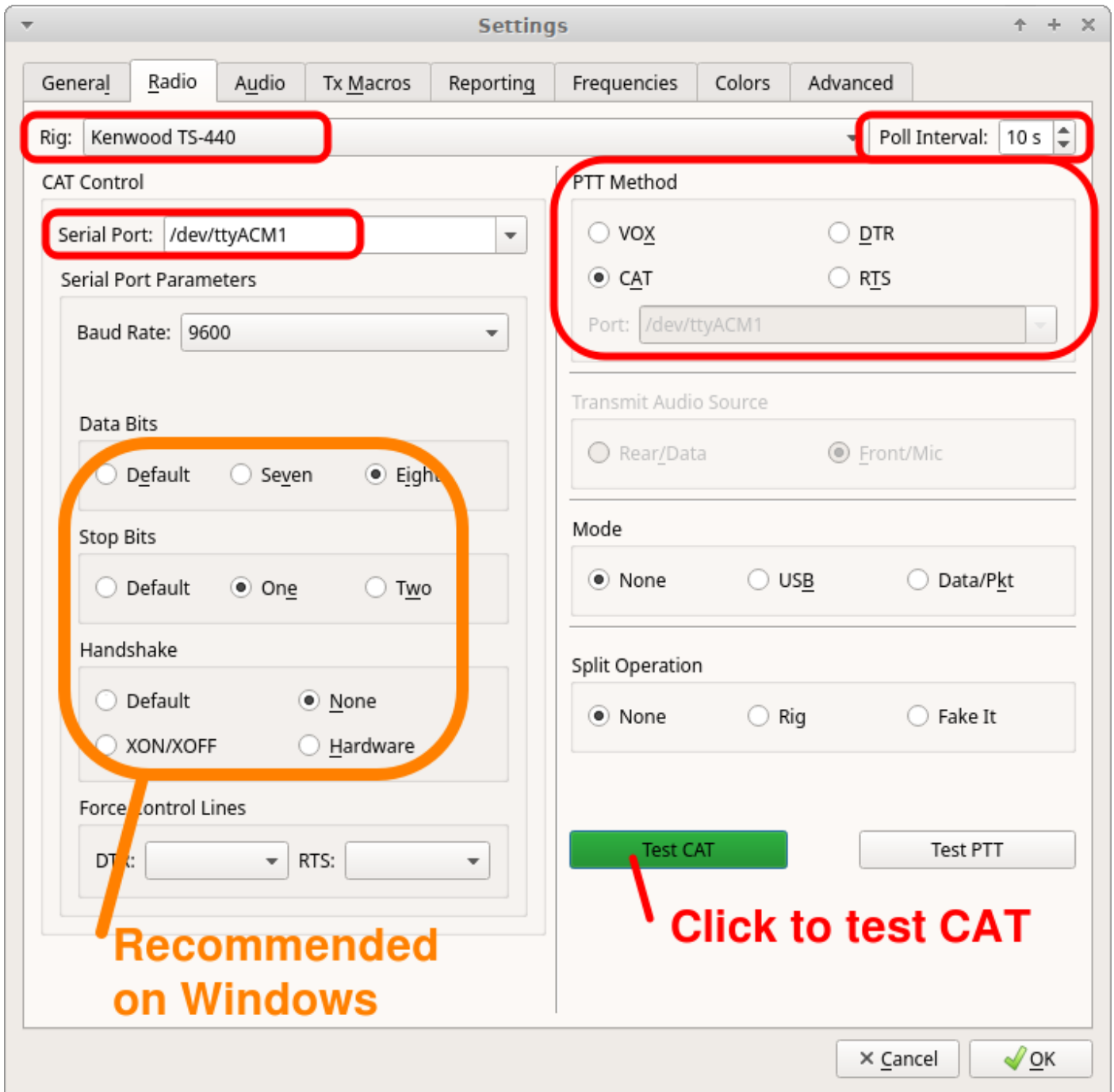

NOTE 1: If you are using other software than WSJT-X or JS8Call, then QDX CAT commands should still work with this software. If you encounter difficulties then it is possible that your software is trying to communicate with QDX using CAT commands that are not supported by QDX. In the section of this manual on the CAT Test utility (in the QDX Terminal applications), you will find a listing of the CAT commands supported by QDX. Another useful utility is the log file, which will let you record all CAT commands received and investigate any issues. If CAT commands are missing for your application, QRP Labs can add support for them easily.

NOTE 2: As mentioned above, CAT control of transmit/receive switching is recommended. If you INSIST on using VOX, QDX can support that. For example, you may be using a software application which does not support CAT control of transmit/receive switching and can only use VOX. In that case you should change the QDX transmit/receive switching mode from CAT to VOX in the QDX terminal Configuration utility, which is described in the terminal applications section of this manual.

NOTE 3: The Data Bits, Stop Bits, Handshake should not need to be changed; however several users have reported that changing them to the settings shown in the orange box has resolved some issues with CAT reliability on Windows Operating Systems.

WSJT-X “Pwr” Slider

The only other point to note is that WSJT-X should be operated with the power slider at the maximum setting. This point is discussed further in the QDX design section which explains that best accuracy in determining the audio tone frequency being sent by the PC, is when the Pwr is at the maximum setting. There is no point to using any setting other than maximum, because QDX only ever transmits at full power (5W), there is no way for it to transmit at a lower power output under command of WSJT-X. If you wanted a lower power output, you would need to use a lower supply voltage. Furthermore, QDX cannot be “over-driven” by too high volume, in the way that a SSB transceiver could.

Therefore the “Maximum” setting for the Pwr slider is highly recommended, it is the optimum setting for QDX operation.

The screenshot displays the WSJT-X v2.1.0 interface. The top section shows 'Band Activity' with columns for UTC, dB, DT, Freq, and Message. The right section shows 'Rx Frequency' with columns for UTC, dB, DT, Freq, and Message. A large red callout with the text 'Set Pwr slider to maximum' points to the 'Pwr' slider in the bottom right corner of the interface. The slider is currently set to the maximum value. The interface also shows a frequency display of 14.074 000, a date and time display of 2021 Sep 23 13:39:12, and various control buttons like 'Enable Tx', 'Halt Tx', and 'Tune'.

QDX Status LED

The front panel of QDX contains a 3mm red Status LED. The operation of this LED is as follows:

- Quick flashing (flickering) for first 5 seconds after power up: if you disconnect power now, then next time you power up, QDX will be in firmware update mode. During this five seconds QDX is also operating normally in Receive mode. After five seconds, the LED will go to a steady on (lit) state.
- Slow flashing: QDX is in firmware update mode (refer to the Firmware Update procedure section of this manual). If you did not wish to be in firmware update mode and have entered firmware update mode inadvertently, simply power down QDX and re-apply power; QDX will now be in normal operating mode again (quick flashing for the first five seconds, see above).
- Steady LED on state: QDX is in normal Receive mode operation
- LED flashes 3 times in quick succession, repeating every 1 second: QDX is in normal Transmit mode operation
- LED flashes 2 times in quick succession, repeating every 1 second: the PC host software application is sending audio to QDX, and QDX is detecting and measuring the incoming audio, however the volume is too low (refer to Troubleshooting section, below).
- LED flashes 1 time in quick succession, repeating every 1 second: the PC host software application has activated PTT but the QDX is not detecting any audio signal from the PC (refer to Troubleshooting section, below).

Operate!

Once CAT is configured and working, and the QDX sound card is chosen, just operate WSJT-X as you would normally! You can choose the desired band 80m, 40m, 30m or 20m from the WSJT-X screen and WSJT-X will communicate with QDX via CAT, to cause QDX to switch in the correct filters.

This QDX manual is not the place to include tutorials on various digi mode operation or particular application software such as WSJT-X, such guides are readily available and written very much more thoroughly than I could hope to achieve!

3 Firmware Update procedure

On occasion QRP Labs may make available updated firmware for QDX, in order to deliver bug fixes or functionality enhancements.

QDX contains a new firmware update procedure for STM32-series microcontrollers, called QFU (QRP Labs **F**irmware **U**ppdate) which provides the following features:

- **Easy** – anyone can do the firmware update
- **No additional hardware required:** only a standard USB A-B cable (or micro-USB cable if you have installed a micro-USB connector)
- **No additional software required:** just the standard file manager application that is already available on any PC
- **No drivers:** no special drivers need to be installed, the existing drivers on any modern PC operating system are used
- **Works on any PC Operating System:** and in the same way: Windows, Linux, Mac
- **Secure:** firmware files are published on the QRP Labs website and are encrypted using 256-bit AES encryption technology

Entering bootloader (firmware update) mode:

QDX provides two possible ways to enter firmware update mode:

- 1) On powering up QDX, you will see the QDX status LED flickers quickly for 5 seconds after power up, then illuminates solidly. If you power down QDX during this 5 seconds, then apply power again, QDX will now boot up in QFU (Firmware Update) mode.
- 2) Select the “Update firmware” menu option in the QDX Terminal (see subsequent section of this manual). QDX will then enter firmware update mode.

In firmware update mode, the status LED flashes slowly.

Exiting bootloader (firmware update) mode:

QDX provides two possible ways to exit firmware update mode:

- 1) Update the firmware! After updating the firmware, QDX will automatically reboot in normal operating mode.
- 2) Power down QDX, and re-apply the power again. QDX will reboot in normal operating mode.

USB Flash memory stick emulation:

In the firmware update mode, the QDX pretends to be a USB Flash memory stick, having a 4MByte capacity and implementing a FAT16 file system. This virtual “Flash stick” contains two files:

1. the firmware program file of the QDX microcontroller. You may read the file from QDX, or write a new one, just by dragging files in your file manager application.

- EEPROM contents: the QDX configuration and log file (if enabled). Again, you can read the file from QDX or write a new one to QDX, simply by dragging files in your file manager application.

On entering the Firmware update procedure, a pop-up window should appear on your PC. On my system (Linux XUbuntu 18.04) it looks like this:

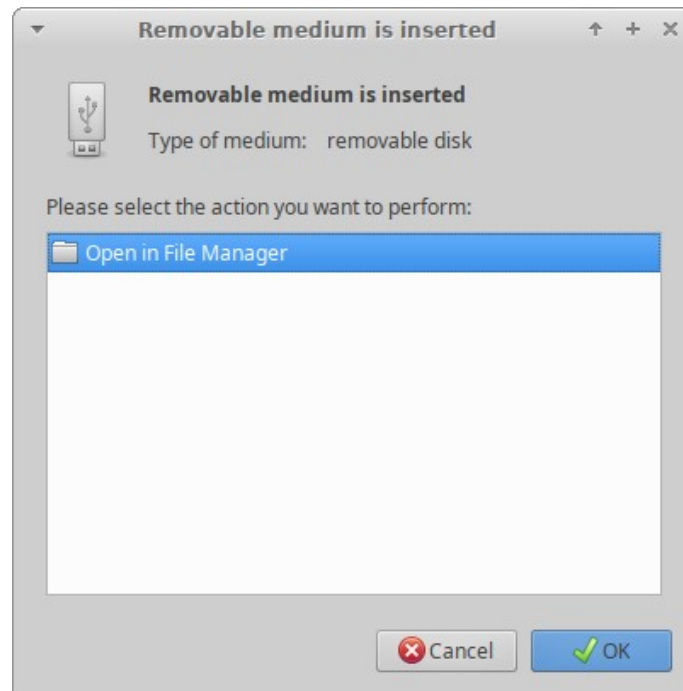

Click the OK button.

The File Manager window will then open, and on my system looks like this:

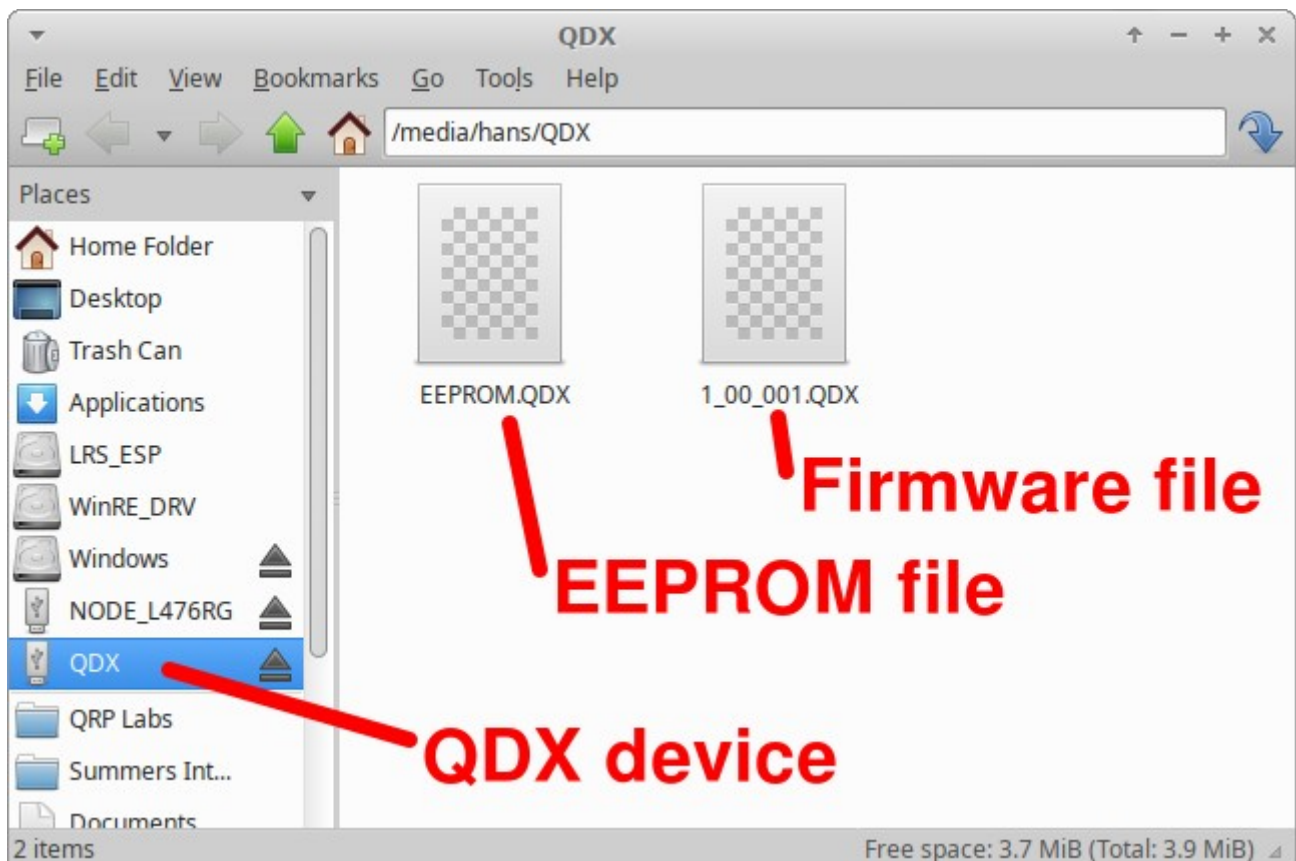

QDX appears as a removable USB Flash device named “QDX”, and the folder two files. The firmware file in this example is named shows a single file which is the firmware version file, 1_00_001.QDX in this example. The EEPROM file is always named EEPROM.QDX. You can read and write EEPROM files in order to make and restore backup copies of your configuration etc.

The firmware file name must not be longer than 8 characters, and cannot contain punctuation or spaces; the file extension must be no more than 3 characters. This is because the file system emulation is FAT16 and these are the specifications of the FAT16 format.

You may check the properties of the file and will note that it is a 119.5K file. QDX firmware images are always a 119.5K file. The creation date and modification date etc. have not been set, because it was important to minimize the size and complexity of the QFU bootloader, in order to maximize the space available to the application firmware.

You may copy the existing firmware file to another directory of your computer. Crucially, to do the firmware update, all you need to do is copy the new firmware file to this QDX “Flash disk”.

Download the new firmware file from the QRP Labs website, unzip it, and simply drag it into the folder where the existing firmware file version is shown. Or copy and paste it, however you wish.

The file on the QRP Labs website is a ZIPPED file, please be sure to unzip it to get the .QDX file before copying it to QDX.

As soon as you copy the new file to the QDX QFU “flash drive”, the QDX QFU bootloader erases the current program from its memory and installs the new one.

The QDX firmware is 256-bit AES encrypted and this means:

- The encrypted QDX firmware file will only work on a QRP Labs QDX board, it cannot be installed on any other board, even one containing the same processor.
- No other firmware file will work on the QRP Labs QDX board except an official QRP Labs encrypted QDX firmware file.

The procedure will vary slightly for different Operating systems but in all cases is just a simple matter of copying the new firmware file to the emulated QDX QFU USB Flash drive.

The above firmware update procedure works on ANY modern OS because the QFU bootloader emulates a USB Flash memory stick with the USB Mass Storage Device (MSD) class, for which drivers are already present.

The QFU bootloader implements a USB device stack (Mass Storage Device class), emulated FAT16 file system, Flash erase/write, and 256-AES encryption.

4 Terminal Applications

QDX provides a suite of applications which may be accessed via a Terminal emulator running on your PC. These applications provide configuration utility, and various self-test tools. It is very educational and interesting to experiment with these tools.

However, **most QDX users need never use the terminal applications, it is not necessary for ordinary operation of QDX with WSJT-X etc.** The terminal applications are for the interested user, or if you need to set up a particular configuration.

The terminal applications display everything as ASCII text in a 80 x 24 character window. It's not as polished as a dedicated graphical user interface software application for QDX would be. However, it has the advantage of requiring no special software or drivers, and all the variations that would have to be supported for different PC Operating Systems such as Mac, Windows and Linux, software installation procedures etc. Instead, all the applications are hosted and coded in the QDX itself. The terminal emulator is only used to display the results. This keeps things simple and low maintenance. After all, the terminal applications are useful bonus features rather than core QDX functionality.

4.1 PC terminal emulator

I use Linux (XUbuntu 18.04) and I'm using the PuTTY terminal emulator. There are numerous other terminal applications which will work fine. You may have your own favourite. They are all capable of correct operation with QDX in its terminal mode.

I start PuTTY using command line "sudo putty" then connect to QDX on /dev/ttyACM1. Again as before (refer to the Operating Instructions for connecting to QDX using CAT on WSJT-X) it is necessary to know which serial port is being used by QDX. There is also a guide to identifying the serial port at <http://qrp-labs.com/qlg2> (scroll down the page); or you could use WSJT-X.

Make sure WSJT-X is NOT running, when you connect to the QDX serial port using the terminal emulator. Only one PC application at a time can connect to Virtual COM Serial ports.

Set the size of the terminal window to 80 columns and 24 rows.

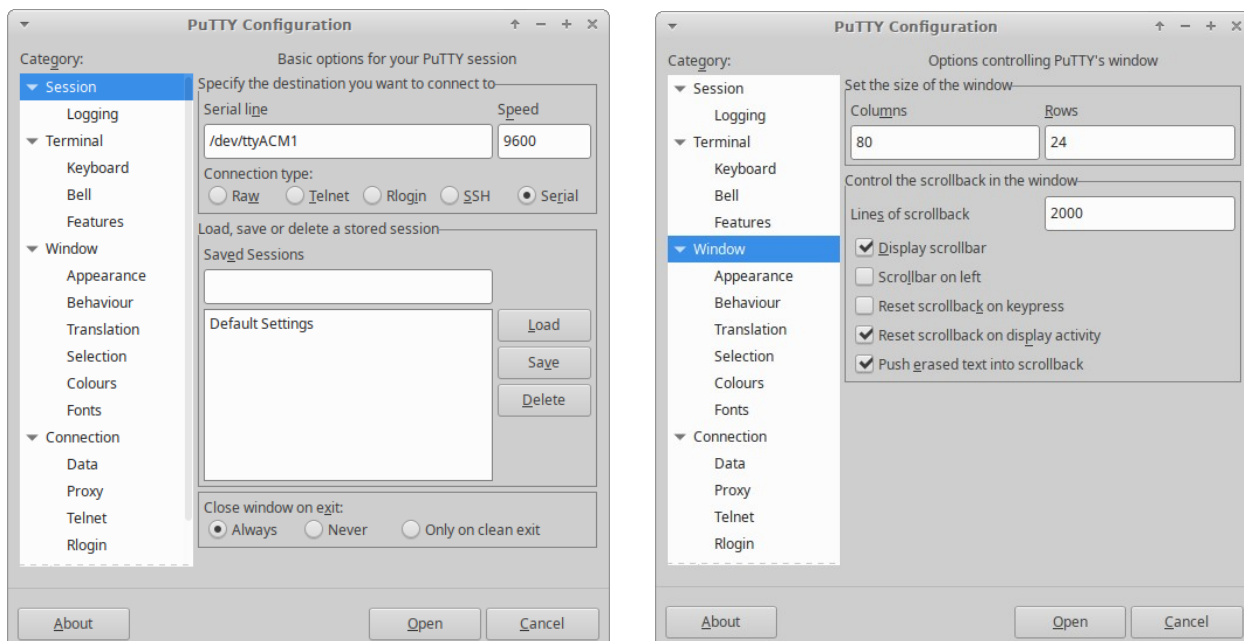

4.2 Entering terminal applications mode

Normally the QDX serial port is connected internally to the QDX's CAT command interpreter. CAT commands include text and numbers, each CAT command is terminated by a semicolon. CAT commands never include a carriage return (enter).

Note that when the terminal is connected, you can actually type on your keyboard to send CAT commands. For example, try typing FA; (just those three characters – no Enter at the end). The text FA00007074000; will appear on the terminal. FA is the command to read or set VFO A, and the result is 7.074 kHz, the default QDX startup frequency. HOWEVER, this is not a very convenient or easy way to try out CAT commands, there is a CAT command testing application which is much easier to use.

To switch to terminal applications mode, simply press the Enter key on your keyboard. Now the terminal applications mode will appear in your terminal emulator window, as shown below. The screen shows the QDX firmware version (coloured yellow at top left), and a list of applications coloured white. You may use the cursor keys to move the highlighted application up and down in the list, and press Enter to select an application. Any application can be quit by pressing Ctrl-Q which returns the terminal to the main menu screen.

Operation of each of the applications will be described in detail in subsequent sections.

```
QDX v1_05
QRP Labs, 2022
```

Configuration

```
Band configuration
Audio filter sweep
RF filter sweep
Image sweep
Input analysis
CAT command test
CAT monitor
Log file
Transmitter test
Factory reset
Update firmware
Exit terminal
```

4.3 Exiting terminal applications mode

When exiting terminal applications mode, do not simply close the terminal emulator window. Doing so will leave the QDX in terminal applications mode and it will not accept CAT commands. To switch it back to CAT command mode, use the cursor keys to scroll down to the "Exit terminal" option at the bottom of the list, and press Enter. The screen is now cleared, and QDX is back in CAT command mode. Only then should you close the terminal emulator window.

4.4 Configuration

```
QDX v1_05
QRP Labs, 2022

Configuration
Band configuration
Audio filter sweep
RF filter sweep
Image sweep
Input analysis
CAT command test
CAT monitor
Log file
Transmitter test
Factory reset
Update firmware
Exit terminal

+--- Configuration ---+
|
| TCXO frequency          25000000
| Sideband                USB
| Default frequency      7074000
| VOX                     DISABLE
| Rise threshold         80
| Fall threshold         60
| Minimum cycles         1
| Minimum samples        480
| Discard cycles         1
| IQ mode                 DISABLE
| Japanese band limits   DISABLE
| CAT timeout enable     ENABLE
| CAT timeout (sec)      120
| PTT Port as Serial 3   DISABLE
| VGA PS/2 terminal       DISABLE
| Serial 1 terminal       0
| Serial 2 terminal       0
| Serial 3 terminal       0
|
+--- Ctrl-Q = Quit ---+
```

The configuration screen allows entry of various QDX configuration parameters. The default values are suitable for the vast majority of operating use. The following paragraphs describe each configuration setting in turn. Use the up/down arrows to select the item you wish to edit. The cursor is positioned at the last character of the value. Numeric values have a defined field length. You can press the backspace key to delete the current entry in whole or in part, and type in the new value. For non-numeric configuration parameters, you can use the left and right arrow keys to choose between the available values.

TCXO Frequency

Default is 25000000 (25 MHz). This is the oscillation frequency of the QDX TCXO (Temperature Controlled Crystal Oscillator) and is used for calculating Si5351A parameters for setting the desired QDX operating frequency.

The supplied TCXO is a high precision component and will normally be found to be within (a one standard deviation error of) +/- 5 Hz of the specified 25 MHz value. It is not normally particularly necessary from an operating perspective, to have a more precise operating frequency than this. Remember that the error is also scaled to the operating frequency. So a 5 Hz error at 25 MHz will translate to a 2.8 Hz error at 14 MHz.

However the perfectionists among you may wish to calibrate your operating frequency precisely – and this menu entry is for you!

To configure the correct TCXO reference frequency, you will need to measure your operating frequency, deduce the error amount, and apply a correction to the TCXO frequency configuration parameter.

As an example, suppose your transceiver is set to a USB “Dial Frequency” of 14.0956 MHz and WSJT-X is set up to transmit WSPR at 1500 Hz audio offset. This should result in a transmission frequency of 14.097100 MHz. But let’s suppose that you measure it accurately, and you find that it is 3 Hz high, at 14.097103 MHz. Now what?

There’s an error of +3 Hz in your operating frequency. To work out the required correction to the TCXO reference frequency configuration, calculate 3 Hz multiplied by a ratio of 25 MHz / 14.0971 MHz, which results in 3 Hz x 1.77 = 5.3 Hz.

Therefore you should increase the reference frequency by 5Hz. So move the highlight to the TCXO frequency using the up/down cursor keys, then press the backspace key once, and type 5. That will change the reference frequency to 25000005.

How about if you don’t have an accurate way of measuring your operating frequency? I have developed tools for QRP Labs website to help you to use the WSPRnet reporting network to determine your operating frequency quite accurately. To use these tools, simply use WSJT-X and QDX to operate as a 20m WSPR reporter (receiver) for several minutes, then look at this page:

<https://qrp-labs.com/images/wsprnet/rxerror.html>

Look for your callsign in the list, which shows the error in your reception reports (operating frequency error).

Alternatively, you may operate as a WSPR transmitter using WSJT-X and QDX, and the following page will show your actual transmitting frequency:

<https://qrp-labs.com/images/wsprnet/txfreq.html>

Both of these QRP Labs pages are updated every two minutes. The analysis loads the last 5 minutes (approximately) of 20m WSPR reports from the WSPRnet website database. It cross-references all the reports, analyzing the error of receiver stations by cross-referencing against reports of the same transmitters by other stations. In this way calibration errors of all receiving stations in the network are averaged out. The accuracy is generally within 1 or 2 Hz.

Sideband

This setting determines the demodulation sideband. Normally Upper Sideband (USB) is used for all digital modes, and is the default setting. If you wish to use Lower Sideband (LSB) for some reason, you can change it here. Use the left and right arrow keys to change between LSB and USB.

Default frequency

This is the default start-up frequency of QDX at power-on. It defaults to the 40m FT8 frequency 7.074 MHz. If you would like it to power up on a different frequency, you may edit this configuration setting.

VOX

If you want to use VOX (Voice Operated Transmission) then set this parameter to ENABLE. Any incoming audio from the PC will then operate the Transmit/Receive switch and be transmitted. When the audio stops, QDX will switch back to Receive automatically. The problem with this is that any system sounds on your PC, if the PC is configured to deliver these to the QDX USB sound card, will operate the transmitter and be transmitted.

The default setting “DISABLE” requires a CAT command from the PC host application (WSJT-X for example) in order to enable the transmitter. This is discussed in this manual in the operating manual section, on setting up WSJT-X for QDX.

If you wish to use software that does not support CAT Transmit/Receive switching, this may be one reason why you would want to enable VOX.

If using VOX, you will also need to disable the CAT timeout feature (see below).

Rise threshold

This is a percentage signal level of maximum, above which the transmitter will be keyed down (switched on). Its purpose is to ignore very low amplitude audio signals at the start of a raised cosine keying envelope, whose audio tone could be decoded inaccurately due to quantization error. This is discussed further in the Design section of this manual in the Audio Frequency Analysis section. The default value of 80% should be fine for all purposes. The value should not be set too close to 99%, since higher frequency audio where the number of samples per cycle is small, may not contain a value sufficient to trigger this threshold in every cycle.

Fall threshold

This is a percentage signal level of maximum, below which the transmitter will be keyed up (switched off). Its purpose is to ignore very low amplitude audio signals at the end of a raised cosine keying envelope, whose audio tone could be decoded inaccurately due to quantization error. This is discussed further in the Design section of this manual in the Audio Frequency Analysis section. The default value of 60% should be fine for all purposes. The value should not exceed (or be close to) the Rise threshold parameter, otherwise the transmitter will be repeatedly keyed on and off falsely.

Minimum cycles

This parameter specifies the minimum number of audio cycles to use, in the measurement of audio cycle period, for audio frequency calculation. This parameter is used in conjunction with the Minimum samples parameter: both conditions must be satisfied in order for an audio frequency measurement to be completed. This parameter is discussed further in the Design section of this manual in the Audio Frequency Analysis section. The default value of 1 should be fine for all purposes.

Minimum samples

This parameter specifies the minimum number of audio samples to use, in the measurement of audio cycle period, for audio frequency calculation. This parameter is used in conjunction with the

Minimum samples parameter: both conditions must be satisfied in order for an audio frequency measurement to be completed. This parameter is discussed further in the Design section of this manual in the Audio Frequency Analysis section. The default value of 480 should be fine for all purposes.

Bearing in mind that there are 48,000 audio samples per second, a value of 480 specifies a minimum 0.01 second audio measurement period. In other words, there will be 100 measurements of the audio frequency, per second, in this default configuration. This is sufficient to ensure that high audio frequencies are measured accurately. In the unlikely event that frequencies below 100Hz need to be measured, the “Minimum cycles” value (1) will ensure that a longer measurement period is used, to measure one cycle.

Discard cycles

This parameter specifies the number of audio cycles (zero crossings) which are ignored, when audio is first detected. The reason for this parameter is that in conjunction with the “Rise threshold” parameter, it can be seen that the first audio cycle after the threshold is passed, is not a complete cycle. The following zero crossing therefore needs to be discarded because its period measurement will be too short. The default value of 1 should be fine for all purposes.

IQ Mode

When IQ mode is enabled, the raw I and Q channels from the ADC are fed to the USB soundcard directly, without any demodulation. This is suitable for people wishing to experiment with using QDX as an SDR front end, with PC SDR software to demodulate I and Q channels.

IQ Mode is not suitable for use with WSJT-X and other Digi mode programs.

Japanese band limits

When this setting is enabled, QDX will refuse to go into transmit mode if the specified synthesis frequency is outside the Japanese band limits as specified in the JARL bandplans document https://www.jarl.org/English/6_Band_Plan/JapaneseAmateurBandplans20200421.pdf. This setting is useful for Japanese license regulations compliance.

CAT timeout enable

When this setting is enabled, which it is by default, there is a timeout on Transmit; if the timeout elapses and QDX does not receive a CAT command requesting it to switch back to Receive, then it will automatically switch back to Receive.

This feature needs to be disabled if using VOX.

CAT timeout (sec)

The duration of the CAT command timeout (see above), in seconds.

PTT Port as Serial 3

Enabling this parameter changes the behaviour of the 3.5mm PTT jack on PCB Rev 3 and above. This jack becomes an additional serial port.

This requires a HARDWARE change to remove and bypass the transistors driving the PTT signals. The port is then a 3.3V logic (5V logic tolerant) serial port with configurable baud rate. These changes are as described in the schematic below. Remove Q12 and Q13 completely, along with R5 and R42. Jumper between the gate and drain of each of the transistors.

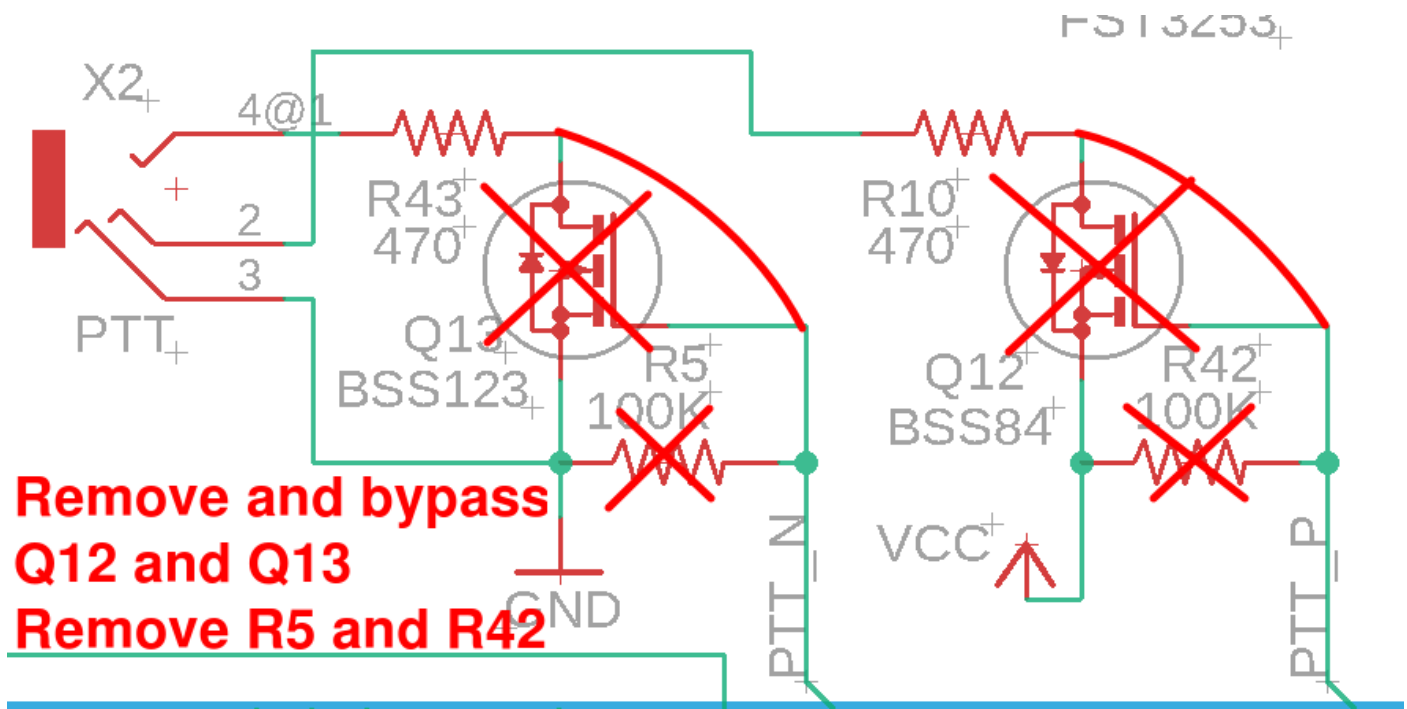

Serial 1 terminal

Specifies the baud rate of serial terminal 1. To disable serial terminal 1, leave the parameter at zero.

Serial 2 terminal

Specifies the baud rate of serial terminal 2. To disable serial terminal 2, leave the parameter at zero.

Serial 3 terminal

Specifies the baud rate of serial terminal 3. To disable serial terminal 3, leave the parameter at zero. Serial terminal 3 can only be used if the “PTT Port as Serial 3” setting is set to ENABLE (see above).

Use of the additional serial ports

These additional three serial ports can all be used alongside the existing Virtual COM Serial port and interchangeably with it. This can be useful if you want to access the configuration settings at

the same time as use the main Virtual COM serial port for CAT control by WSJT-X (etc) software on the host PC.

The ports are standard serial connections, with configurable baud rate. To use them with USB requires a USB to Serial converter. One option is to use the USB to Serial converter onboard the QRP Labs QLG2 GPS Receiver module.

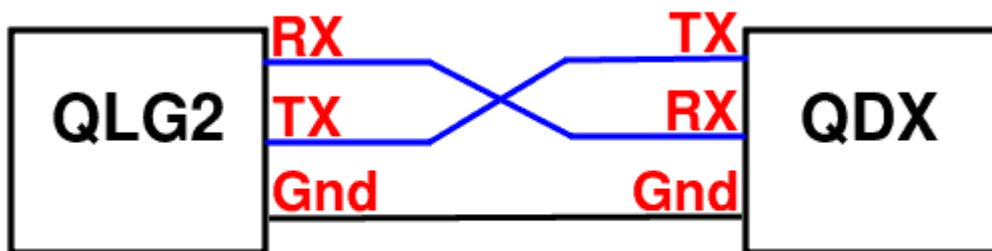

Remember RX/TX signals cross!

The correct jumper configuration on the QLG2 board for this is shown below; then the RX and TX signals are connected at the row of 6 pads labeled PH2 at the bottom of the board (to GND, TXD and RXD).

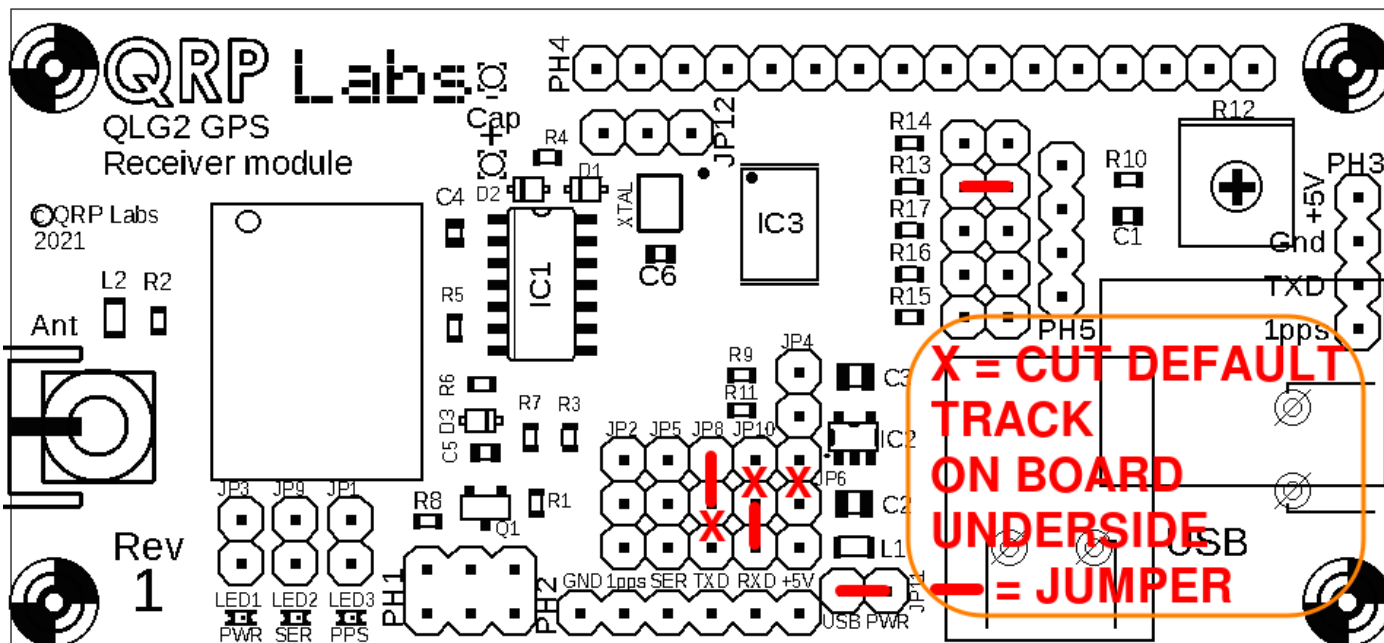

Connection of serial ports 1 and 2 (and also 3 if you have a pre-Rev 3 PCB) requires soldering wires directly to the microcontroller pins, a task to be undertaken with considerable care, to say the least.

The various possible connections are described in the following diagram:

Underside of PCB

BOARD EDGE

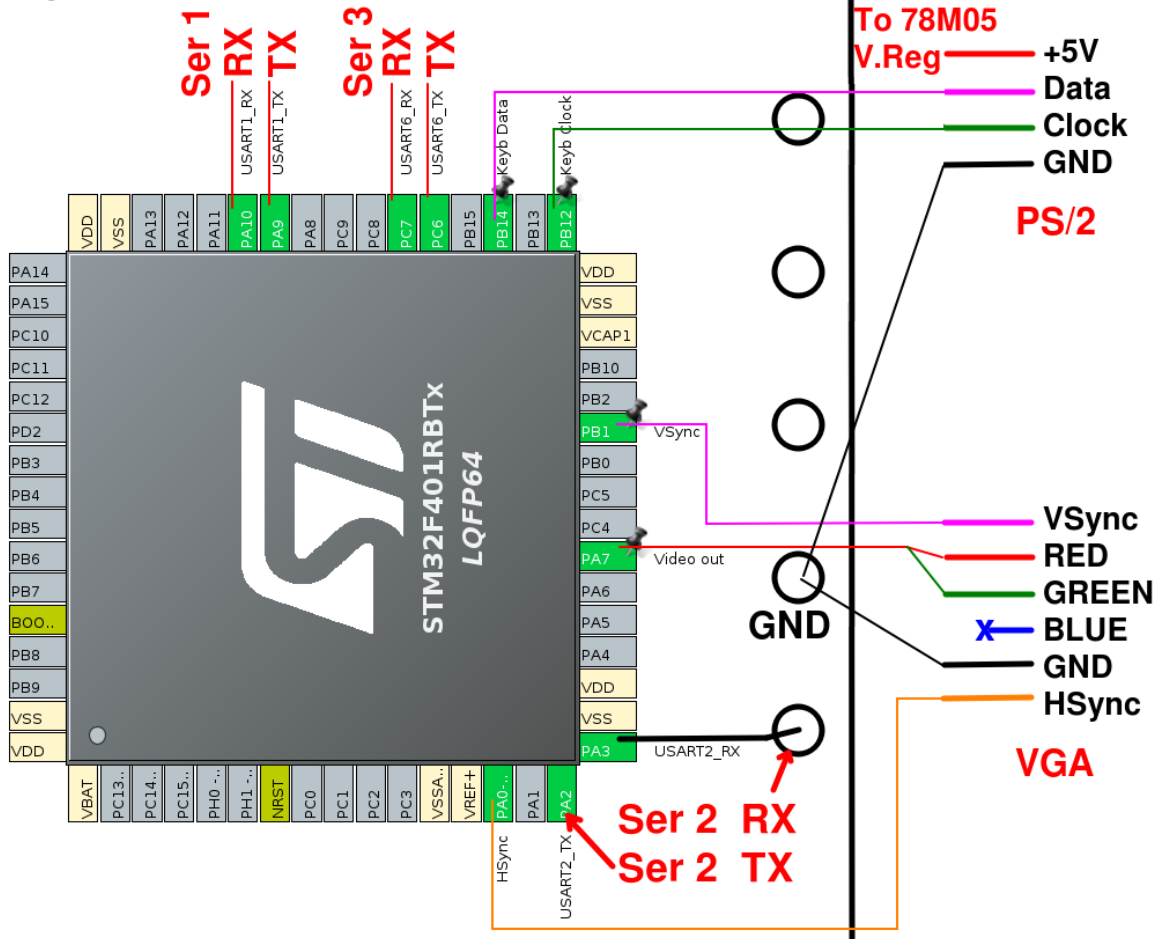

You may note that firmware 1_05 also has the possibility of a monochromatic VGA output and PS/2 keyboard connection. The VGA signal is generated directly on microcontroller pins by firmware. It implements 800 x 600 pixel, 56fps SVGA mode. Due to RAM constraints on the microcontroller, it actually sends each scanline twice, so effectively it is 800 x 300 pixels. The code implements an 80 x 25 character sort-of-VT220 type of terminal feel, using a character font on a specially designed 10 x 12 pixel font.

The classic "amber" type display colouring is attained by driving red and green monitor inputs in parallel (which would give yellow), then using the monitor's own colour adjustment menu to reduce the green contribution to around 70-75% according to taste, which produces the amber-ish colour tone.

So there are FIVE possible serial terminals: the classic

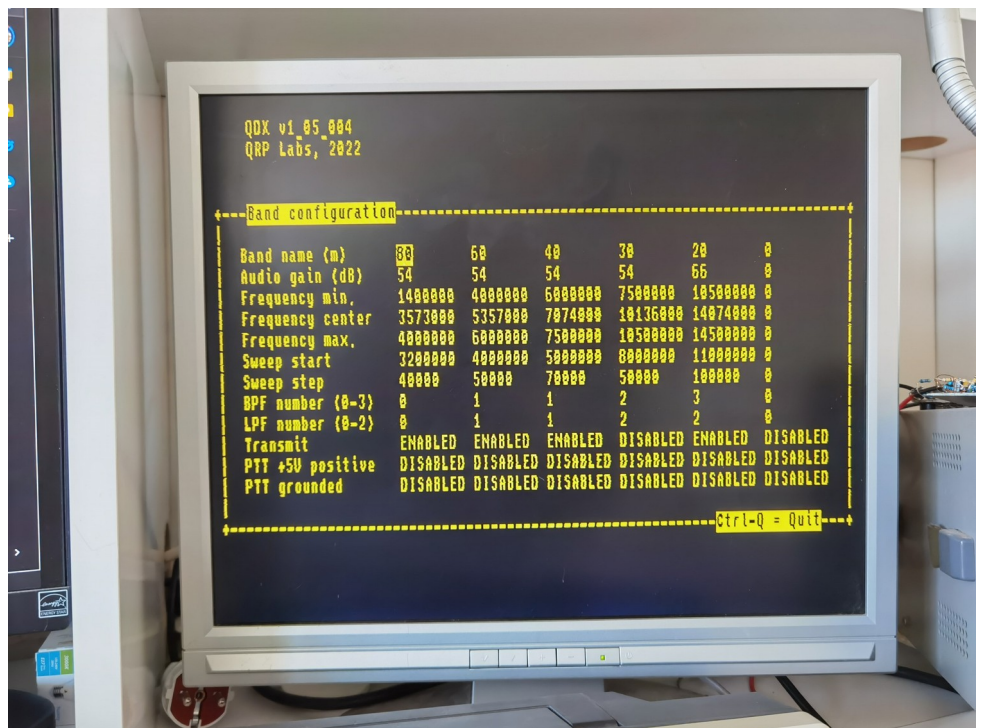

USB Virtual COM Serial connection, three additional serial ports, and the built-in VGA and PS/2 interfaces for the board.

If more than one terminal is connected, access to the various terminal applications is in most cases limited to only one terminal; when a different terminal accesses a particular application, it goes red on other terminals to indicate that it cannot be opened (on the VT220 which is monochrome and so doesn't have "red", disabled applications are enclosed in parenthesis).

For fun, there's also a secret "Easter egg" in the code, which you can access by pressing the M key at the main menu (on the PS/2 keyboard terminal only), which draws the Mandelbrot set on the VGA output.



The VGA terminal during development:

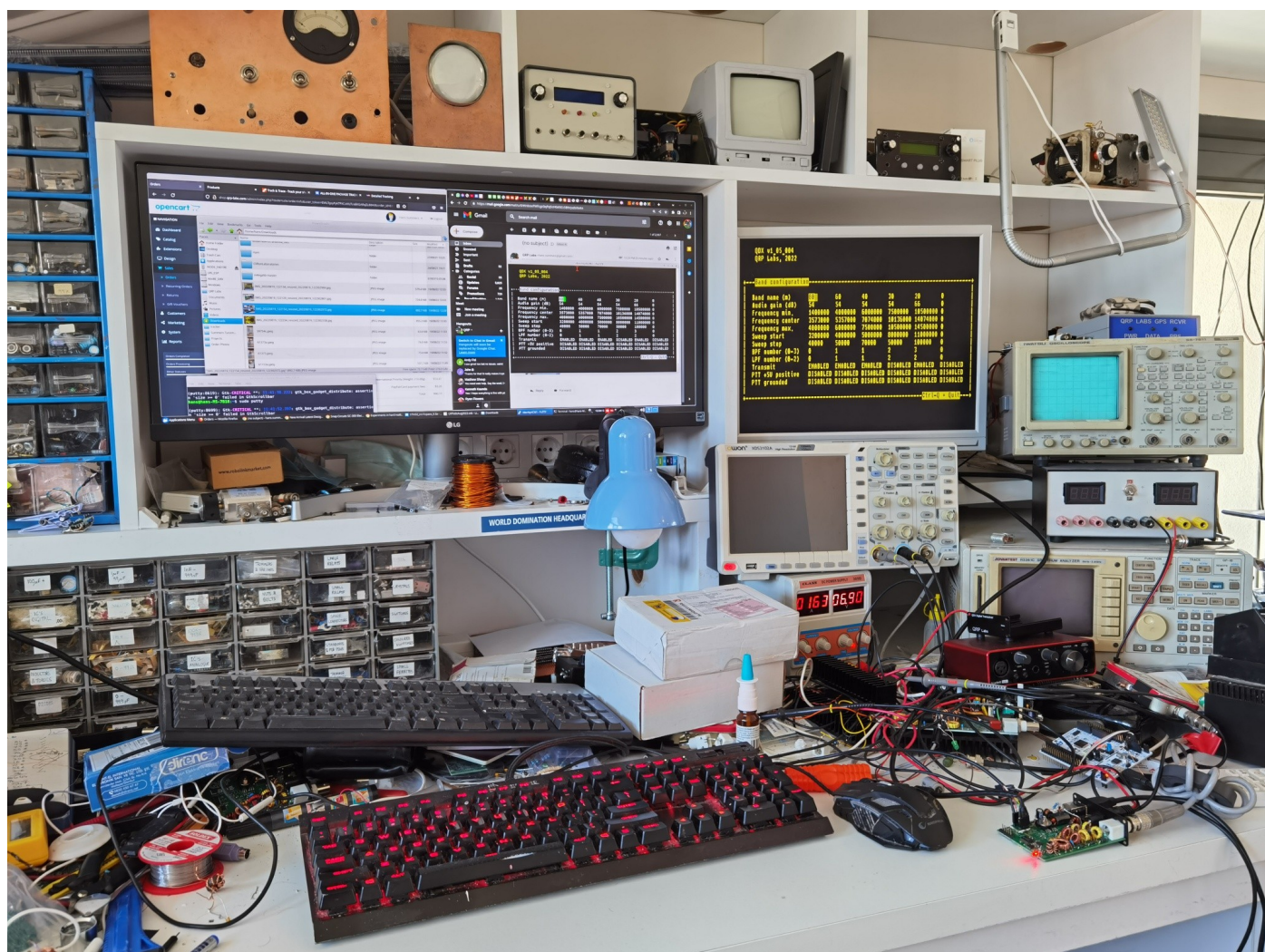

4.5 Band configuration

```
QDX v1_05
QRP Labs, 2022

+---Band configuration-----+
|
| Band name (m)      80      60      40      30      20      0
| Audio gain (dB)   54      54      54      54      54      0
| Frequency min.    1400000  4000000  6000000  7500000  10500000  0
| Frequency center  3573000  5357000  7074000  10136000 14074000  0
| Frequency max.    4000000  6000000  7500000  10500000 14500000  0
| Sweep start       3200000  4000000  5000000  8000000  11000000  0
| Sweep step        20000    50000    50000    50000    100000    0
| BPF number (0-3)  0         1         1         2         3         0
| LPF number (0-2)  0         1         1         2         2         0
| PIN fwd bias (mA) 30         30        30        30        30        30
| Transmit          ENABLED   ENABLED   ENABLED   ENABLED   ENABLED   DISABLED
| TX PTT +5V        DISABLED  DISABLED  DISABLED  DISABLED  DISABLED  DISABLED
| TX PTT grounded   DISABLED  DISABLED  DISABLED  DISABLED  DISABLED  DISABLED
| RX PTT +5V        DISABLED  DISABLED  DISABLED  DISABLED  DISABLED  DISABLED
| RX PTT grounded   DISABLED  DISABLED  DISABLED  DISABLED  DISABLED  DISABLED
|
|-----Ctrl-Q = Quit-----+
```

The Band Configuration screen allows specification of all parameters that are handled per-band. This screen is populated by default with the correct information to set QDX up for 5-band operation on 80, 60, 40, 30 and 20m. However, if you wish to experiment with other bands (which will require hardware modifications to Receiver Band Pass Filter and Transmitter Low Pass Filter component values – for which you are on your own), then you may specify the other band parameters here.

There is space for 6 band configurations, which are arranged in columns in a table. You may move from one column to the next by using the left/right arrow keys. Use the up/down arrow keys to move up and down the rows of each band specification column.

Note that for 160m and 630m operation, the QDX uses a different technique to generate 90-degree quadrature oscillator signals on reception. For a period of 20ms the two clock signals are set to a slightly different frequency (12.5Hz apart) such that after 20ms the clocks have exactly 90-degree phase shift; then they are set again to the exact same frequency, and the 90-degree phase difference is maintained. To trigger this operation, the band name must be set to 160, 600 or 630.

Remember that the number of characters in each setting is limited. To change the parameter setting, you generally need to press the Delete key in order to delete the existing setting characters, then enter new ones. The setting is stored in memory when you press the Enter key, or one of the arrow keys to move to a different cell of the table.

As usual, press Ctrl-Q to quit the Band Configuration utility.

An explanation of the items in the Band Configuration screen follows:

Band name (m): The name of the band - this appears in all the other terminal applications such as RF sweep, Transmitter test etc. to identify the set of settings corresponding to the band. The name also determines certain behaviour, as follows.

For operation below 3MHz – which is given by 25MHz (ref freq) x 15 (minimum PLL multiplier) divided by 126 (maximum phase offset register value), Si5351A quadrature output on Clk0/Clk1 has to be generated by a different method. Setting the phase offset register equal to the MultiSynth divider does not work, because the phase offset register is only 7 bits. An alternative method is used, as in the QCX-series transceiver operation on 160m. Specifically, when entering a band below 3MHz, two clocks are set to be initially in phase, but 12.5Hz apart. 20 milliseconds later, they are set back to the same frequency; by this time they have drifted 90-degrees apart, which is the desired phase offset and is maintained during further frequency changes that affect only the PLL multiplier.

This behaviour for bands under 3MHz is triggered by the Band name parameter being one of 630, 600 or 160m. QDX operation therefore works for the two bands 630/600m and 160m.

Additionally, when the band name is within the set {630, 600, 160, 80, 60, 40, 30, 20} the MultiSynth divider is fixed, according to this table:

<u>Band name</u>	<u>MS Divider</u>
630	1280
600	1280
160	320
80	126
60	126
40	126
30	84
20	64

For any other band name, the MS divider is chosen to be the next even integer below 600 / Band name. For example, for 21.078MHz operation, the divider would be $600 / 21.078 = 28.47$ MHz, and the next even integer below that is 28. Therefore the divider 28 is used.

Audio gain (dB): 54 is the default and corresponds to the default value of 5,000 used in earlier firmware versions in the main configuration screen. Valid values for the parameter are 0 to 99. This makes it easy to choose a gain by band - which is often useful to get WSJT-X and JS8Call perfectly happy on each band without needing to manually fiddle with gain adjustments when changing bands. WSJT-X and JS8Call documentation recommends when the band is empty, the signal strength meter on the bottom left should be at about +30dB.

Frequency min.: When you command a new frequency via CAT (from WJST-X etc), this is the lower limit of this band definition.

Frequency center: The center frequency, which is the frequency of the vertical blue line seen in the RF sweeps, the test frequency for AF sweeps, and is the frequency used by the Transmitter Test screen. It doesn't have any other purpose and doesn't have to be the actual center (half way between min and max).

Frequency max.: When you command a new frequency via CAT (from WSJT-X etc), this is the upper limit of this band definition .

Sweep start: the start frequency for the RF sweep screen. Note that the minimum measurable frequency is $375 / \text{MS Divider}$ (see Band name section above, for details on MS Divider). If the

sweep starts on a non-measurable frequency, the actual graph line will not start until a measurable frequency occurs.

Sweep step: the step frequency for each point of the RF sweep plot screen. Similarly to the above (Sweep start), the maximum measurable frequency is $1150 / \text{MS Divider}$ and points above this are not plotted on the graph.

BPF number (0-3): The Band Pass Frequency selection for this band.

LPF number (0-2): the Low Pass Frequency selection for this band.

PIN fwd bias (mA): Specifies the forward current, in mA, to be driven through each of the two PIN diode switches either side of the Low Pass Filter during transmit. The adjustment range is 5 to 60mA. The default value is 30mA and should generally be left alone.

Transmit: Enabled or Disabled, to allow or prevent transmission on this band. Press the E key to enable, D key to disable.

TX PTT +5V: To enable or enable, for this band, whether +5V appears on the PTT connector "ring" connection during transmit. Press the E key to enable, D key to disable.

This output is designed to directly interface with the QCX-series 50W Power Amplifier with a simple stereo jack audio cable. Remember, the 50W PA is a SINGLE BAND amplifier so should only be used on the QDX with a single band, unless you are going to build an external switched Low Pass Filter. Also remember that the 50W QCX-series amplifier is designed for CW operation and not suitable for the high duty cycle of digital modes; therefore if you wish to use this with the QDX transceiver, be sure to limit it to around 20-25W output power; this will be achieved by using a 12V supply voltage to the 50W PA kit.

TX PTT grounded: To enable or disable, for this band, whether the PTT "tip" connection is grounded during transmit. Press the E key to enable, D key to disable. This PTT output is suitable for driving a typical grounded PTT type amplifier.

Please refer also to the hardware documentation (assembly manual) for more information on the PTT connection, and the circuits driving it.

The PTT connector is a 3.5mm stereo jack connector. The "ring" connection can be configured as a +5V PTT output, suitable for switching the QCX-series 50W amplifier. The "ring" connection is also used on the 50W PA so only a standard stereo audio jack cable is required. The "tip" connection can be configured as a grounding PTT output for connection to most other amplifiers.

Both the +5V-going and grounded PTT outputs ("ring" and "tip" connections respectively) are MOSFET open-drain outputs (utilizing P-channel and N-channel type MOSFETs respectively). Both outputs have a 470-ohm resistor in series to protect them against accidental damage for example, shorts to ground.

RX PTT +5V: To enable or enable, for this band, whether +5V appears on the PTT connector "ring" connection during receive. Press the E key to enable, D key to disable. Generally for use with an external PA, these settings should all be left DISABLED. However if you wish use the +5V output for some auxiliary control purpose such as a relay for external switching of antennas, then you can configure it to be active during Receive as well as transmit.

RX PTT grounded: To enable or disable, for this band, whether the PTT "tip" connection is grounded during receive. Press the E key to enable, D key to disable. Generally for use with an external PA, these settings should all be left DISABLED. However if you wish use the grounded output for some auxiliary control purpose such as a relay for external switching of antennas, then you can configure it to be active during Receive as well as transmit.

4.6 Audio filter sweep

QDX contains its own internal signal generator, which can be used to sweep the audio passband of the receiver, checking the audio response and the unwanted sideband cancellation.

Connect a dummy load for best results.

On entering the application, a sweep automatically commences. The percentage completion of the frequency sweep is indicated in the bottom right corner of the screen.

The sweep starts at 100 Hz (injected signal is 100 Hz higher than the “USB Dial Frequency”, then proceeds in 50 Hz steps up to and including 3850 Hz. The RF frequencies (“USB Dial Frequency”) used for bands are defined in the Band Configuration screen of the QDX. For example, for 80, 40, 30 and 20m are 3.573, 7.074, 10.136 and 14.074 MHz respectively. The vertical axis shows audio decibel (dB) level. The offset is arbitrary. Gridlines axis are displayed in blue. Vertical gridlines are every 20dB, and horizontal axis gridlines every 1000 Hz. Gridline labels are displayed in blue; the minimum and maximum audio level (in dB) displayed in white, and the maximum audio sweep value also displayed in white.

The chart contains two lines, the line of yellow asterisks is the Upper Sideband (USB) and the red line is Lower Sideband (LSB). In the default demodulation mode (USB), we expect to see the yellow line nice and flat between the filter cut-off points 150 Hz to 3.2 kHz. The red line is the unwanted sideband and we expect to see it around 60dB below the wanted sideband.

The – and + keys can be pressed to move down and up to adjacent bands defined in the Band Configuration screen. Generally the result should not differ much from one band to the next.

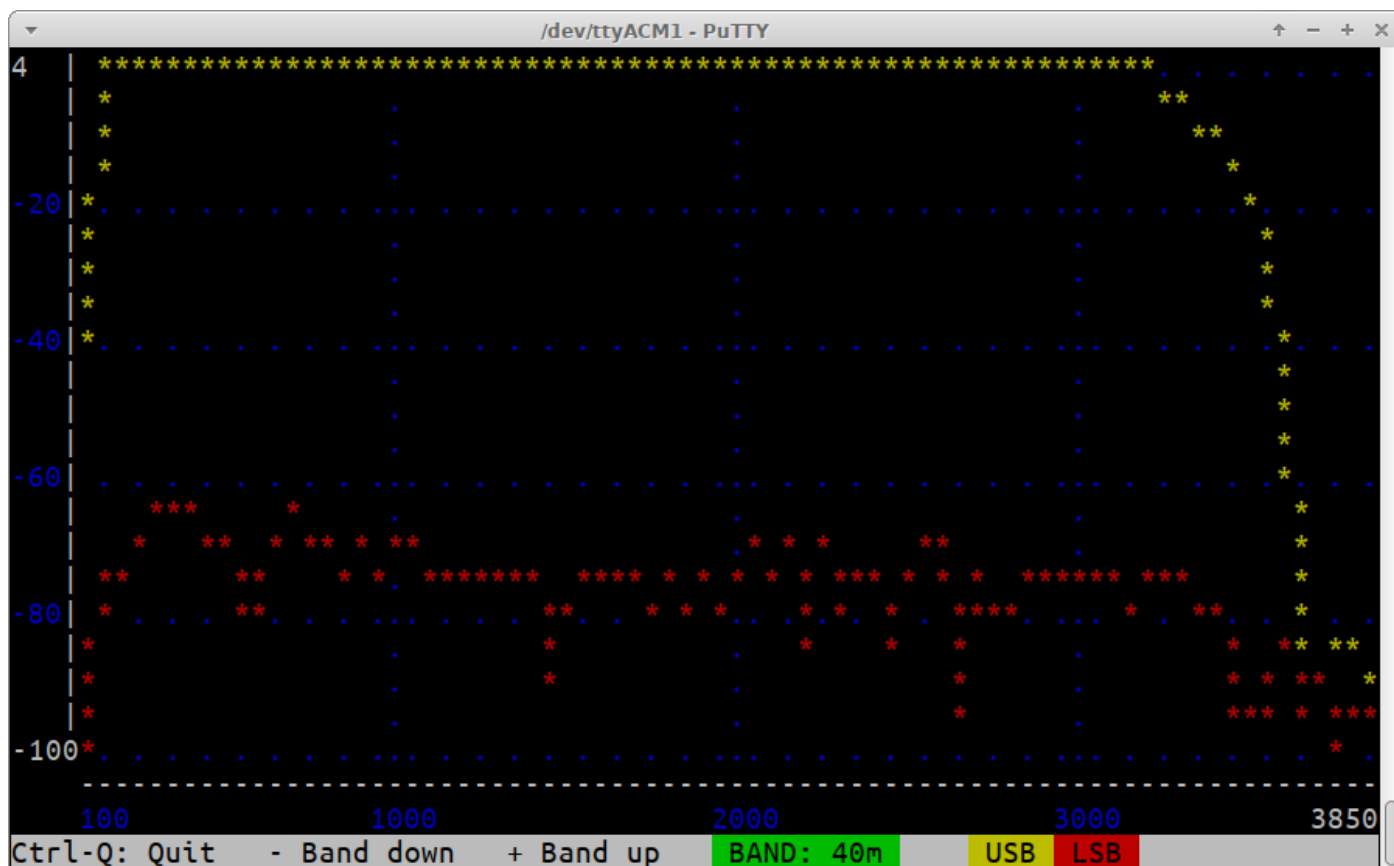

4.7 RF filter sweep

QDX contains its own internal signal generator, which can be used to sweep the receiver input Band Pass Filters, checking its response and center frequency. Though the difference in performance is small, the perfectionist may wish to adjust (by squeezing turns) the Band Pass Filter inductor L12 to optimize the center frequencies of the filters.

Connect a dummy load for best results.

On entering the application, a sweep automatically commences. The percentage completion of the frequency sweep is indicated in the bottom right corner of the screen.

The center frequency and sweep width are defaulted appropriately per band, to show several MHz of frequency sweep cleanly, and are not adjustable. The vertical axis shows audio decibel (dB) level. The offset is arbitrary. Gridlines axis are displayed in blue. Vertical gridlines are every 20dB, and horizontal axis gridlines as appropriate to the band. Gridline labels are displayed in blue; the minimum and maximum audio level (in dB) displayed in white.

A vertical line is shown at the position corresponding to the default operating frequency in the current band. Ideally the peak of the response (line of yellow asterisks) should coincide with the center frequency of the band. The filters are not very very sharp so the performance degradation by being slightly off frequency is not severe. In the example screenshot (40m), the center frequency is incorrectly somewhat below the 40m operating frequency.

The – and + keys can be pressed to move down and up to adjacent bands as defined in the Band configuration screen.

Pressing the R key re-runs the sweep on the existing band.

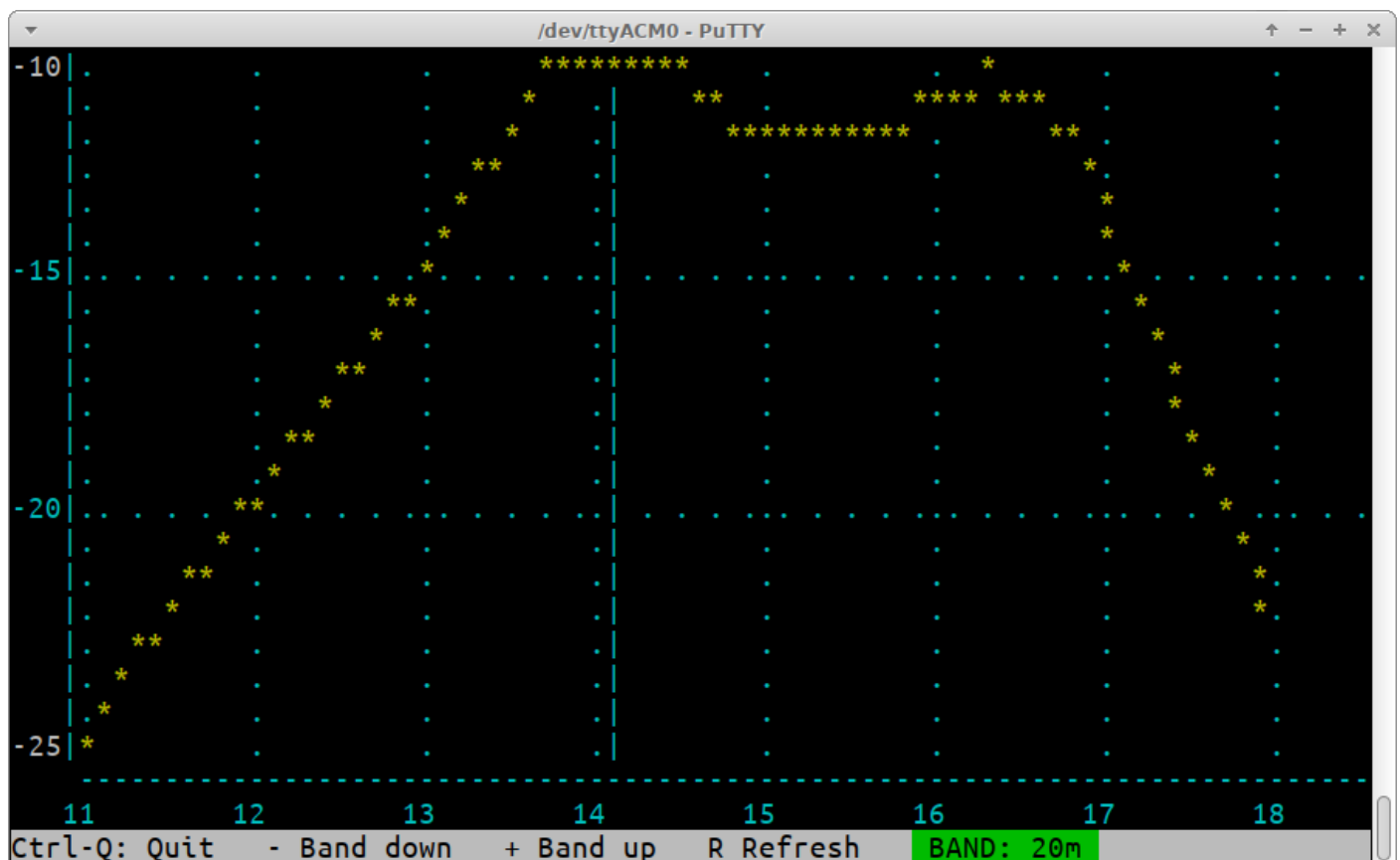

4.8 Input analysis

The Input analysis application is one of the most interesting screens in the QDX Terminal application suite. It shows a “waterfall” which scrolls upward, with the measured audio frequency shown as a yellow block in each row, with its horizontal position determined by its frequency. The scroll rate, and the screen width, are adjustable. The application can be used for checking the accuracy of the frequency analysis (for example when changing configuration parameters “Minimum cycles” and “Minimum samples” at various incoming audio frequencies).

Keyboard controls

During operation, the following keyboard buttons may be pressed to control the operation of the waterfall:

- CTRL-Q: Quit the input analysis application
- Right arrow: Increase the screen width (higher number of Hz per horizontal division)
- Left arrow: Decrease the screen width (lower number of Hz per horizontal division)
- Up arrow: Scroll faster (shorter time interval per vertical division)
- Down arrow: Scroll slower (longer time interval per vertical division)
- Space bar: Pause or un-pause the display; when paused the top right corner text shows “PAUSED” in inverted yellow text
- . (dot): Change the colour of the background gridlines. The default colour is blue. Each time the dot is pressed, the colour changes; it cycles through: Blue, Magenta, Cyan, White, Red, Green, Yellow and then blue again.

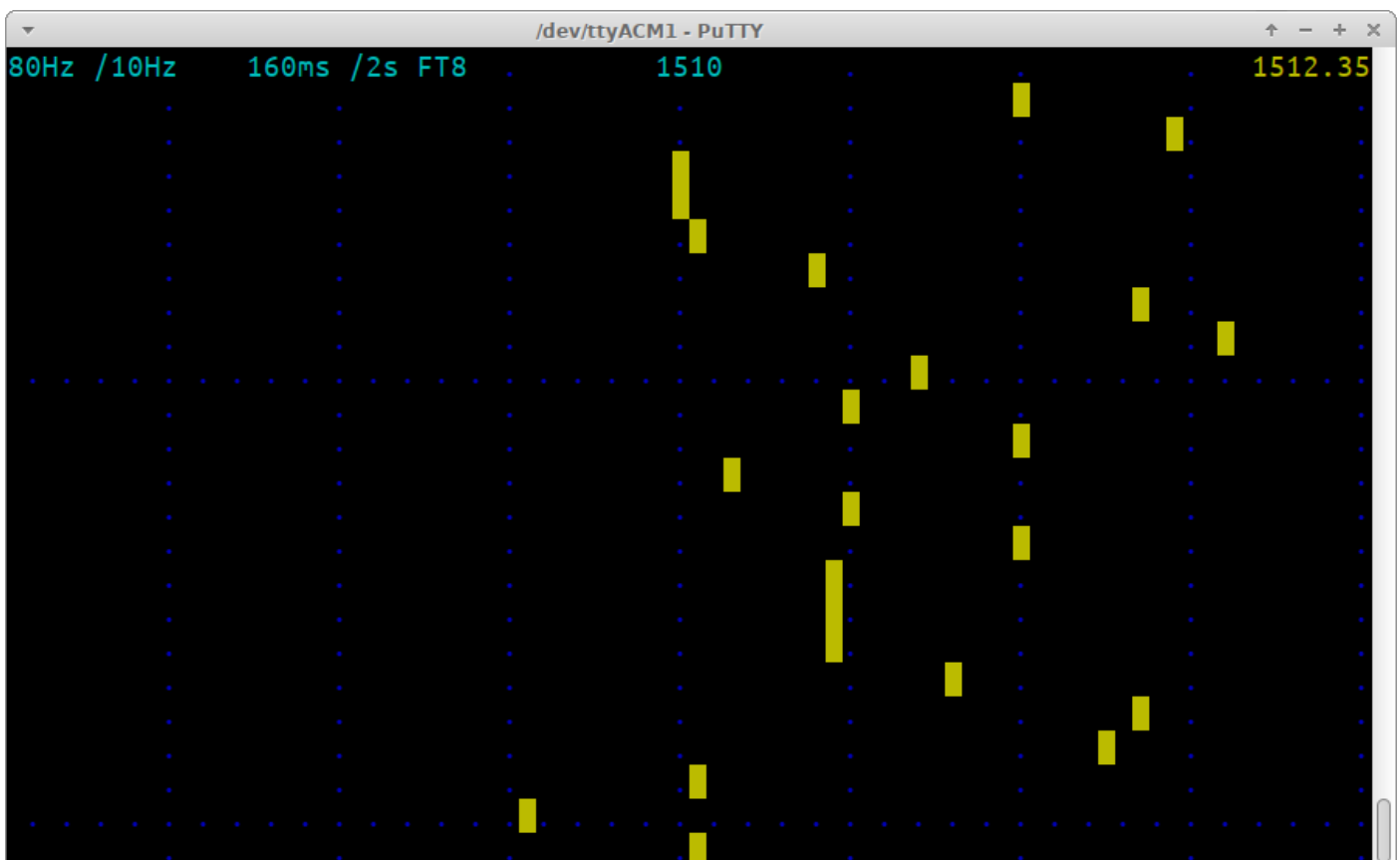

Display elements

This annotated screenshot illustrates the various elements on the display.

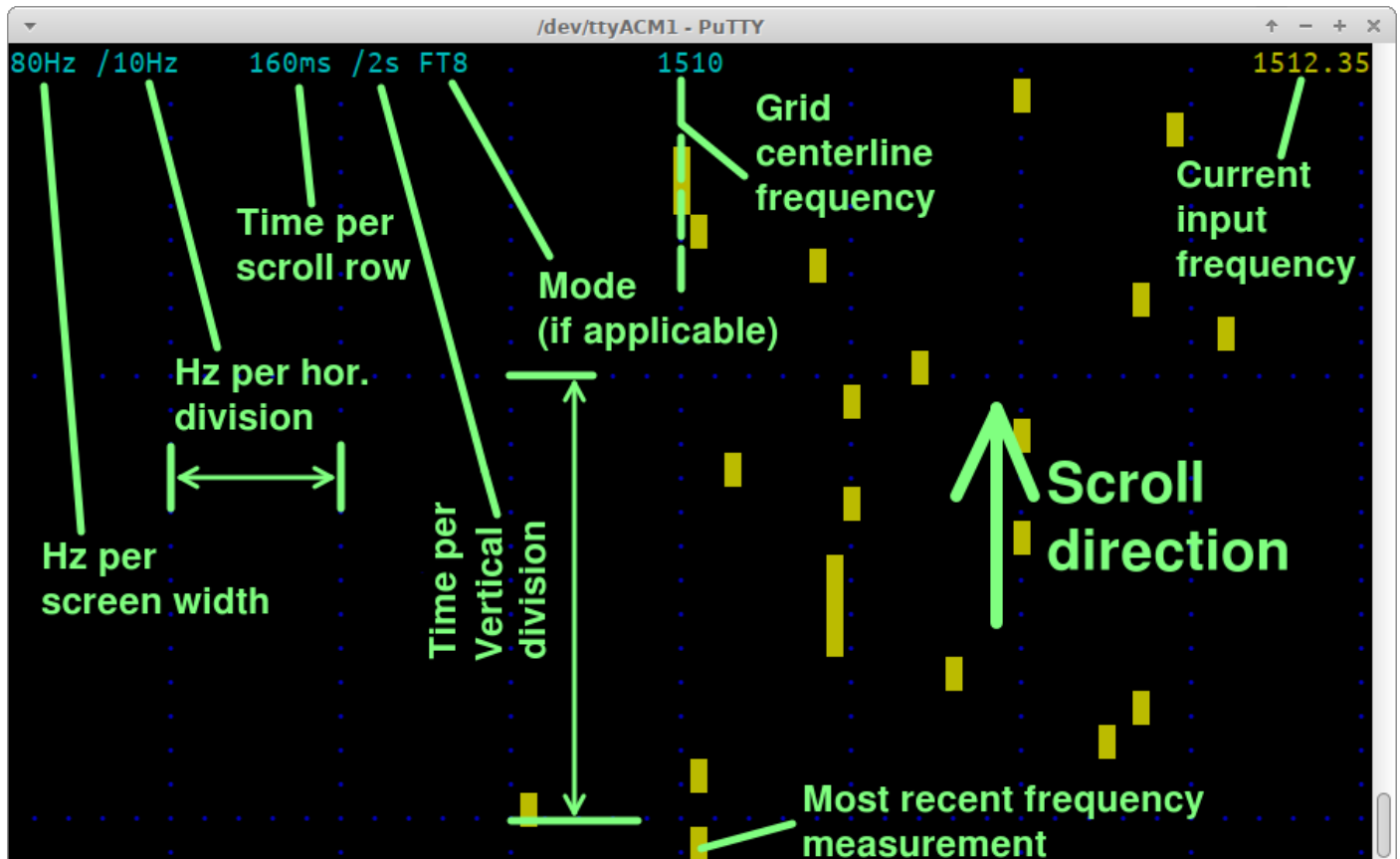

The display elements on the top row are:

- **80Hz:** Total 80-column screen width, in Hz. In this case an 80 Hz wide screen means each block is a 1 Hz Waterfall bucket
- **/10Hz:** Hz per horizontal division. There are always 8 horizontal divisions on the screen. This parameter displays the number of Hz per division.
- **160ms:** the update rate of the screen, or put another way, time per horizontal scroll row.
- **/2s:** The time per vertical division of the screen (distance between the horizontal blue dot grid lines)
- **FT8:** The mode matching this update rate; various popular modes coded and when an update rate matches a mode, the mode name is written here. See below for the list of supported update rates.
- **1510:** Center frequency of the waterfall
- **1512.35:** The most recent frequency measurement
- **NO SIGNAL:** displayed at the top right when no audio signal is detected
- **PAUSED:** displayed at the top right when the screen is paused by the space bar

NOTE: At very fast update rates, which are useful for displaying some features, the screen update is too slow to display all the information and still be capable of updating fast enough. Therefore information is dropped. At 20ms per row (50 row updates per second) the only text on the display is "20ms" in the top left corner; the grid lines are still displayed. At 10ms (100 row updates per

second), even the grid lines are dropped; only “10ms” is written in the top left corner, and the yellow block drawn for the measured frequency.

Update rates:

The available update rates (selected by the up/down arrow keys) are chosen to match various popular modes. For example, the symbol duration for FT8 is 160 ms. So “FT8” is written next to the vertical division rate, on the top row of the display.

Update rate (ms)	vertical Div (s)	Matching mode	Comment
10	1		Only display “10ms” in top left
20	1		Only display gridlines and “20ms” in top left
40	1		
80	1		
160	2	FT8	
227	2	JT4	
361	5	JT65	
576	5	JT9	
683	5	WSPR	

Horizontal size (Hz):

The available horizontal screen size (selected by the left/right arrow keys) are chosen to cleanly fit the 80 columns display width.

Screen width (Hz)	Horizontal Div (Hz)
12	1.5
20	2.5
40	0.5
80	1
160	2
320	4

Demonstration of sliding frequency changes

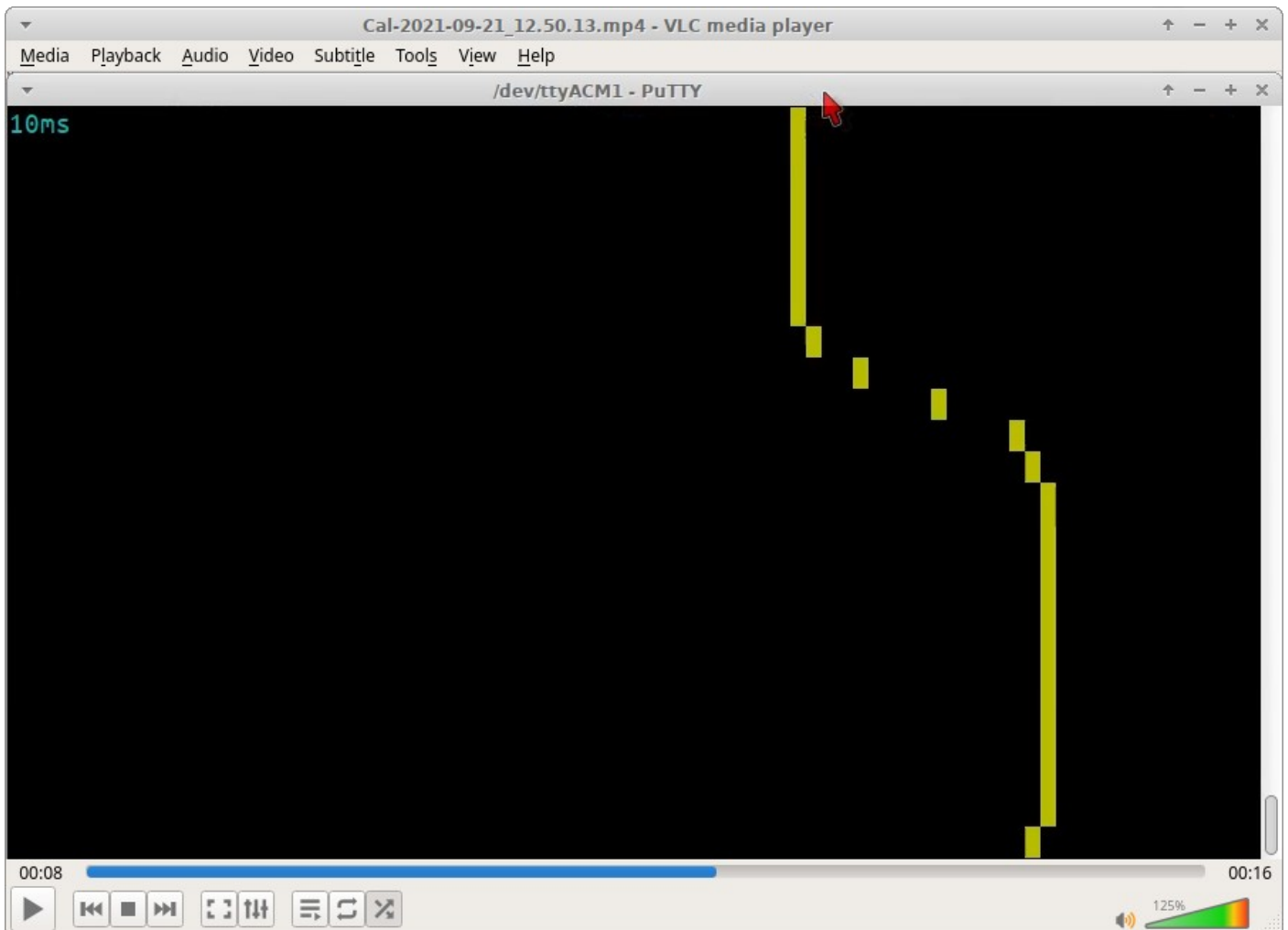

A fun and useful demonstration of the capabilities of QDX and the Input Analysis application, is to investigate the FT8 tone change transition. We know according to the WSJT-X documentation that to avoid splatter onto adjacent frequencies, WSJT-X makes a smooth transition between one tone symbol and the next. It's nice to be able to check this using the Input Analysis screen.

Here the screen width is 80Hz so each horizontal column is a 1 Hz bucket. The FT8 symbol change event is 2 tones (a frequency change of 12.5 Hz since the FT8 tone spacing is 6.25 Hz. The scroll rate is sped up the fastest rate, 10 ms per horizontal row (100 frequency measurements per second).

We see clearly that at the moment the FT8 tone changes, the measured frequency smoothly changes in the expected way from one tone to the next.

Note that an even smoother transition could be made, by setting the "Minimum samples" parameter to 240 samples – this would result in slightly lower accuracy measurement but a smoother transition in tones.

We're talking here about tradeoffs in different aspects of performance; either way the performance is excellent and QDX keeps up with the changes in input frequency! So this is a nice confirmation of the excellent performance characteristics of QDX.

Pressing the M key during input analysis, is another "Easter egg" trick that enables a slightly different mode of operation. In this mode, a window opens in the top left of the display, and scrolls the last 8 CAT commands and CAT command responses. The screen scrolling pauses until the

QDX is in transmit mode (actual audio being received). This mode is really only useful when using a second terminal, or the VGA + PS/2 keyboard terminal, in addition to the normal USB Virtual COM connection being used for CAT control by the host PC software (WSJT-X etc).

This photograph of my VGA monitor was taken during this mode, during a 20m JS8 QSO with Timo OH8XAT.

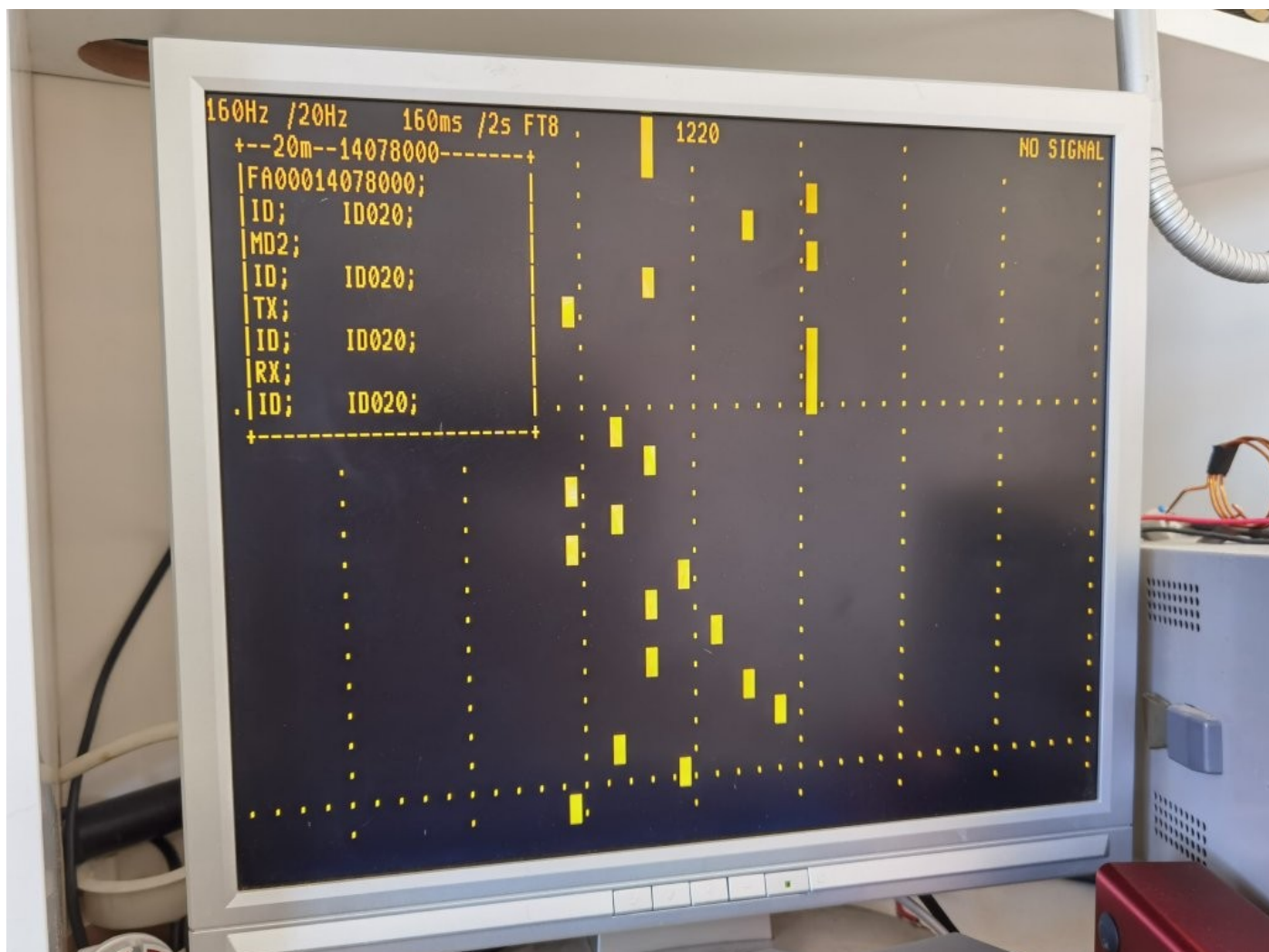

4.9 Image sweep

QDX implements a conversion to baseband, sampling quadrature I and Q channels at 48ksps to a 24-bit stereo ADC then the rest of the receiver is done in Digital Signal Processing in the microcontroller – a Software Defined Radio (SDR). The SDR implements a superhet with 12kHz IF. Like any superhet, this means that there is an image response on the other side of the IF frequency. In this case, that means the image response is 24kHz down the band. The amount of the image rejection depends on:

- Amplitude balance between the I and Q channels
- Any phase error in the 90-degree quadrature relationship

In QDX to date, no attempt is made to compensate for these errors. The image rejection has been found to be adequate without it.

In order to be able to visualize and measure the image rejection, firmware 1_05 introduced the “Image sweep” screen, which sets the VFO to the band center frequency as defined in the Band

Configuration screen, then sweeps the signal generator input from -30.5kHz (below) to +7kHz (above). An example of the resulting sweep is shown below:

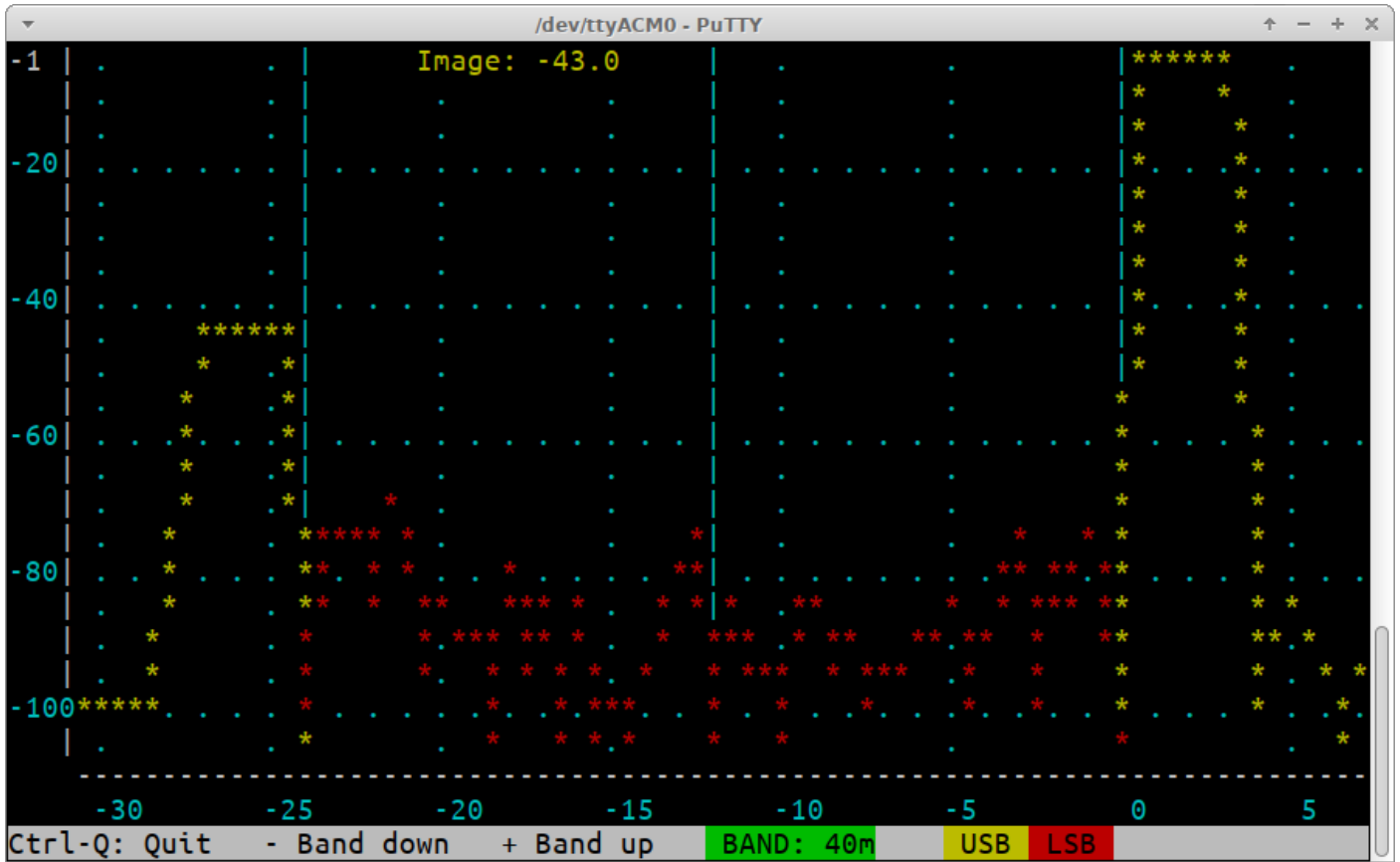

You may get better or worse image rejection than this (depending on your particular combination of component tolerances).

However if you have a significantly worse image rejection then it is time to start debugging your unit; most likely is a problem in the area of the trifilar transformer. Faults such as incorrect wiring (wires in the wrong holes), a broken wire, shorts between wires, etc., can all cause this.

Another cause of poor image rejection, if you have a Rev 3a board, can be the C41 via short fault. Please refer to the Rev 3a Assembly manual for details of how to resolve this fault, if you have not done so already.

In this annotated image, the four audio responses are identified; all four appear in the receivers audio passband. When everything is correct, the three unwanted ones (the lower sideband and the USB/LSB at the image frequency) are at a much lower signal level than the wanted in-channel USB reception.



4.10 CAT command test

The CAT command test application is a simple screen which allows you to test CAT commands. An annoying thing about typing CAT commands directly into a terminal emulator when QDX is in the normal operating mode, is that you cannot see the command you are typing, nor can you edit it if you made mistakes.

Here in this simple application, you can type the command (or commands) you wish to send to QDX in the yellow area of the bottom row. If you forget the trailing semicolon, the application adds one automatically for you. Then simply the command is shown in yellow in the left column, and the command result in yellow in the right column. When the screen is full, it will scroll automatically. Naturally unrecognized CAT commands simply return an error ? as per the CAT specification.

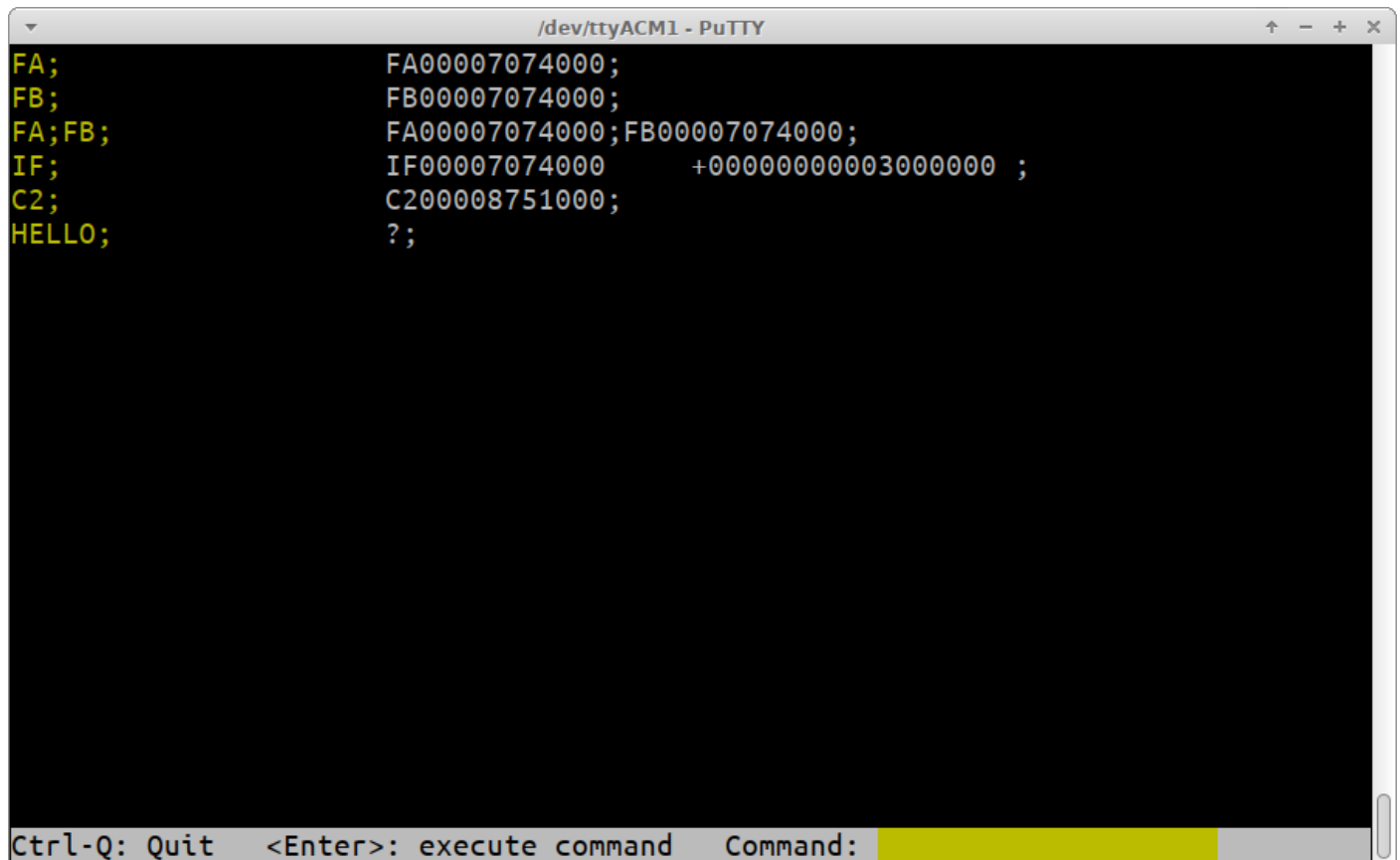

The screenshot shows a PuTTY terminal window titled "/dev/ttyACM1 - PuTTY". The terminal displays the following output for various CAT commands:

```
FA;          FA00007074000;
FB;          FB00007074000;
FA;FB;      FA00007074000;FB00007074000;
IF;         IF00007074000    +000000000003000000 ;
C2;         C200008751000;
HELLO;      ?;
```

At the bottom of the terminal, there is a status bar with the text: "Ctrl-Q: Quit <Enter>: execute command Command:" followed by a yellow input field.

Cat command set

QDX implements a subset of the Kenwood TS-480/TS-440 CAT command set which is an old standard, but contains all the necessary commands for WSJT-X and other software to be able to control QDX, and is old enough that it is widely supported by most software packages.

Additionally QDX provides an extended set of CAT commands Q0, Q1, Q2 and so on until QB. These commands allow a host program to set and get all of the parameters in the QDX configuration screen. Except for the default start-up operating frequency, all of these commands have effect only for the current operating session, they are not stored in EEPROM. If you need to permanently store the configuration parameters in EEPROM please use the Terminal Configuration screen. These commands could be useful for example, if you wish to provide a particular start-up script of CAT commands in your PC software to configure your QDX a certain way.

The following lists the commands and responses in alphabetical order:

<p>AG: Get/Set AF Gain</p> <p>Set: Sets the audio gain. The actual gain setting is the supplied gain in dB. So for example command AG21; will set the gain to 21dB, in the currently active band. Note that the gain can also be set in the Terminal Band Configuration application.</p> <p>Get: Returns the audio gain in dB.</p>
<p>C2: Get/Set Signal Generator frequency</p> <p>Set: Sets the Si5351A Clk2 output frequency (the signal generator).</p> <p>Get: Gets the frequency of Si5351A Clk2 (the signal generator)</p>
<p>FA: Get/Set VFO A</p> <p>Set: Sets VFO A value. Example: FA7030000; sets VFO A to 7.030MHz</p> <p>Get: Returns the VFO A contents as an 11-digit number. Example: "FA;" returns "FA00007030000;"</p>
<p>FB: Get/Set VFO B</p> <p>Set: Sets VFO B value. Example: FB7016000; sets VFO B to 7.016MHz</p> <p>Get: Returns the VFO B contents as an 11-digit number. Example: "FB;" returns "FA00007016000;"</p>
<p>FR: Get/Set Receive VFO Mode</p> <p>Set: Set VFO Mode: 0, 1, 2 correspond to VFO A, VFO B or Split respectively. This is the case for both the FR and FT commands (which are nominally Receive and Transmit VFOs) because in the QDX the VFO mode use does not correspond exactly to TS-480.</p> <p>Get: Get Receive VFO Mode: 0 means VFO A is used for receive (could be due to VFO mode being VFO A, or VFO Mode being Split); 1 means VFO B is being used for receive (must be VFO Mode B).</p>
<p>FT: Get/Set Transmit VFO Mode</p> <p>Set: Set VFO Mode: 0, 1, 2 correspond to VFO A, VFO B or Split respectively. This is the case for both the FR and FT commands (which are nominally Receive and Transmit VFOs) because in the QDX the VFO mode use does not correspond exactly to TS-480.</p> <p>Get: Get Transmit VFO Mode: 0 means VFO A is used for transmit (must be VFO Mode A); 1 means VFO B is being used for transmit (could be due to VFO mode being VFO B, or VFO Mode being Split)</p>
<p>FW: Get filter bandwidth</p> <p>Get: Always returns 3200 meaning, 3200Hz (the QDX's filter bandwidth).</p>
<p>ID: Get radio ID</p> <p>Get: Always returns 020 (Kenwood TS-480)</p>

IF: Get transceiver information (TS-480 format).

Get: Returns a composite information string containing the state of the transceiver, as follows (excluding command ID and ; terminator character):

- 11-digit operating frequency (VFO A or B, according to the VFO mode setting and transmit/receive state
- 5 spaces
- 5-digit RIT frequency, as +/-9999Hz e.g. RIT up 200Hz returns "+0200" in this field
- RIT status: 0 = RIT OFF, 1 = RIT ON
- XIT status: always 0 because QDX has no XIT
- Memory channel bank number: always 0
- Memory channel number: always 00
- Transceiver status: 0 = RX, 1 = TX
- Operating mode: always 3 (CW)
- Receive VFO: 0 = VFO A, 1 = VFO B
- Scan status: always 0
- Split: 0 = Simplex operation (VFO mode A or VFO mode B), 1 = Split
- Tone: always 0
- Tone number: always 0
- Space character

MD: Get/Set operating mode

Set: Set to 1 to set Lower Sideband (LSB) or any other value to set Upper Sideband (USB)

Get: Returns 3 (CW) if the mode is Upper Sideband (USB) which is the normal mode. Returns 1 if the mode is Lower Sideband (LSB).

Q0: Get/Set TCXO reference frequency

Set: Set TCXO reference frequency. Only values between 24999000 and 25001000 are allowed. The setting is for the current operating session only and is not written to EEPROM.

Get: Get TCXO reference frequency.

Q1: Get/Set Sideband

Set: Set sideband; 1 sets Lower Sideband (LSB), any other value sets Upper Sideband (USB). The setting is for the current operating session only and is not written to EEPROM.

Get: Get sideband; 0 = USB, 1 = LSB

Q2: Get/Set default operating frequency

Set: Set default operating frequency. The value IS written to EEPROM.

Get: Get default operating frequency.

Q3: Get/Set receiver Gain

Set: Set receiver gain. The setting is for the current operating session only and is not written to EEPROM.

Get: Get receiver gain. The default value on Factory Reset is 5000.

Q4: Get/Set VOX Enable

Set: Set VOX enable: 1 enables VOX, 0 disables VOX. The setting is for the current operating session only and is not written to EEPROM.

Get: Get VOX enable; 1 = Enabled, 0 = Disabled

Q5: Get/Set TX Rise Threshold

Set: Set TX Rise Threshold, which should be a percentage number between 0 and 99 (see description elsewhere in this manual). The default setting of 80 is normally appropriate. The setting is for the current operating session only and is not written to EEPROM.

Get: Get TX Rise Threshold value

Q6: Get/Set TX Fall Threshold

Set: Set TX Fall Threshold, which should be a percentage number between 0 and 99 (see description elsewhere in this manual). The default setting of 60 is normally appropriate. The setting is for the current operating session only and is not written to EEPROM.

Get: Get TX Fall Threshold value

Q7: Get/Set Cycle Min parameter

Set: Set Cycle Min parameter (see description elsewhere in this manual). The setting is for the current operating session only and is not written to EEPROM.

Get: Get Cycle Min parameter value

Q8: Get/Set Sample Min parameter

Set: Set Sample Min parameter (see description elsewhere in this manual). The setting is for the current operating session only and is not written to EEPROM.

Get: Get Sample Min parameter value

Q9: Get/Set Discard parameter

Set: Set Discard parameter (see description elsewhere in this manual). The setting is for the current operating session only and is not written to EEPROM.

Get: Get Discard parameter value

QA: Get/Set IQ Mode

Set: Set IQ Mode: 1 enables IQ Mode, 0 disables IQ Mode. In IQ Mode, the raw I & Q samples from the ADC are streamed directly to the USB Sound card. The setting is for the current operating session only and is not written to EEPROM.

Get: Get IQ Mode; 1 = Enabled, 0 = Disabled

QB: Get/Set Japanese Band Limits mode

Set: Set Japanese Band Limits mode: 1 enables Japanese band limits, 0 disables Japanese band limits. In Japanese Band Limits mode, QDX cannot transmit outside the allowed Japanese band limits. The setting is for the current operating session only and is not written to EEPROM.

Get: Get Japanese Band Limits mode; 1 = Enabled, 0 = Disabled

<p>RD: Set negative RIT offset amount</p> <p>Set: Sets negative (down) RIT; for example “RD-200;” sets the RIT to -200Hz</p>
<p>RT: Get RIT status</p> <p>Get: Returns RIT status: 0 = RIT off, 1 = RIT on</p>
<p>RU: Set positive RIT offset amount</p> <p>Set: Sets positive (up) RIT; for example “RD150;” sets the RIT to 150Hz</p>
<p>RX: Set the radio into Receive mode immediately</p> <p>Set: Command RX; immediately puts the radio into receive mode. It is equivalent to TQ0;</p>
<p>SP: Get/Set Split mode</p> <p>Set: Sets Split mode: 0 = OFF, 1 = ON. For example “SP1;” switches QDX to split mode</p> <p>Get: Returns the Split state: 0 = OFF, 1 = ON.</p>
<p>TQ: Get/Set transmit state</p> <p>Set: Sets transmit state: 0 = RX, 1 = TX. For example “TQ1;” switches QDX to transmit mode</p> <p>Get: Returns the transmit state: 0 = RX, 1 = TX.</p>
<p>TX: Set the radio into Transmit mode immediately</p> <p>Set: Command TX; immediately puts the radio into transmit mode. It is equivalent to TQ1;</p>
<p>VN: Returns firmware version</p> <p>Get: Returns the firmware version. For example, VN; command returns VN1_05;</p>

4.11 CAT monitor

The CAT command monitor is a very plain blank screen, whose only purpose is to scroll incoming CAT commands from the CAT host, and the QDX responses. You will only be able to use this screen if you have multiple serial ports connected – one (typically the main USB Virtual COM port) to the PC host and one to a terminal (or terminal emulator on a PC, via a USB-Serial converter), running the CAT monitor terminal application.

4.12 Log file

This application is very useful for debugging CAT problems. The log file is stored in the EEPROM chip. The EEPROM chip capacity is 8 KB (Kilobytes) or 8,192 characters. However the configuration parameters also reside in EEPROM, so the available space for the log file is a little less: 8,064 characters, to be precise! When the log file is full, no further characters are written to it.

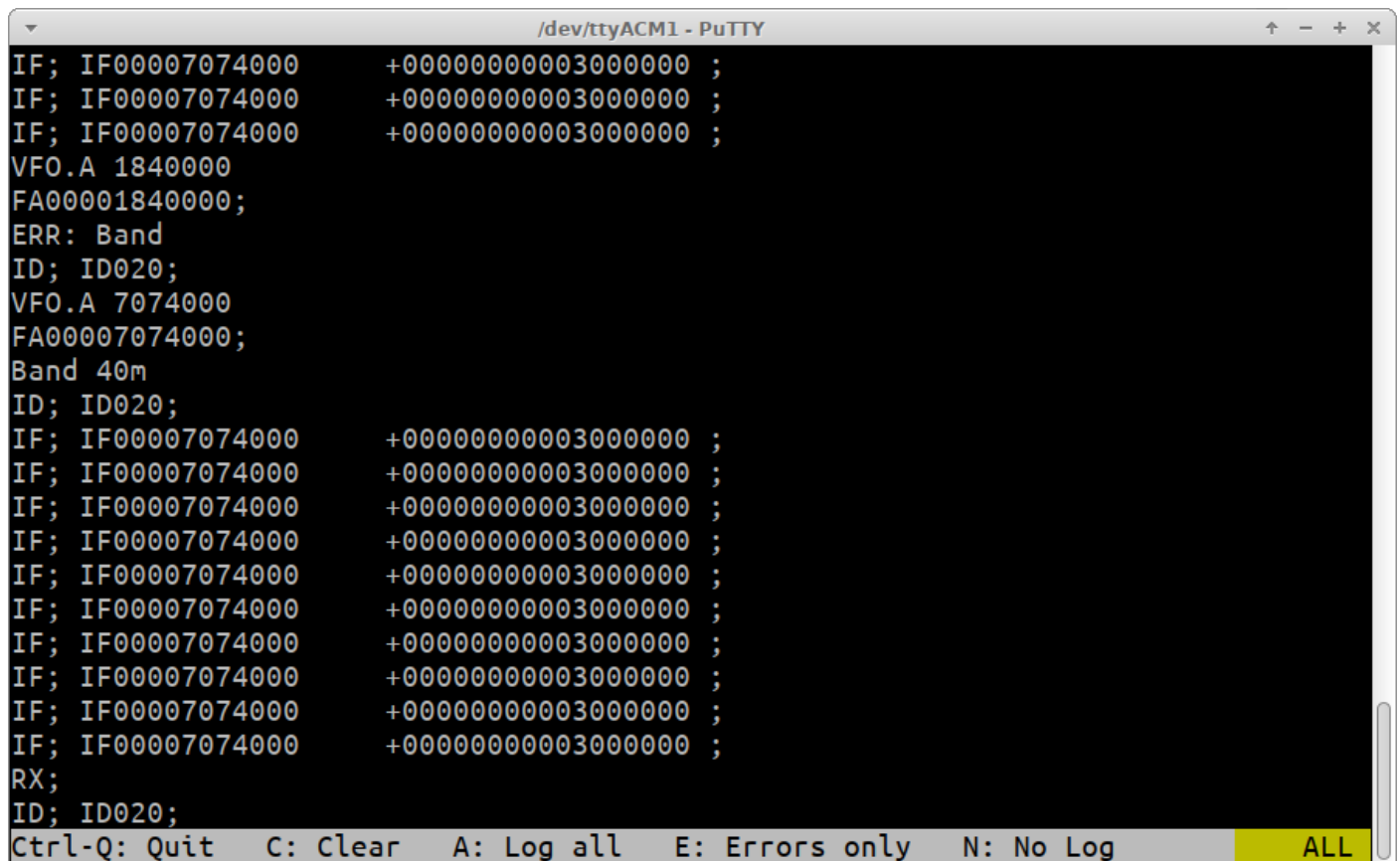

```
/dev/ttyACM1 - PuTTY
IF; IF00007074000 +00000000003000000 ;
IF; IF00007074000 +00000000003000000 ;
IF; IF00007074000 +00000000003000000 ;
VFO.A 1840000
FA00001840000;
ERR: Band
ID; ID020;
VFO.A 7074000
FA00007074000;
Band 40m
ID; ID020;
IF; IF00007074000 +00000000003000000 ;
IF; IF00007074000 +00000000003000000 ;
IF; IF00007074000 +00000000003000000 ;
IF; IF00007074000 +00000000003000000 ;
IF; IF00007074000 +00000000003000000 ;
IF; IF00007074000 +00000000003000000 ;
IF; IF00007074000 +00000000003000000 ;
IF; IF00007074000 +00000000003000000 ;
IF; IF00007074000 +00000000003000000 ;
IF; IF00007074000 +00000000003000000 ;
RX;
ID; ID020;
Ctrl-Q: Quit C: Clear A: Log all E: Errors only N: No Log ALL
```

On opening the Log file application, the existing contents of the log file are displayed. When the screen is full, it will scroll automatically; you can use the scroll bar of the window to see text that has scrolled off the top of the screen if you wish. The current logging status is displayed in yellow in the bottom right corner. In this example, the status is “ALL” which means that all events are being logged.

The available keyboard commands are:

- CTRL-Q: Quit the log file application screen (logging remains active, if enabled)
- C: Clear the log file
- A: Log all events
- E: Log only error events
- N: No logging at all (logging is switched off)

In the log file, each event is written as one line. There are several times of log file entry:

- Errors have the line prefix “ERR:”
- CAT commands are shown (semicolon terminated) followed by the command result, if any. An unrecognized or invalid CAT command would be prefixed by the error code “ERR:”.
- Radio state changes are indicated by the item being changed, followed by the new value.

Various examples from the screenshot above:

VFO.A 1840000	sets the VFO A frequency to 1.84 MHz
FA00001840000;	CAT command from WSJT-X MHz
ERR: Band	Error message "Band"

In this example, a CAT command was received from WSJT-X, to set the QDX to frequency 1.84 MHz. The CAT command is "FA00001840000;" - Note that the entries in the log file are not quite in chronological order, since the VFO update event is printed BEFORE the CAT command event; the reason for this is that the CAT evaluation must be completed in totality before the CAT command log event takes place, because only then do we know if the CAT command was successful. The final entry is an error message "Band" because 1.84 MHz is in the 160m band and this is not one of the bands currently supported by QDX.

VFO.A 7074000	sets the VFO A frequency to 7.074 MHz
FA00007074000;	CAT command from WSJT-X MHz
Band 40m	Sets the band to 40m

The operator then realizes his error setting QDX to 160m in the WSJT-X drop-down and chooses 40m instead; this time the CAT command successfully sets frequency and band.

IF; IF00007074000 +00000000003000000 ;

Here the "IF;" or Information request CAT command is received from WSJT-X and QDX replies with the CAT information string in the prescribed format.

For reasons known only to itself, WSJT-X likes to ask for the information screen multiple times in quick succession even though the result is the same.

The complete list of log events is as follows:

Event	Explanation	Example	Comment
Power up	Occurs every power up	Start 1_00_001	Shows the start event and version number
Set VFO	VFO frequency change	VFO.A 7074000	VFO A is set to 7.074 MHz. VFO B is also available
Band change	Band is set to a new value	Band 40m	An error is generated for bands not supported.
TX	Radio switched to Transmit	TX	Can be either by CAT command or by VOX
RX	Radio switched to Receive	RX	Can be either by CAT command or by VOX
VFO Mode	VFO mode set to A, B, or Split	VFO Mode A	An error is generated for any attempt other than A, B or Split
Split ON/OFF	CAT Split on/off command SP	Split ON	
Clk2	Signal generator frequency is set	Clk2 7075000	
Gain	Set audio gain	Gain 25	Audio gain is set by the AG; CAT command
RIT Down	RIT down CAT command	RIT DN 500	
RIT Up	RIT up CAT command	RIT UP 500	
CAT	Every CAT command	IF;	Every CAT command generates a log entry event

4.13 Transmitter test

The Transmitter Test terminal application is useful for verifying correct operation of your transceiver, and making output power measurements into a dummy load, directly from the terminal rather than needing to use WSJT-X's "Tune" button.

The following keys are used in the Transmitter test application:

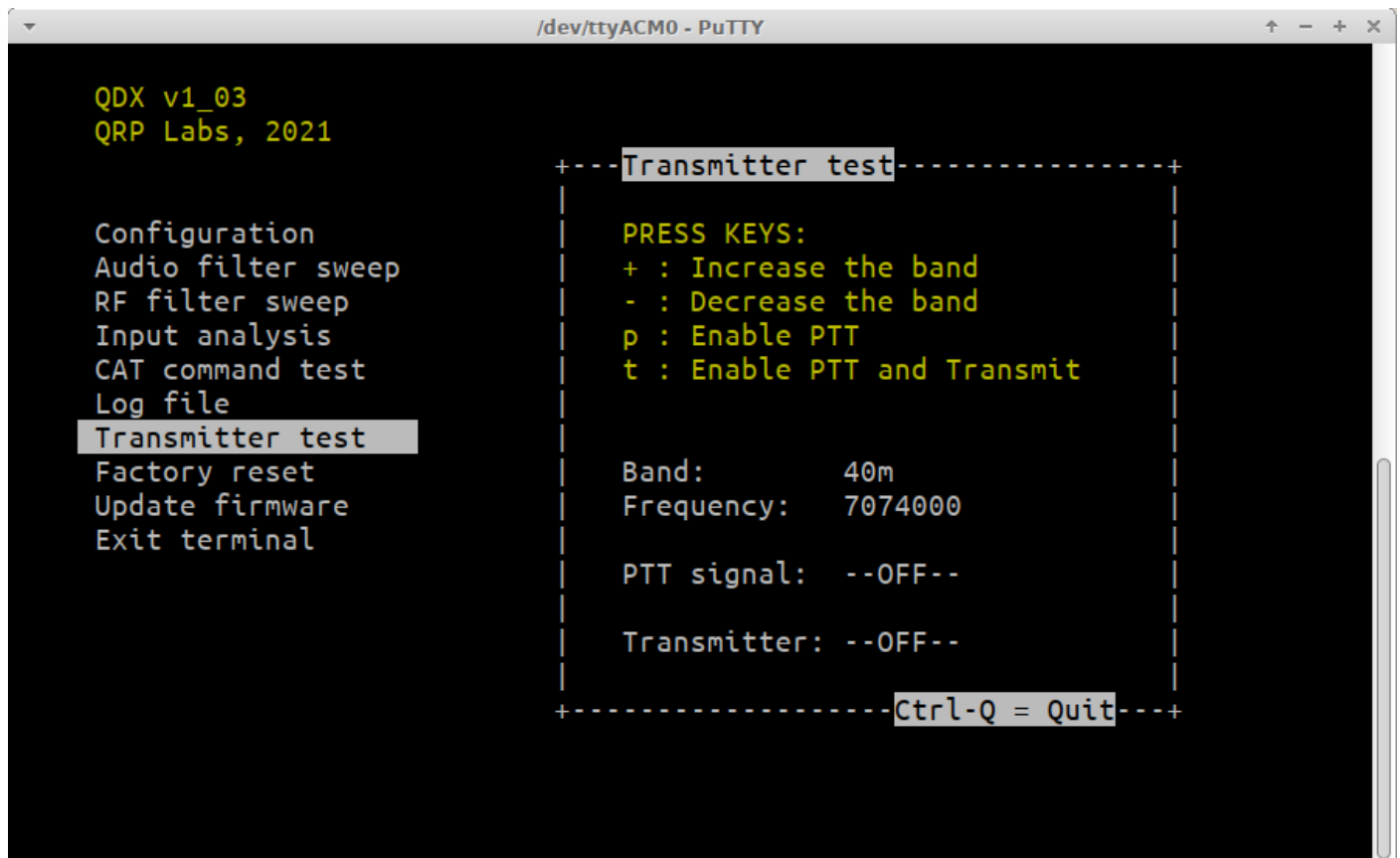

```
/dev/ttyACM0 - PuTTY

QDX v1_03
QRP Labs, 2021

Configuration
Audio filter sweep
RF filter sweep
Input analysis
CAT command test
Log file
Transmitter test
Factory reset
Update firmware
Exit terminal

+-----Transmitter test-----+
|                                     |
| PRESS KEYS:                         |
| + : Increase the band                |
| - : Decrease the band                |
| p : Enable PTT                       |
| t : Enable PTT and Transmit          |
|                                     |
| Band:          40m                   |
| Frequency:     7074000               |
|                                     |
| PTT signal:    --OFF--               |
|                                     |
| Transmitter:   --OFF--               |
|                                     |
+-----+-----Ctrl-Q = Quit-----+

```

- + increases the band
- decreases the band
- p Enable PTT (Highlights in YELLOW)
- t Enable PTT and transmit (highlights in RED)
- Ctrl-Q Quit

The Transmitter test application respects the enable/disable band switches in the Configuration application. So for example, if you have disabled 80m transmit operation, and you have selected the band 80m, then pressing the t key to transmit, has no effect.

The frequency chosen for the transmission is just the default FT8 frequency for the selected band.

4.14 Factory reset

Selecting Factory reset at the main terminal menu, then answering the question “Are you sure?” with “Y”, results in the EEPROM configuration resetting to the factory default state, including restoring the TCXO reference frequency to 25000000 and erasing the log file (if any). Pressing any other key cancels the factory reset.

4.15 Update firmware

Puts QDX into the QFU Bootloader mode, for firmware update. Please refer to the section of this manual describing the firmware update procedure.

4.16 Exit terminal

As mentioned previously, exit terminal returns QDX to normal operating mode, processing incoming CAT commands as usual. The terminal should also be disconnected (or closed) so as to free up the serial port for use by WSJT-X or whatever software you are using – remember that only one PC software application can use the serial port at a time.

5. Troubleshooting Transmit issues

A common problem is that you think you're transmitting in WSJT-X (for example), but QDX is not producing any audio. The 3mm red Status LED on the QDX front panel can be used to debug these issues efficiently. The Status LED flashes during transmit, once, twice or thrice, with the LED on for 0.1 seconds and off for 0.1 seconds between flashes; the sequence is repeated every 1 second. Observe what the LED is doing when you think you are transmitting, and diagnose the fault as below.

No flashes

If the LED does not flash at all when you try to transmit from your host PC application, then you may not have set up your Virtual COM Port setting correctly in the host PC application (for example, WSJT-X). Normally it is recommended to use CAT control to enable PTT, not VOX. When it wishes to switch from transmit to receive (or vice versa) the PC will issue CAT commands over the Virtual COM Port serial interface, telling QDX to switch to transmit. This will only work if the serial port has been correctly set to the port QDX is on, and if you have selected the correct CAT rig (for example, Kenwood TS-440). VOX is not recommended, but if you have enabled VOX PTT rather than CAT, and QDX does not transmit, it means the sound is not reaching QDX (see the 1-flash and 2-flashes diagnostics below).

1 flash:

In this case, the host program on the PC has activated the PTT (Push To Talk) by the appropriate CAT command, switching QDX into transmit mode; however, no audio is being received from the PC over the USB cable link. This is normally because you have not selected QDX as the audio output device in your PC software settings e.g. WSJT-X. Refer to the configuration section earlier

in this manual. The fault could also arise if the output volume is zero, which could be due to the audio output channel being muted somewhere in your PC audio settings.

2 flashes:

QDX is receiving audio from your PC. But the volume is insufficient to trigger the key-down (transmit) action. Remember that there is a “Rise Threshold” setting in the QDX Configuration terminal application, which defaults to 80% of maximum value. If the amplitude of the audio sinewave coming from the PC is less than 80%, key-down will never be triggered.

It is therefore highly recommended to set the audio output level of the PC to 100%. Unfortunately this simple recommendation can be the cause of great confusion. The exact places to set the volume varies also depending on the operating system (Windows, Linux, Mac). But in principle there are THREE places on the PC that all affect the output channel volume, and all three need to be set to 100%:

1. The output volume of the software application itself, for example the “Pwr” slider in the bottom right area of the WSJT-X screen; these should always be left at maximum.
2. The output device corresponding to QDX must be set at 100% also. In Linux Sound Manager (XUbuntu 18.04 example shown), the Output Devices tab for QDX should have its slider set to 100% as per the example below. Don’t set it to more than 100%!

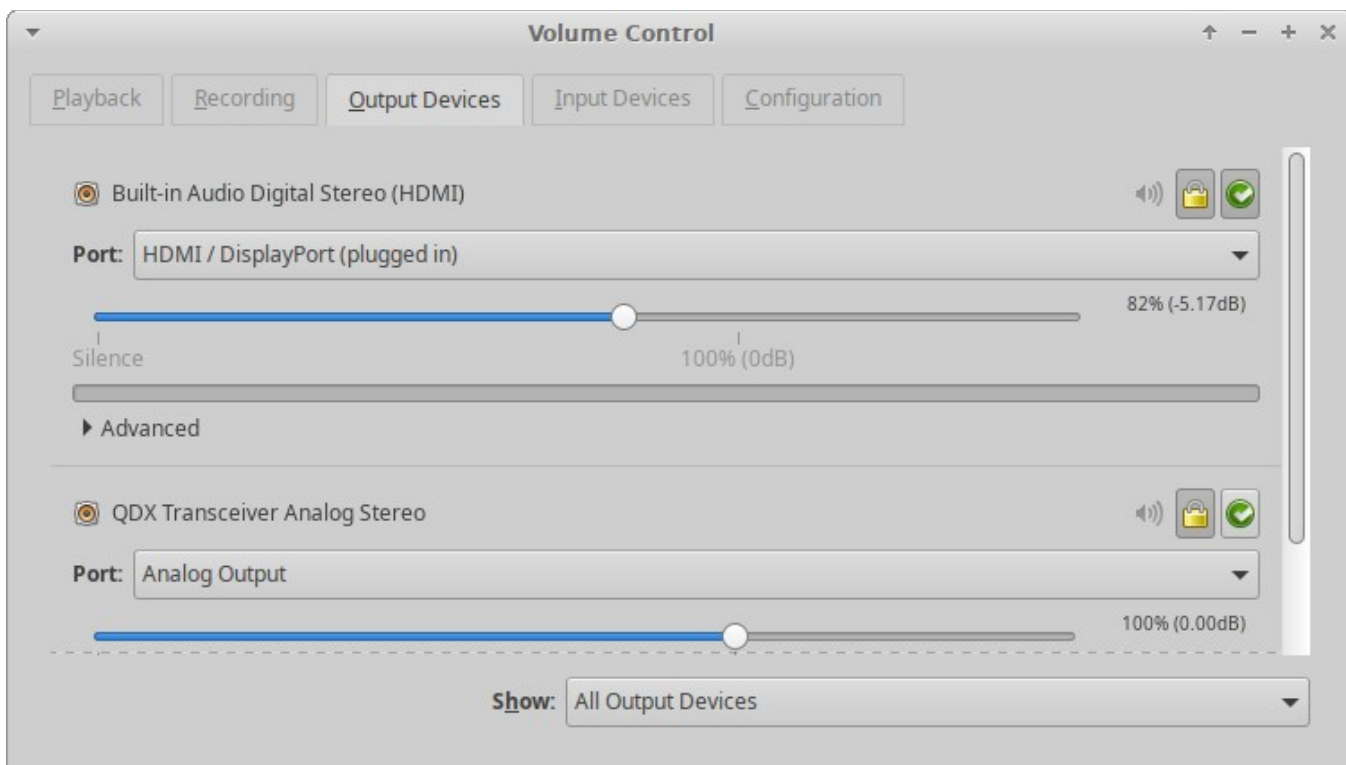

3. The “Master Volume” control of the PC should also be set to 100%. There is such a setting in both Windows and Linux (and most likely Mac too). In Linux, clicking the loudspeaker icon at the bottom right of the screen shows which audio device is being used for the default sound output; selecting QDX will show you the master volume level, and it needs to be set to 100% (not more, not less). There’s a similar thing on Windows OS.

3 flashes

If the status LED is flashing three times, this means that QDX is being correctly commanded to go to transmit mode (the host application activates the PTT CAT command), QDX is detecting and measuring the audio from the PC, and furthermore, the audio is of sufficient level to activate the QDX transmit.

If you are STILL not getting power output then this indicates a hardware problem, either with QDX, or with the connections to your power meter.

QDX transmitter hardware problems are often the result of failure to properly remove the enamel from the enameled copper wire on the toroids and/or binocular core, resulting in no electrical connection.

6. Resources

- For updates and tips relating to this kit please visit the QRP Labs QDX kit page <http://qrp-labs.com/qdx>
- For any questions regarding the assembly and operation of this kit please join the QRP Labs group, see <http://qrp-labs.com/group> for details

7. Document Revision History

1_03	23-Dec-2021	First version, for firmware 1_03
1_04	20-Jul-2022	Firmware 1_04 changes
1_05	30-Sep-2022	Firmware 1_05 changes
1_05a	30-Sep-2022	Added notes in section 4.5 about the Band name parameter operation in determining behaviour below 3MHz and the RF Sweep limits.