

QMX: QRP Labs Multimode Xcvr (transceiver) Assembly manual

--- PCB Rev 4 ---

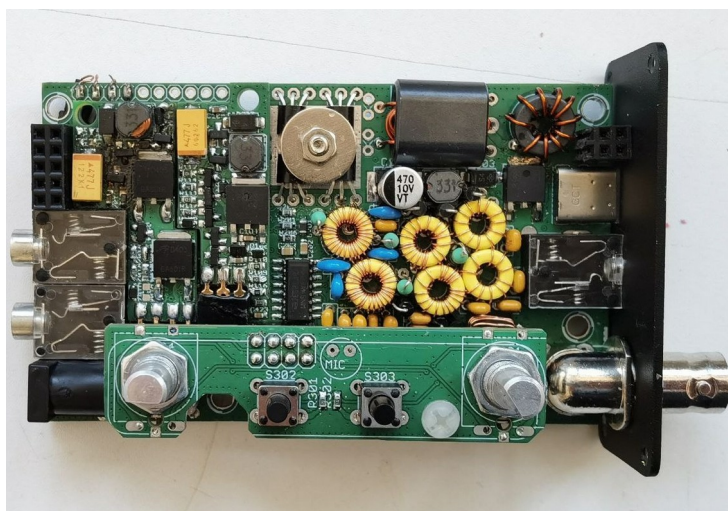

Contents

Contents.....	2
1. Introduction.....	3
2. Assembly.....	5
2.1 General guidelines.....	5
2.2 PCB diagrams (trace, component identification).....	10
2.3 Parts list.....	17
2.5 Install all the ceramic capacitors.....	25
2.6 Install 1N4007 diodes.....	28
2.7 Install 47uH inductors.....	29
2.8 Install BS170 PA transistors.....	30
2.9 Assemble and install transformer T501.....	31
2.10 Prepare and install tapped inductor L401.....	34
2.11 Wind and install L502.....	43
2.12 Install Low Pass Filter toroids.....	44
2.13 Wind and install trifilar toroid T401.....	47
2.14 Wind and install transformer T507.....	50
2.15 Install connectors.....	51
2.16 Install pin header connector sockets (female).....	52
2.17 Install power supply boards.....	53
2.18 Install LCD module.....	57
2.19 Install 2x5-pin and 2x2-pin male pin header connectors.....	58
2.20 Install four 11mm nylon spacers.....	58
2.21 Install 20K trimmer potentiometer R305.....	59
2.22 Install 2x4-pin male header on controls PCB.....	60
2.23 Install rotary encoders.....	61
2.24 Install tactile switch buttons.....	62
2.25 Install electret microphone.....	62
2.26 Install 11mm nylon hex spacer.....	63
2.27 Fit Controls PCB to main PCB.....	64
2.28 Plug together the boards.....	64
2.29 QMX GPS interface and PTT output.....	66
2.30 FINAL CHECKS BEFORE APPLYING POWER THE FIRST TIME!.....	68
2.31 Connections for basic operation.....	69
2.32 Firmware installation.....	70
2.33 Optional enclosure.....	74
3. Resources.....	77
4. Document Revision History.....	77

1. Introduction

The QMX is a high performance, five-band 5W CW and Digital modes transceiver with CAT control and built-in USB sound card.

- Three versions: 80, 60, 40, 30, 20m, 60, 40, 30, 20, 17, 15m and 20, 17, 15, 12, 11, 10m
- 5W from a 9V or 12V supply (build options)
- Clean single signal output (zero residual carrier, zero unwanted sideband)
- Sunlight viewable, large 16 x 2 character yellow/green LCD, switchable backlight
- Built-in SWR metering and protection
- Lightweight: 210 grams
- Solid state PIN-diode switched Low Pass Filters and solid state Band Pass Filters
- Solid state transmit/receive switching
- High performance embedded-SDR SSB receiver using 112dB 24-bit stereo ADC chip
- Built-in USB sound card: 48ksps 24-bit stereo
- Built in USB Virtual COM port serial for CAT control
- Si5351A Synthesized local oscillator with better than 0.001Hz resolution and high precision 25MHz TCXO reference as standard
- Built-in signal generator
- Built-in suite of configuration and analysis tools
- Built-in iambic keyer
- On-screen S-meter
- CW decoder
- CW: Full or semi QSK, fast break-in; VFO A/B/Split, RIT, configurable offset, sidetone
- Beacon mode: standalone CW, FSKCW or WSPR operation
- GPS interface for real-time clock and frequency discipline for WSPR operation
- Lifetime free firmware upgrades with QRP Labs Firmware Update (QFU) bootloader for easy firmware update on any OS with no extra software, or drivers, or programming hardware
- All SMD pre-installed by factory, only through-hole component soldering by the constructor
- Low receive current (switching buck converters) 80mA; Transmit current 1.0 – 1.1A (transmit dependent on power supply; example is approximately for 9V supply, 5W output)
- Connectors: USB-C (audio and serial for CAT), Power, PTT (external amp), audio out, paddle and RF
- Optional smart aluminium extruded enclosure measuring just 95 x 63 x 25mm

No test equipment is required to build, align and operate this digi modes transceiver. All adjustments can be made using built-in test equipment; or left alone (the transceiver will work well even with no adjustment).

We hope you enjoy building and operating this kit! Please read this manual carefully, and follow the instructions step by step in the recommended order. The construction is necessarily very compact and so it is important to really give attention to ALL the details described in this manual.

The circuit theory is described in detail in another document and we recommend reading and understanding this section too, to get the maximum enjoyment and education from your new radio.

The operating manual is a separate document and will get you started with QMX with CW, or with your WSJT-X or other digi modes software, in minutes.

PLEASE READ THE BASIC ASSEMBLY AND USE INSTRUCTIONS IN THIS MANUAL VERY CAREFULLY BEFORE APPLYING POWER TO THE BOARD!

IMPORTANT!

QMX can be built for 9V or 12V operation! You need to decide NOW!

A 9V QMX produces 5 W power output from a supply voltage of 9V or a little over. At 12V, a QMX built for 9V could be producing 8 W power output which is likely to cause over-heating and perhaps failure of the BS170 final transistors. Do not power a QMX with a higher voltage than you built it for.

Operation of QMX at more than 5W power output is NOT RECOMMENDED.

If you wish to operate using a 12 V supply, you may use a two turn secondary winding on the output transformer T501, so a 3:2 ratio instead of the 3:3 turns ratio documented in this manual. Remember this when you come to the assembly step for preparing and installing the output transformer T501. The “primary” is still 3 turns, with a tap half way at 1.5 turns. The secondary (no tap) will now be only two turns.

The chart below shows the measured power output vs supply voltage for the standard 3:3 winding (Red line); at 12 V supply the output power of around 8 W is too high and likely to cause over-heating or failure of the power amplifier transistors. If you wish to use a supply of 12 V the 3:2 winding style is more suitable and will produce 4 – 5 W output for 12V supply. The graph shows 40m but other bands are very similar.

Operation at more than 12V will reduce the protection safety margin available in the event of very long key-downs, hot environment, antenna mismatch, cable faults etc. I don't recommend more than 12V. It isn't worth pushing more just for a fraction of a dB. It is acceptable to use diodes in series on the power line, each one will drop the voltage 0.6V or so. Beware that a 12V nominal battery will potentially be several volts higher when fully charged.

40m power output vs Voltage, transformer windings

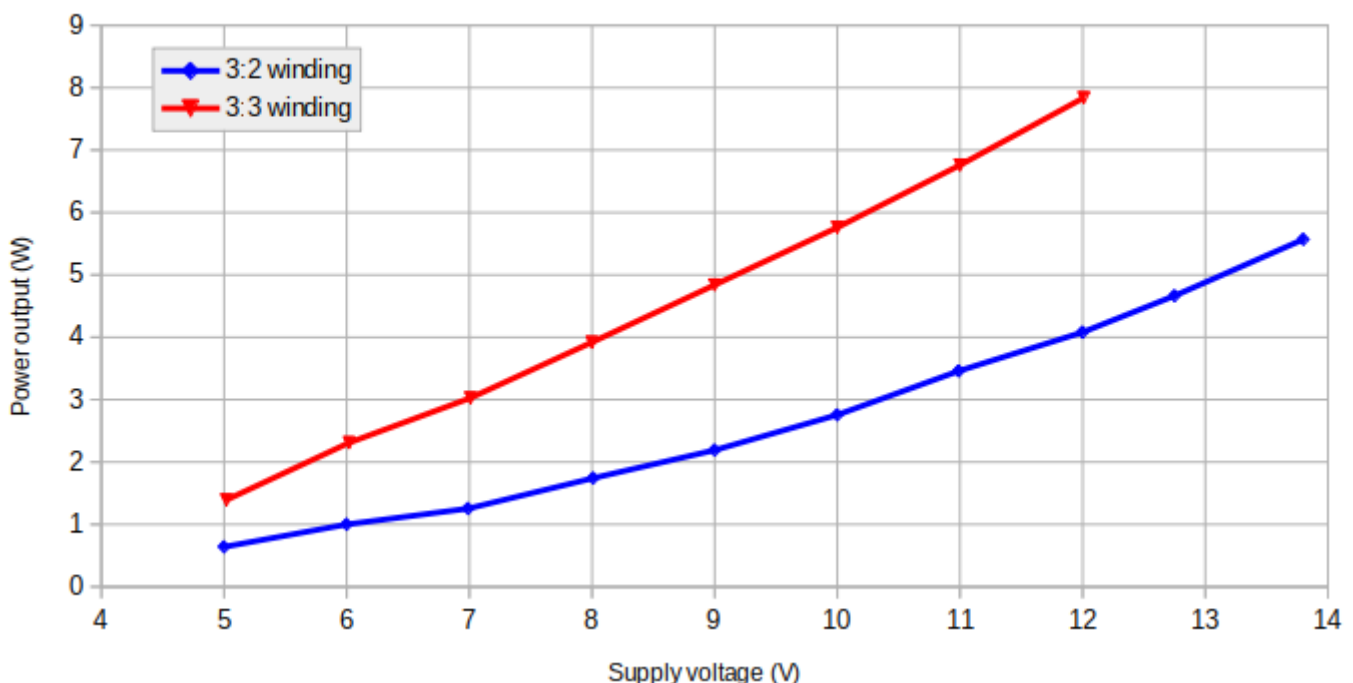

2. Assembly

2.1 General guidelines

Assembly of this kit is quite straightforward, but very detailed; most components are SMD and have already been pre-assembled by the PCB factory. The usual kit-building recommendations apply: work in a well-lit area, with peace and quiet to concentrate. **Some of the other semiconductors in the kit are sensitive to static discharge. Therefore, observe Electrostatic discharge (ESD) precautions.**

And I say it again: **FOLLOW THE INSTRUCTIONS!!**
Don't try to be a hero and do it without instructions!

A jeweler's loupe is really useful for inspecting small components and soldered joints. You'll need a fine-tipped soldering iron too. It is good to get into the habit of inspecting every joint with the magnifying glass or jeweler's loupe (like this one I use), right after soldering. This way you can easily identify any dry joints or solder bridges, before they become a problem later on when you are trying to test the project.



You could also take photos with a mobile phone, and use the phone's zoom features to view the board in detail.

Triple check every component value and location BEFORE soldering the component!

It is easy to put component leads into the wrong holes, so check, check and check again! It is difficult to de-solder and replace components, so it is much better to get them correctly installed the first time. In the event of a mistake, it is always best to detect and correct any errors as early as possible (immediately after soldering the incorrect component). Again, a reminder: removing a component and re-installing it later is often very difficult! This is particularly true on this QMX design where the components must be installed very close together.

Please refer to the layout diagram and PCB tracks diagrams below, and follow the steps carefully.

Use of a good quality soldering iron and solder is highly recommended for best results!

The following diagrams show the PCB layout and track diagrams of the QMX.

6-layer PCB

QMX is a 6-layer PCB. This means that there are two internal ground-planes and two internal signal layers, in addition to the normal top and bottom signal layers. This is necessary in order to achieve the required component density in the QMX design, as well as to achieve the required ground-plane, signal ground return paths necessary to deliver low-noise and high performance with such a high component density in a mixed mode (analog/digital) board.

Because of the internal layers it is essential that you never ever drill into the PCB; just because you think you see a clear spot on the top and bottom layers, does NOT mean that there is nothing hidden in the middle.

There should never be any reason to drill into the board anyway but I'm just saying, in case for some peculiar reason you feel an irresistible temptation to go wild.

Tracks shown in BLUE are on the bottom layer. Tracks shown in RED are on the top layer. One internal layer is used mainly for transporting digital and analog signals relatively long-distance on the board, and these traces are shown in YELLOW. One layer is used primarily (but not exclusively) for power rails (12V, 5V, 3.3V). These traces are shown in PURPLE. Two of the internal layers are used ONLY for ground-plane with no exceptions. Additionally, all un-used area on ALL the layers, is assigned as ground-plane wherever possible, with frequent ground plane stitching vias connecting the layers on all 6 planes, at intervals not more than 0.1 inches.

For best RF low noise performance, any signal transitioning between layers should have a nearby ground via stitching the ground-planes together, placed as close as possible, to minimize emissions due to discontinuity of the ground return paths. Frequent ground plane stitching also prevents the creation of internal microwave cavities which could resonate and enhance noise propagation between harmonics of digital signals and sensitive RF signals.

This diagram from the Eagle CAD “Design Rules Check” illustrates the layer set-up which is based on the specification of the PCB manufacturer.

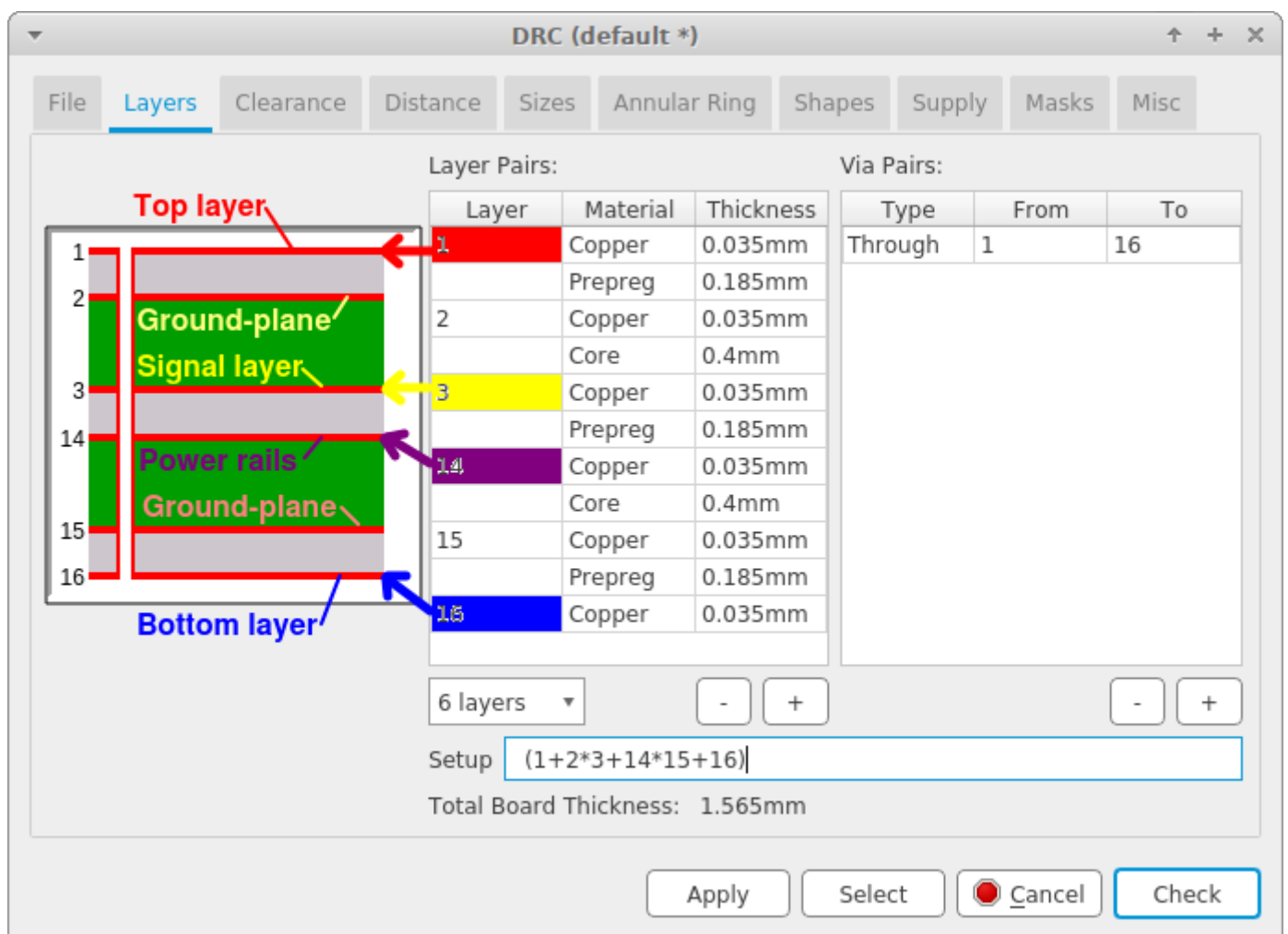

You will note that there is only one type of via, which goes through the entire board through all 6 layers. In many cases, a signal actually only needs to transition part-way through the board, for example from the bottom layer (16) to the internal signal layer (3). Other types of via are possible, which are called “blind” and “hidden” or “buried” vias.

Blind via: has one end on the board surface layers, and drills through to an internal layer where it terminates. It does not have a drill hole all the way through the board, so other components and traces could be placed on the opposite board surface or on internal layers without conflict.

Hidden or buried via: neither ends of the via are visible on either surface; the via transitions signals entirely between internal layers only.

Unfortunately a 6-layer board is much more expensive than a 2-layer board; and if you use blind or hidden vias the costs escalate even more drastically. For this reason, no blind or buried vias are used in the QMX. It is necessary to use a 6-layer board, but the design is not so complex or compact that blind or buried vias are needed.

NOTE: the capacitor lead spacing on the PCB is 0.1-inches (2.54 mm) and most of the capacitors are sized appropriately for this. From time to time, due to availability constraints, we may have to use capacitors with 0.2-inch lead spacing (5.08 mm); this is not a mistake, it is just due to component availability. In this case simply use a pair of long-nosed pliers (etc) to straighten out the wires and make them spaced for the 0.1-inch pads.

Board structure

The QMX PCB is on a single panel, which must be broken apart very carefully into smaller pieces. Do not lose any of the pieces, some of which are quite small. Take great care not to damage any of the small boards. **The following page shows a diagram of the PCB panel, with the constituent parts outlined in red.**

The easiest way to break out the boards is to use needle-nosed pliers or wire-cutters, grab each of the breakaway tabs colored in yellow, and gently twist it to remove it from the panel, leaving only the wanted small PCBs. **The rough edges must be filed flat carefully, taking care not to damage any nearby SMD components, particularly applicable to the small power supply boards.** The tiny control board spacers don't particularly need the rough edges filed.

The large PCB panel supplied is broken out into the following pieces:

- **LCD board:** This is the top board of stack, the LCD module is bolted and soldered to it.
- **Controls board:** breaks out of the LCD board, holds the rotary encoders and buttons
- **Controls board spacers:** two tiny boards, also part of the LCD board; these are very important to obtain the correct height of the controls board; be careful not to lose them!
- **Main board:** the main PCB of the QMX with most of the components, on both sides.
- **Power supply boards:** two PCBs that have the 5V and 3.3V buck converters, reverse polarity protection, soft power switch, and 3.3V linear regulator. The board shapes are irregular, be careful not to break any small protrusions.
- **Keyfob:** QRP Labs fashion: break this out, file the edges smooth, and put it on your key-ring; enjoy your QRP Labs keyfob with pride

NOTE: There may be a rail of unused PCB material, 5mm wide, attached to the left side of your boards. This simply a remnant of the manufacturing process. You can easily snap this off carefully using pliers. There is already a V-groove on both sides of the PCB so removing it should be easy.

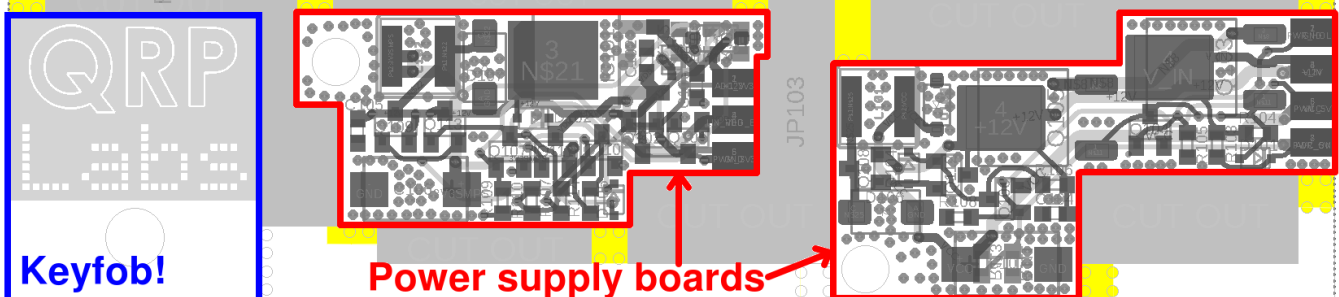
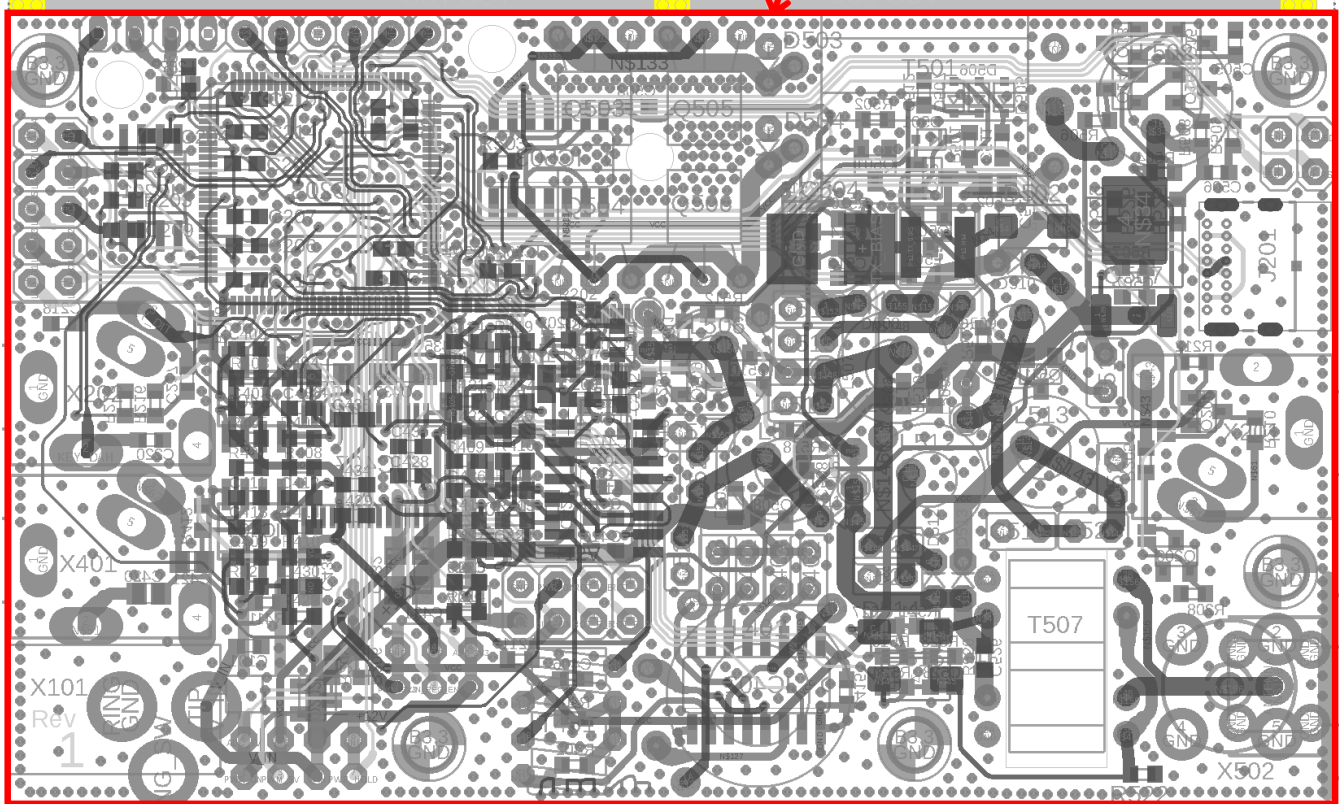
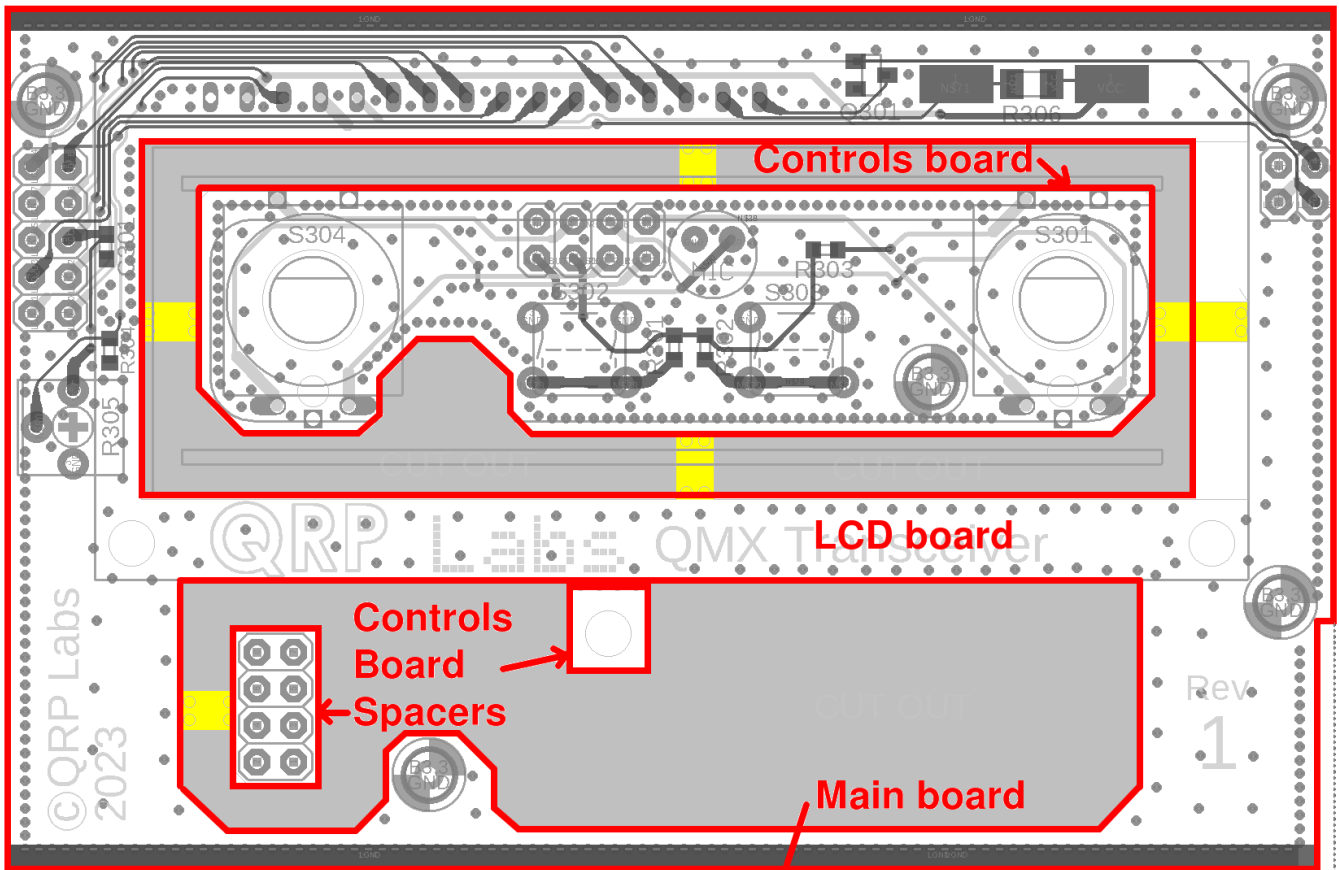

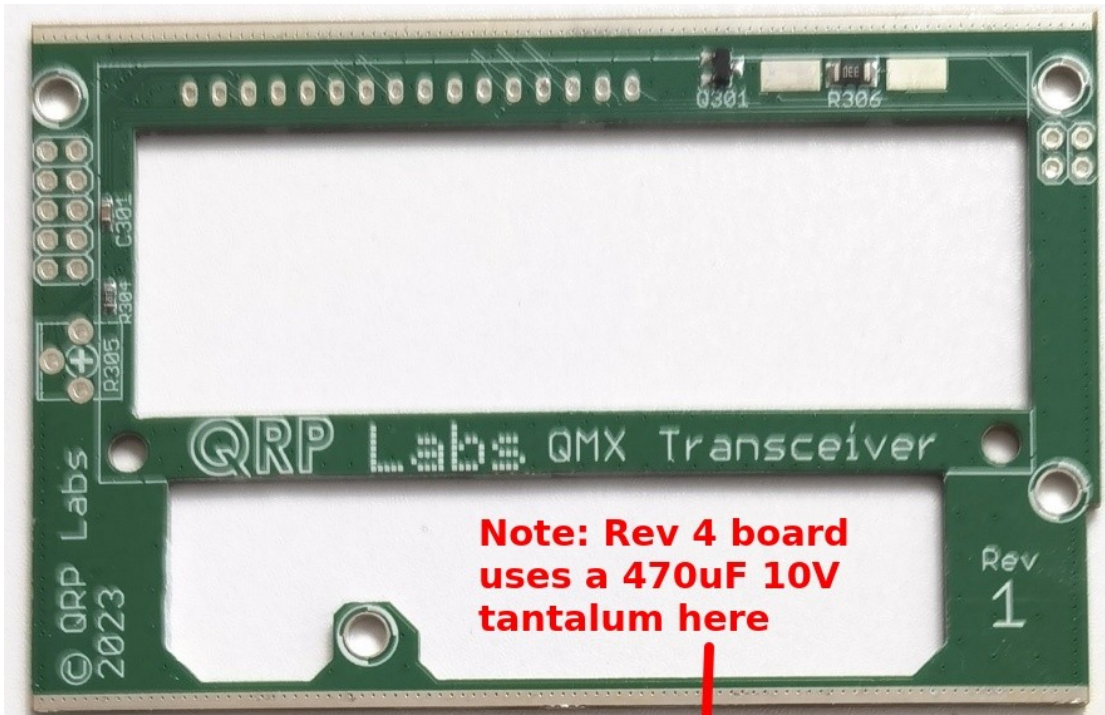

Note: Rev 4 board uses a 470uF 10V tantalum here

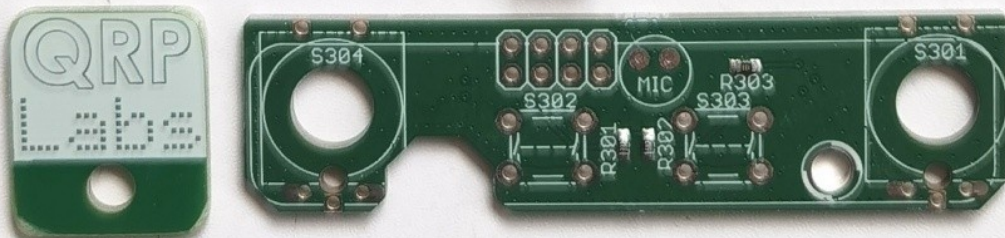
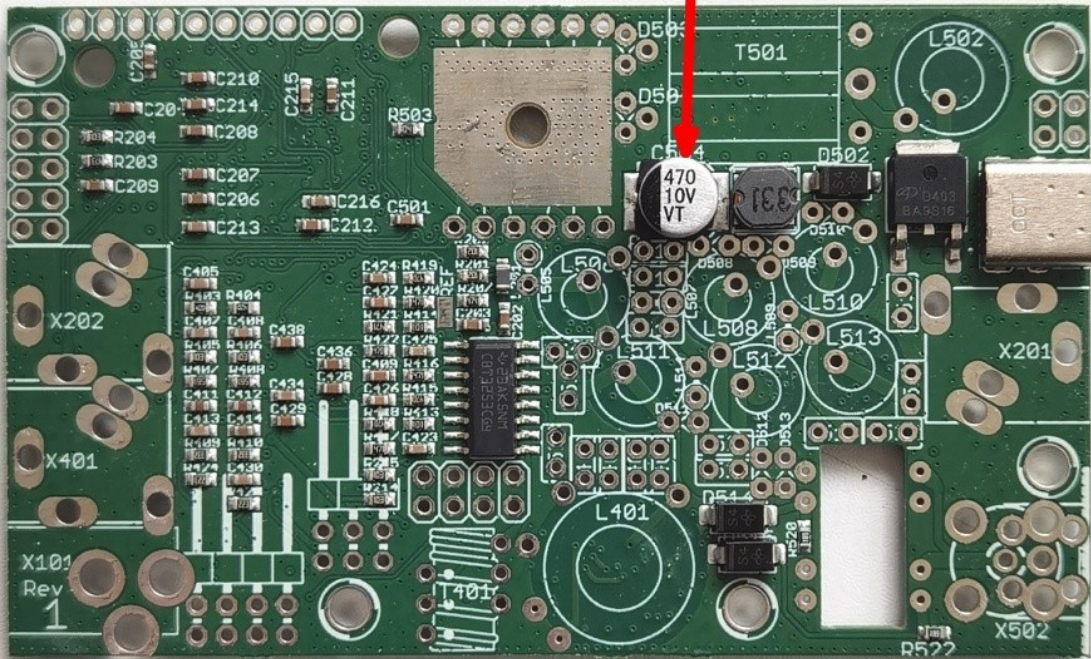

Tips for a successful build:

1. READ the manual, and every instruction carefully! Don't try to be a hero (proceed without reading carefully). There are many more people who will need to buy a new board, than real heroes...
2. Don't rush! Take your time!
3. Use good lighting!
4. Use a jeweler's loupe to check component values of capacitors BEFORE soldering.
5. Use a soldering iron with a fine tip and high power. For example 60W
6. When soldering capacitors (and other components), note that where pins are grounded, these typically need a lot more heat to ensure a good clean joint. A common error is poorly soldered ground connections of LPF capacitors, which causes incorrect filter performance (often manifested as low power output).
7. When soldering and clipping component leads, be very careful of nearby SMD components which could easily be damaged. Before soldering/clipping, identify nearby SMDs, then make sure that you approach the lead to be soldered or clipped from the opposite direction to the nearby SMD component.
8. KEEP the component lead offcuts from the capacitors – they are used later when installing the LCD module.
9. Solder connectors with no more heat and time necessary to create a good solid clean joint to avoid melting the plastic body parts of the connectors.
10. Remember diodes MUST be connected the correct way round!
11. After every joint, inspect with the jeweler's loupe to check for a good clean joint and any solder bridges to any nearby components: a lot of the components are packed very close together.
12. Clip all components leads as short as possible to avoid any shorts to the enclosure on the underside of the board.
13. Install all connectors square and well-seated on the boards, to ensure when the boards are plugged together and installed in the enclosure, everything fits properly.
14. **Don't forget: QMX is supplied without firmware. Therefore at first power-up, you must install the latest firmware, a very simple procedure which is described in section 2.33.**

2.2 PCB diagrams (trace, component identification)

Subsequent pages show the trace and component identification diagrams for the various QMX PCBs. **Throughout this manual: some diagrams are Rev 2 etc. The only difference is that C504 in the Rev 4 is a 470uF 10V tantalum (not electrolytic).**

NOTE: Rev 2 LCD and SMPS boards are shown, which did not change for Rev 3 or Rev 4.
NOTE2: Rev 4 has a silkscreen error, it says "Rev 3" under the 2.1mm power connector.

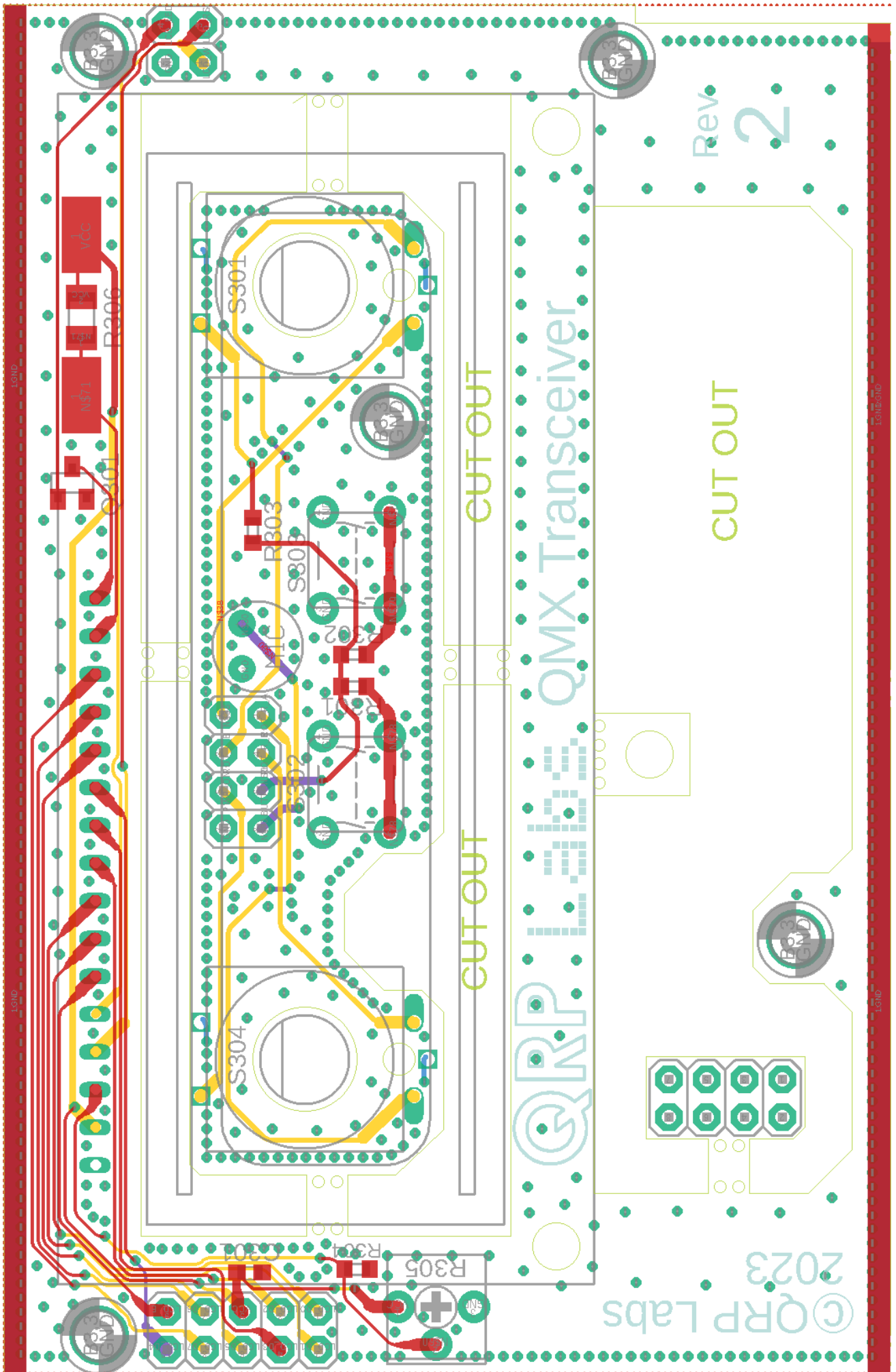

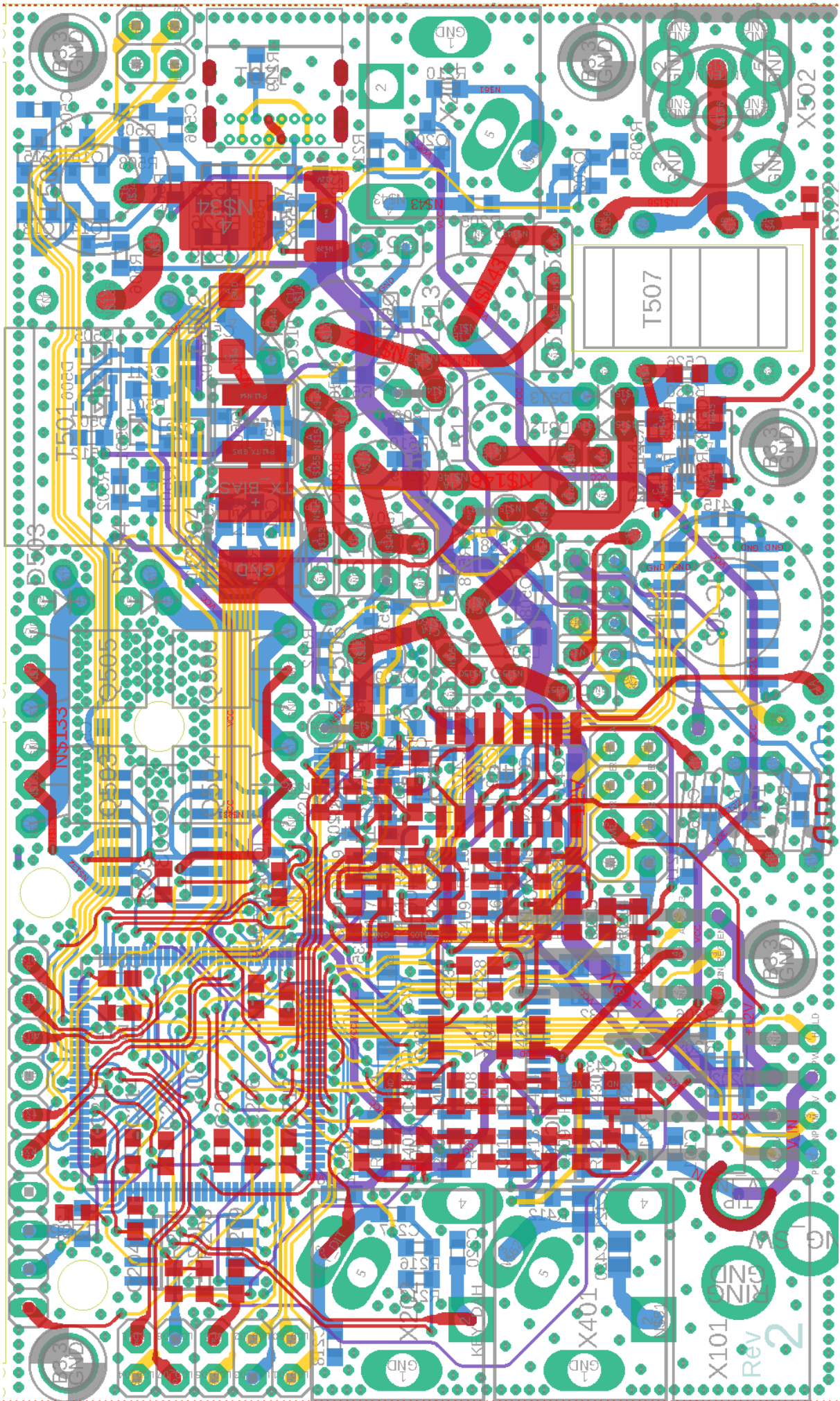

Trace layout:

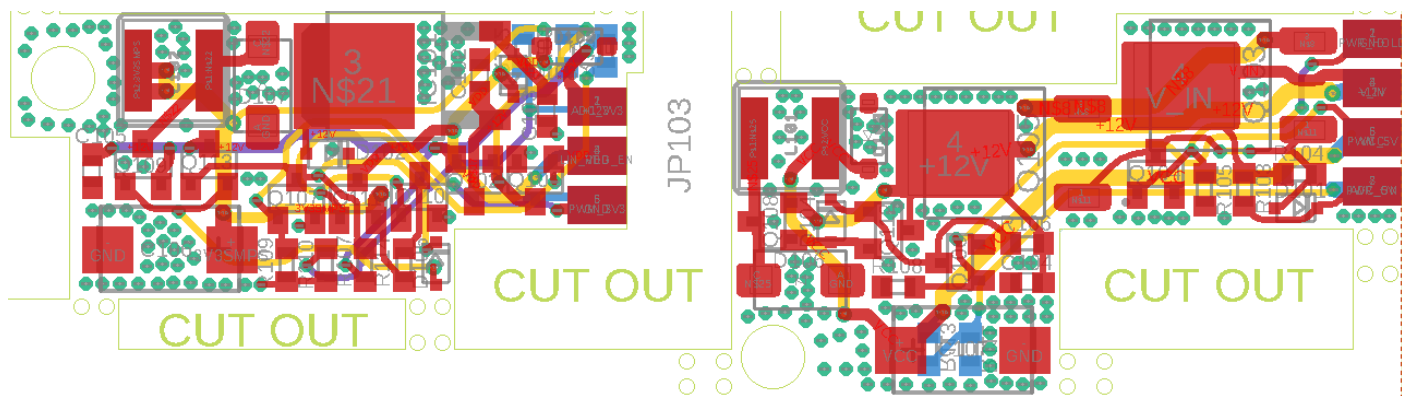

Top side components:

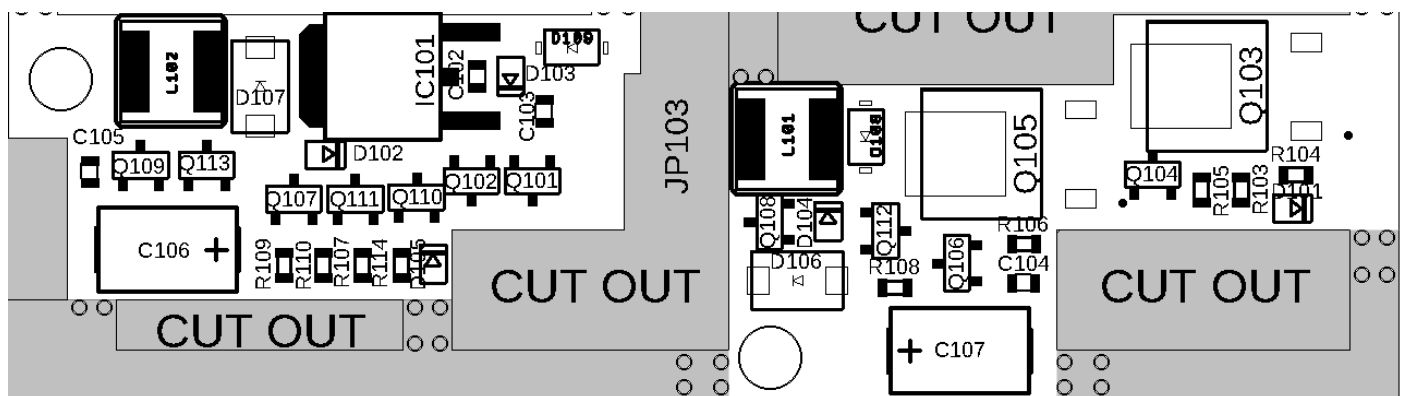

Bottom side components:

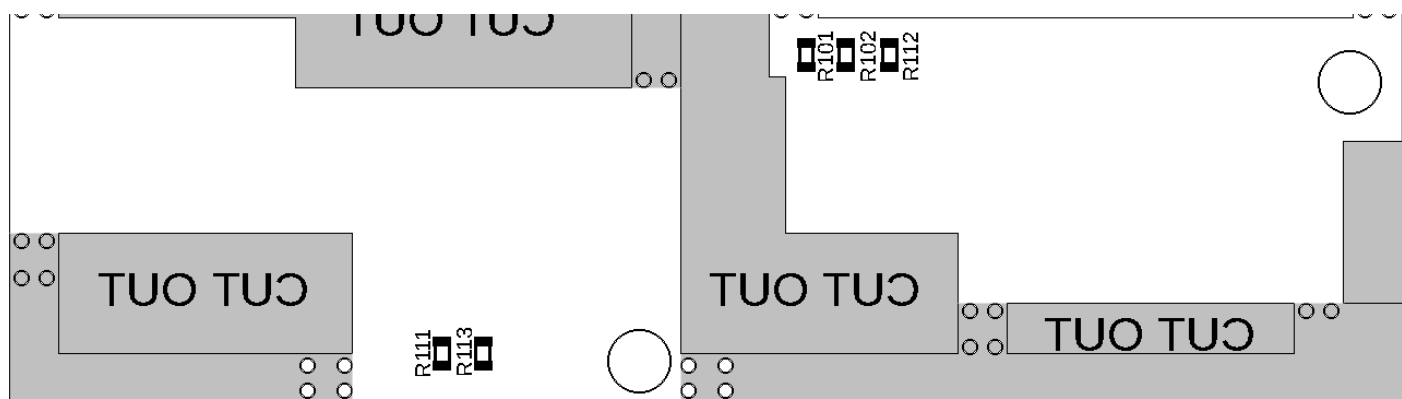

LCD and controls board are on the following page; there are no SMD components on the bottom side of these boards.

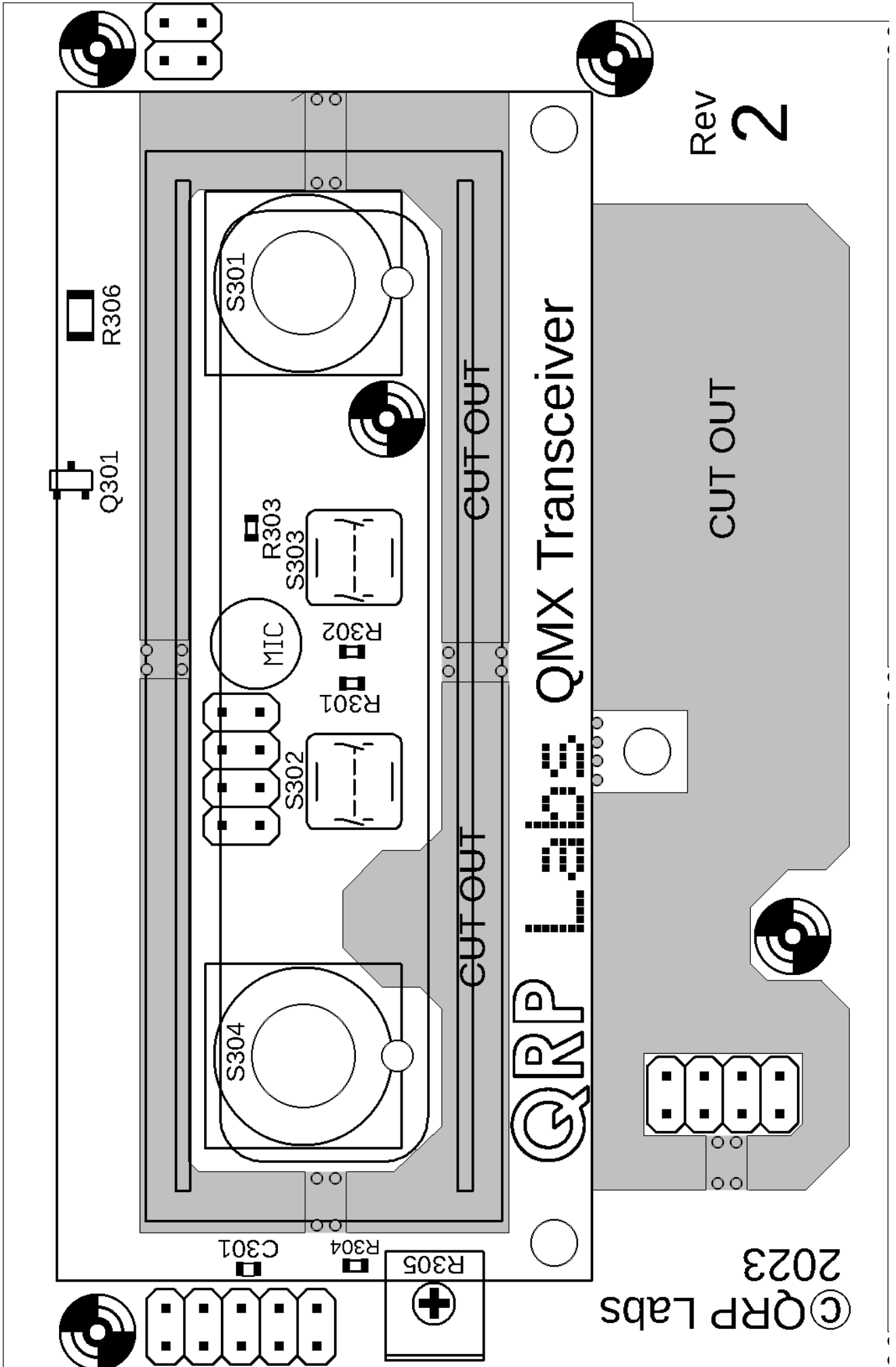

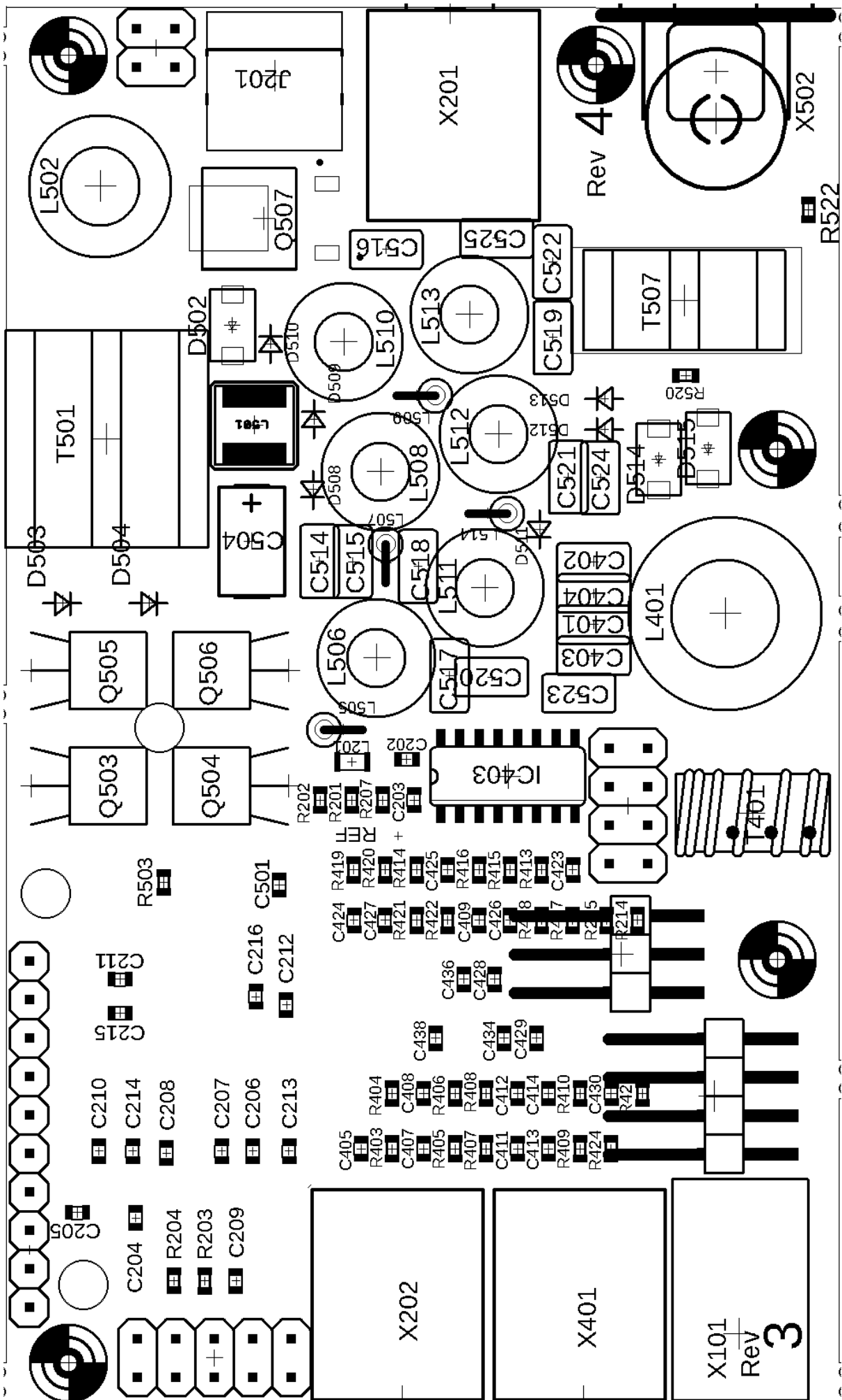

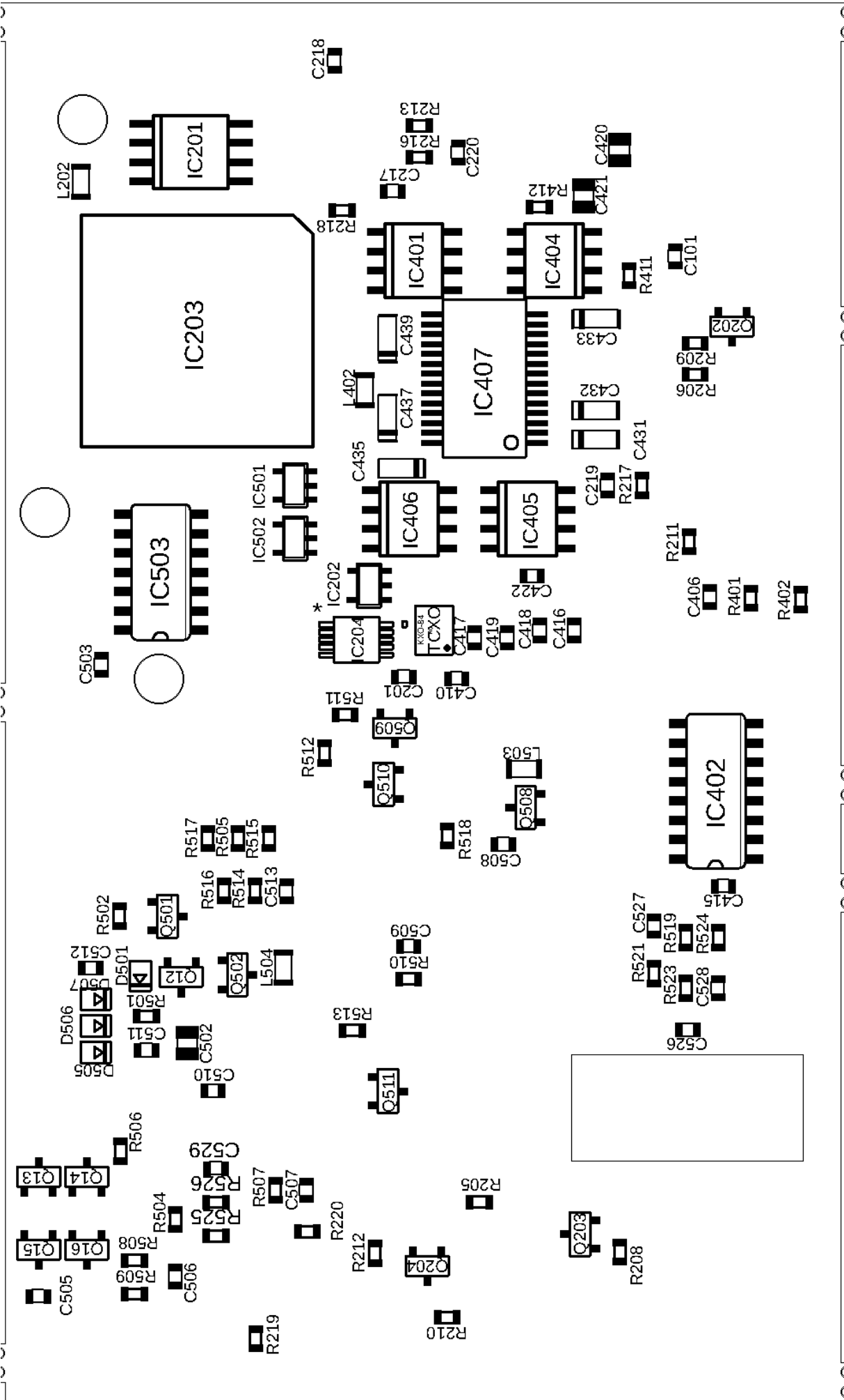

2.3 Parts list

Component nomenclature is by schematic sheet. Part numbers

- 1xx Power supply boards, schematic page 1
- 2xx Main board, CPU etc., schematic page 2
- 3xx LCD board and controls board, schematic page 3
- 4xx Main board, receiver section, schematic page 4
- 5xx Main board, transmitter section, schematic page 5

Many components are SMD, pre-soldered to the PCB in the factory. Only through-hole components need to be installed by the constructor. SMD components in the parts list are identified in the Description column and by the text colour being purple.

Resistors

Qty	Value	Description	Component numbers
14	100k	SMD 0603	R101, R103, R104, R105, R108, R109, R208, R209, R212, R502, R503, R518, R521, R523
18	10K	SMD 0603	R102, R106, R107, R204, R213, R214, R215, R216, R401, R402, R405, R406, R501, R505, R508, R519, R524, R526
7	22k	SMD 0603	R110, R111, R112, R113, R206, R423, R424
5	47-ohms	SMD 0603	R114, R415, R418, R419, R422
4	1k	SMD 0603	R201, R202, R515, R517
2	47k	SMD 0603	R203, R525
2	220-ohms	SMD 0603	R205, R210
5	470k	SMD 0603	R207, R510, R511, R512, R513
3	2.2k	SMD 0603	R211, R217, R218
4	3.3k	SMD 0603	R301, R304, R409, R410
1	6.8k	SMD 0603	R302
1	13k	SMD 0603	R303
1	33-ohms	SMD 1206	R306
2	267k	SMD 0603	R403, R404
2	560-ohms	SMD 0603	R407, R408
3	5.6k	SMD 0603	R411, R412, R507
2	100-ohms	SMD 0603	R413, R414
4	470-ohms	SMD 0603	R416, R417, R420, R421
4	5.1k	SMD 0603	R504, R506, R519, R520
1	1.91k	SMD 0603	R509
2	33-ohms	SMD 0603	R514, R516
2	49.9-ohms	SMD 0603	R520, R522
1	20K	TRIM3339P Trimmer	R305

Capacitors (50V, Multi-layer Ceramic capacitors except where indicated otherwise)
(see below for listing of band-version dependent inductors)

Qty	Value	Description	Component numbers
15	2.2u	SMD 0603	C101, C102, C103, C104, C105, C215, C216, C406, C407, C408, C413, C414, C430, C434, C510
3	470u	10V tantalum	C106, C107, C504
30	0.1u	SMD 0603	C201, C202, C203, C206, C207, C208, C209, C210, C211, C212, C214, C217, C219, C301, C409, C410, C415, C428, C429, C436, C438, C501, C503, C507, C508, C513, C526, C527, C528, C529
3	47n	SMD 0603	C205, C411, C412
3	1u	SMD 0603	C213, C405, C506
5	1n	SMD 0603	C204, C218, C220, C505, C509
4	33n	SMD 0603	C416, C417, C418, C419
3	10u	SMD 0805	C420, C421, C502
4	4.7n	SMD 0603	C422, C423, C424, C425
2	10n	SMD 0603	C426, C427
4	10u	Tantalum case A style	C431, C433, C435, C439
2	1u	Tantalum case A style	C432, C437
2	47p	SMD 0603	C511, C512

Semiconductors

Qty	Description	Component numbers
9	SMD: 1N4148 SOD323	D101, D102, D103, D104, D105, D501, D505, D506, D507
5	SMD: SS14 DO-214AC	D106, D107, D502, D514, D515
6	1N4007 diode	D508, D509, D510, D511, D512, D513
2	Unused diode	D503, D504
1	SMD: 5.6V 500mW SOD-123	D108
1	SMD: 3.6V 500mW SOD-123	D109
1	SMD: 78M05 TO252	IC101
1	SMD: 24M01 SOIC-8	IC201
1	SMD: SN74AHC1G00DBV	IC202
1	SMD: STM32F446VET6	IC203
1	SMD: MS5351M	IC204
1	SMD: CS4334 SOIC-8	IC401
2	SMD: 74CBT3253 SOIC-16	IC402, IC403
1	SMD: NE5532 SOIC-8	IC404
2	SMD: LM4562	IC405, IC406
1	SMD: PCM1804	IC407
2	SMD: 74AHC1G86DBV	IC501, IC502
1	SMD: 74ACT08 SOIC-14	IC503

Qty	Description	Component numbers
4	SMD: BSS84 MOSFET	Q102, Q202, Q204, Q502
12	SMD: BSS123 MOSFET	Q101, Q104, Q106, Q107, Q110, Q203, Q301, Q501, Q508, Q509, Q510, Q511
5	SMD: BC817 NPN SOT23-3	Q12, Q13, Q14, Q112, Q113
2	SMD: BC857 PNP SOT23-3	Q15, Q16
4	BS170: TO92 MOSFET	Q503, Q504, Q505, Q506
3	SMD: AO3415A SOT23-3	Q108, Q109, Q111
3	SMD: AOD403 (TO252)	Q103, Q105, Q507
1	SMD: 25MHz TCXO module	TCXO

Inductors

(see below for listing of band-version dependent inductors)

Qty	Description	Component numbers
5	SMD: 47uH L2012	L201, L202, L402, L503, L504
3	SMD: 330uH (CD54)	L101, L102, L501
4	47uH axial inductor	L505, L507, L509, L514
2	FT37-43	L502, T401
1	BN61-202 binocular, 3:3	T501
1	BN43-1502 binocular	T507

Miscellaneous

Qty	Value	Description
1	2.1 mm DC	2.1 x 5.5 barrel DC power connector
1	USB C	USB type C connector
1	BNC	Metal RF connector
3	3.5mm jack	3.5mm Stereo connector (PTT)
2	2x4	Pin header connector socket (female)
1	2x4	Pin header connector 90-degree plug (male)
1	2x3	Pin header connector socket (female)
1	2x3	Pin header connector 90-degree plug (male)
1	2x5	Pin header connector socket (female)
1	2x2	Pin header connector socket (female)
1	2x4	Pin header connector 17mm long plug (male)
1	2x2	Pin header connector plug (male)
1	2x5	Pin header connector plug (male)
1	PCB	Main PCB, 92 x 139.4 mm
1	1602 LCD	80x36mm HD44780 LCD module yellow/green
1	6mm Electret	Microphone
2	Rotary	Rotary encoder switch

Qty	Value	Description
2	6x6x8mm	Push-button switch
2	15mm	Knob
1	365 cm (80-20m version)	0.33 mm diameter wire (AWG #28) (varies depending on QMX version as noted)
1	65 cm (80-20m version)	0.60 mm diameter wire (AWG #22) (varies depending on QMX version as noted)
1	M3 10 mm	Steel 10mm long M3 screw
1	M3	Steel M3 nut
1	M3 12 mm	Steel 12mm diameter M3 washer
5	M3 x 11mm	Nylon threaded hex spacer
12	M3 x 6mm	Nylon screw
2	M3 x 9mm	Nylon screw
6	M3	Nylon nut

Enclosure (OPTIONAL)

Qty	Value	Description
1	Top	Extruded aluminium top, cut, drilled and laser-etched
1	Bottom	Extruded aluminium bottom
1	Left panel	Laser etched, drilled for three connectors
1	Right panel	Laser etched, drilled for three connectors
8	M2.5 machine screw	Screws to secure end panels
4	Rubber foot	Self-adhesive rubber foot

Frequency dependent parts:

80 / 60 / 40 / 30 / 20m version of QMX:

Capacitors (50V, Multi-layer Ceramic capacitors):

Qty	Value	Description	Component numbers
1	30pF	Label "300"	C401
2	56pF	Label "56J"	C521, C404
1	82pF	Label "820"	C522
1	100pF	Label "101"	C520
1	180pF	Label "181"	C516
1	220pF	Label "221"	C402
1	270pF	Label "271"	C525
2	390pF	Label "391"	C515, C524
2	470pF	Label "471"	C523, C519
2	820pF	Label "821"	C518, C514
1	1200pF	Label "122"	C517

Inductors (powdered iron Micrometals toroids):

Qty	Description	Component numbers
1	T30-6 toroid (yel), 2.40 uH (26t)	L511
1	T30-6 toroid (yel), 2.88 uH (28t)	L506
1	T30-6 toroid (yel), 1.06 uH (17t)	L512
1	T30-6 toroid (yel), 394 nH (10t)	L513
1	T30-6 toroid (yel), 1.20 uH (18t)	L508
1	T30-6 toroid (yel), 525 nH (12t)	L510
1	T50-2 toroid (red) – tapped, see text	L401

60 / 40 / 30 / 20 / 17 / 15m version of QMX:

Capacitors (50V, Multi-layer Ceramic capacitors):

Qty	Value	Description	Component numbers
1	33pF	Label "330" or "33J"	C522
1	39pF	Label "390" or "39J"	C403
2	56pF	Label "560" or "56J"	C401, C520
1	82pF	Label "820" or "82J"	C521
1	150pF	Label "151"	C404
1	180pF	Label "181"	C515
2	220pF	Label "221"	C402, C516
2	270pF	Label "271"	C524, C525
2	390pF	Label "391"	C514, C523
1	470pF	Label "471"	C518
1	560pF	Label "561"	C519
1	820pF	Label "821"	C517

Inductors (powdered iron Micrometals toroids):

Qty	Description	Component numbers
1	T30-17 toroid (yel/blue), 1.06 uH (26t)	L511
1	T30-17 toroid (yel/blue), 1.20 uH (27t)	L506
1	T30-17 toroid (yel/blue), 393 nH (16t)	L512
1	T30-17 toroid (yel/blue), 230 nH (12t)	L513
1	T30-17 toroid (yel/blue), 525 nH (18t)	L508
1	T30-17 toroid (yel/blue), 286 nH (11t)	L510
2	T37-6 toroid (yel) – tapped, see text	L401a, L401b

Note: L401 in the 60-15m version consists of two T37-6 toroids in place of the normal larger T50-2 (80-20m version) or T50-6 (20-10m version) – see explanation later.

Capacitors (50V, Multi-layer Ceramic capacitors):

Qty	Value	Description	Component numbers
1	15pF	Label "150" or "15J"	C522
1	22pF	Label "220" or "22J"	C520
1	30pF	Label "300" or "30J"	C403
3	33pF	Label "330" or "33J"	C401, C404, C521
1	56pF	Label "560" or "56J"	C402
1	82pF	Label "820" or "82J"	C525
1	100pF	Label "101"	C516
2	120pF	Label "121"	C514, C523
1	180pF	Label "181"	C519
1	220pF	Label "221"	C515
2	270pF	Label "271"	C517, C524
1	560pF	Label "561"	C518

Inductors (powdered iron Micrometals toroids):

Qty	Description	Component numbers
1	T30-17 toroid (yel/blue), 640 nH (20t)	L511
1	T30-17 toroid (yel/blue), 706 nH (21t)	L506
1	T30-17 toroid (yel/blue), 230 nH (12t)	L512
1	T30-17 toroid (yel/blue), 270 nH (13t)	L513
1	T30-17 toroid (yel/blue), 286 uH (13t)	L508
1	T30-17 toroid (yel/blue), 314 nH (14t)	L510
1	T50-6 toroid (yel) – tapped, see text	L401

Note: Photo shows parts for 80/60/40/30/20m version of the QMX.

Note: Capacitor colours vary depending on availability. All are NP0/C0G Class-I RF dielectric.

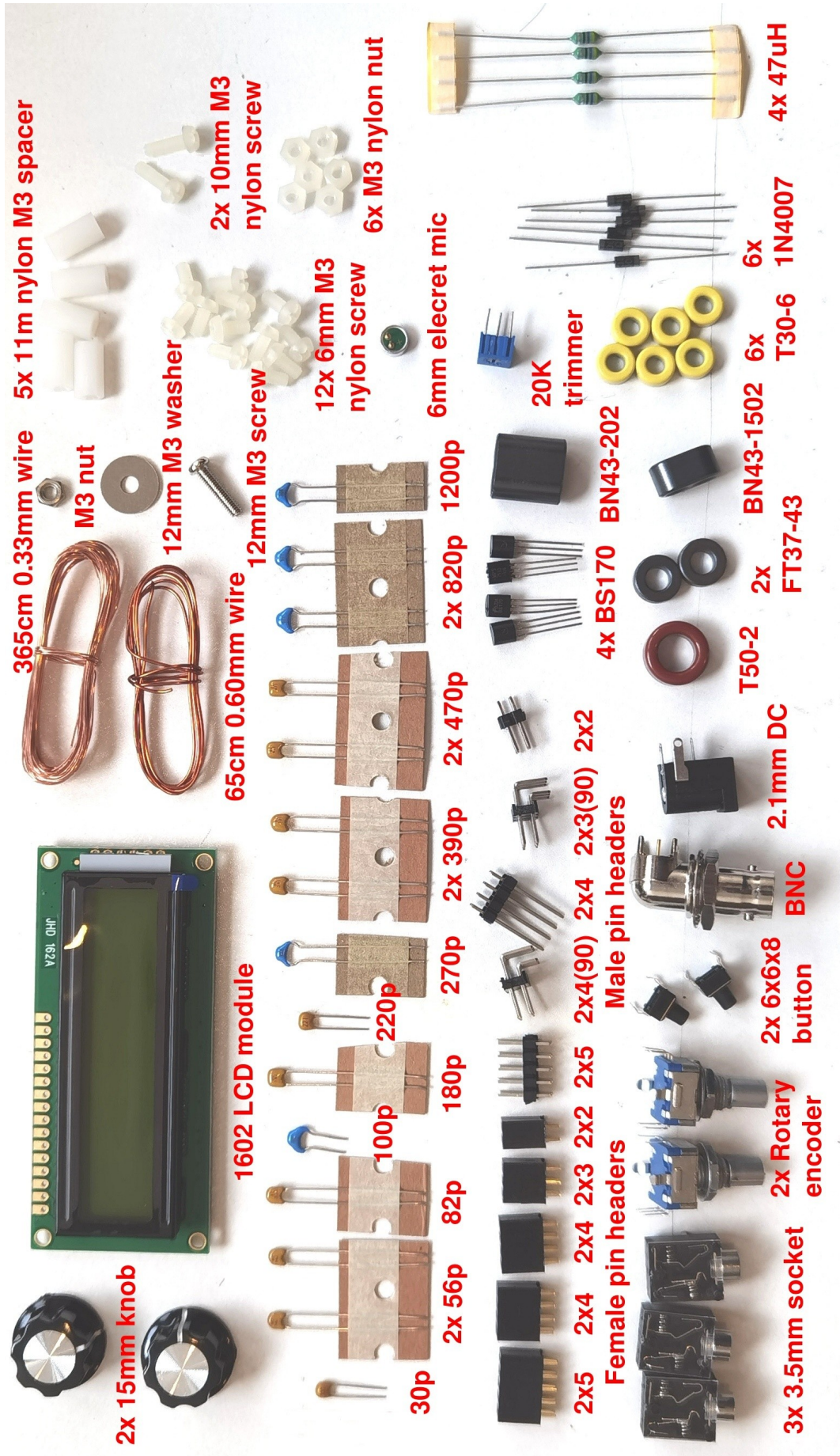

2.5 Install all the ceramic capacitors

80 / 60 / 40 / 30 / 20m version: Install all 15 through-hole capacitors in accordance with the following diagram. The procedure is so easy that I have included all capacitors in a single assembly step rather than doing one diagram for each capacitor value. Nevertheless be very careful to insert the correct value capacitors in the correct places. Mistakes are hard to correct later. NOTE: the 22pF capacitor – if supplied - (“220”) is not used.

In the diagram, the component label (capacitor body inscription) is written inside the capacitor body, which **may be supplied coloured yellow, or blue, according to availability**. The actual value e.g. 56p is written in red text next to the capacitor. Note that the leads of some capacitors may need to be bent to fit the 2.5mm-spaced holes.

Be careful not to damage nearby SMD components when soldering or clipping the capacitor leads. Also note that ground pin connections require a LOT more heat to achieve a good joint. Ensure C525 does not overlap the outline of the adjacent connector – or leave it for later.

Qty	Value	Description	Component numbers
2	470pF	Through-hole, label “471”	C523, C519
2	390pF	Through-hole, label “391”	C515, C524
1	270pF	Through-hole, label “271”	C525
1	100pF	Through-hole, label “101”	C520
2	56pF	Through-hole, label “56J” or “560”	C521, C404
1	82pF	Through-hole, label “82J” or “820”	C522
1	1200pF	Through-hole, label “122”	C517
2	820pF	Through-hole, label “821”	C518, 514
1	180pF	Through-hole, label “181”	C516
1	None	Capacitor not fitted	C403
1	220pF	Through-hole, label “221”	C402
1	30pF	Through-hole, label “300” or “30J”	C401

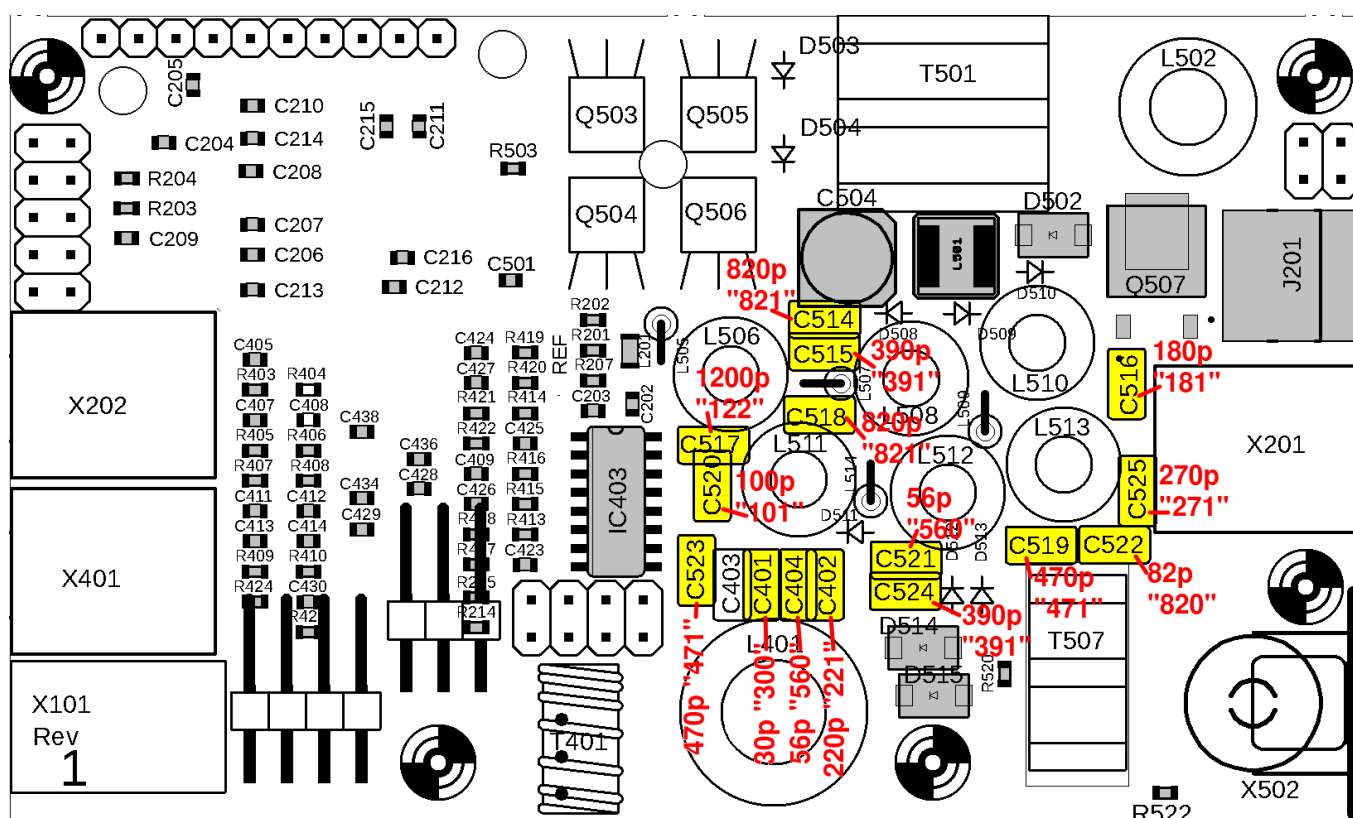

20 / 17 / 15 / 12 / 11 / 10m version: Install all 16 through-hole capacitors in accordance with the following diagram. The procedure is so easy that I have included all capacitors in a single assembly step rather than doing one diagram for each capacitor value. Nevertheless be very careful to insert the correct value capacitors in the correct places. Mistakes are hard to correct later.

In the diagram, the component label (capacitor body inscription) is written inside the capacitor body, which **may be supplied coloured yellow, or blue, according to availability**. The actual value e.g. 33p is written in red text next to the capacitor. Note that the leads of some capacitors may need to be bent to fit the 2.5mm-spaced holes.

Be careful not to damage nearby SMD components when soldering or clipping the capacitor leads. Also note that ground pin connections require a LOT more heat to achieve a good joint. Ensure C525 does not overlap the outline of the adjacent connector – or leave it for later.

Qty	Value	Description	Component numbers
1	15pF	Through-hole, label "150" or "15J"	C522
1	22pF	Through-hole, label "220" or "22J"	C520
1	30pF	Through-hole, label "300" or "30J"	C403
3	33pF	Through-hole, label "330" or "33J"	C401, C404, C521
1	56pF	Through-hole, label "560" or "56J"	C402
1	82pF	Through-hole, label "820" or "82J"	C525
1	100pF	Through-hole, label "101"	C516
2	120pF	Through-hole, label "121"	C514, C523
1	180pF	Through-hole, label "181"	C519
1	220pF	Through-hole, label "221"	C515
2	270pF	Through-hole, label "271"	C517, C524
1	560pF	Through-hole, label "561"	C518

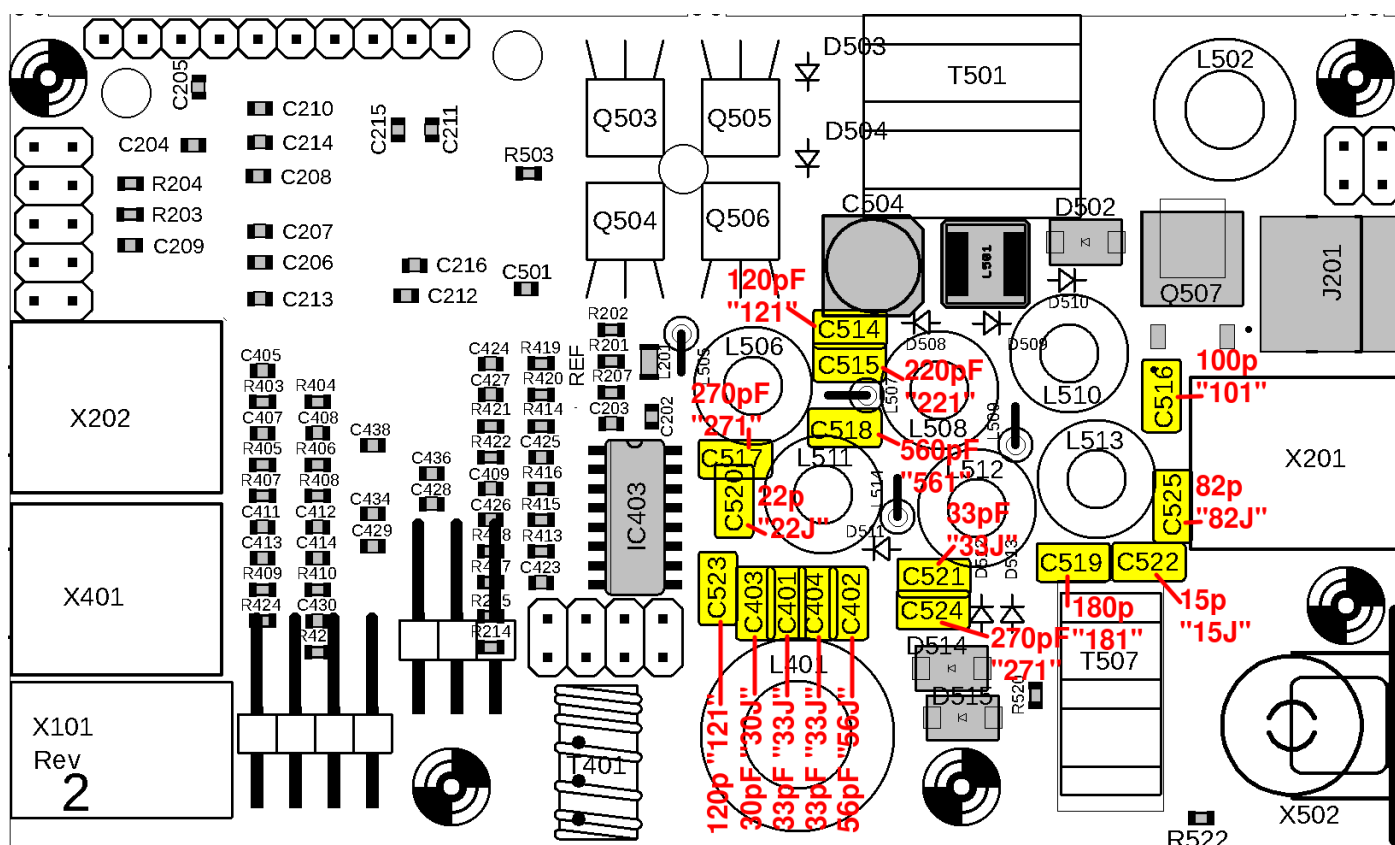

2.6 Install 1N4007 diodes

Install the six 1N4007 diodes D508-D513.

Pay attention to the orientation of the diodes which is critically important. The diodes have a black body and a white stripe. The PCB silkscreen arrows point towards the white stripe (diode cathode) end.

The white stripe end must be aligned with the white stripe on the image on the PCB silkscreen. The end with the white stripe is shown with a blue dot in the diagram below. For D508 & D511 the white stripe is in the left hole; for D509 & D510, the white stripe is in the right hole; for D512 & D513 the white stripe is in the top hole. Bend one lead over 180-degrees so that the diode body stands up vertically at 90-degrees to the PCB.

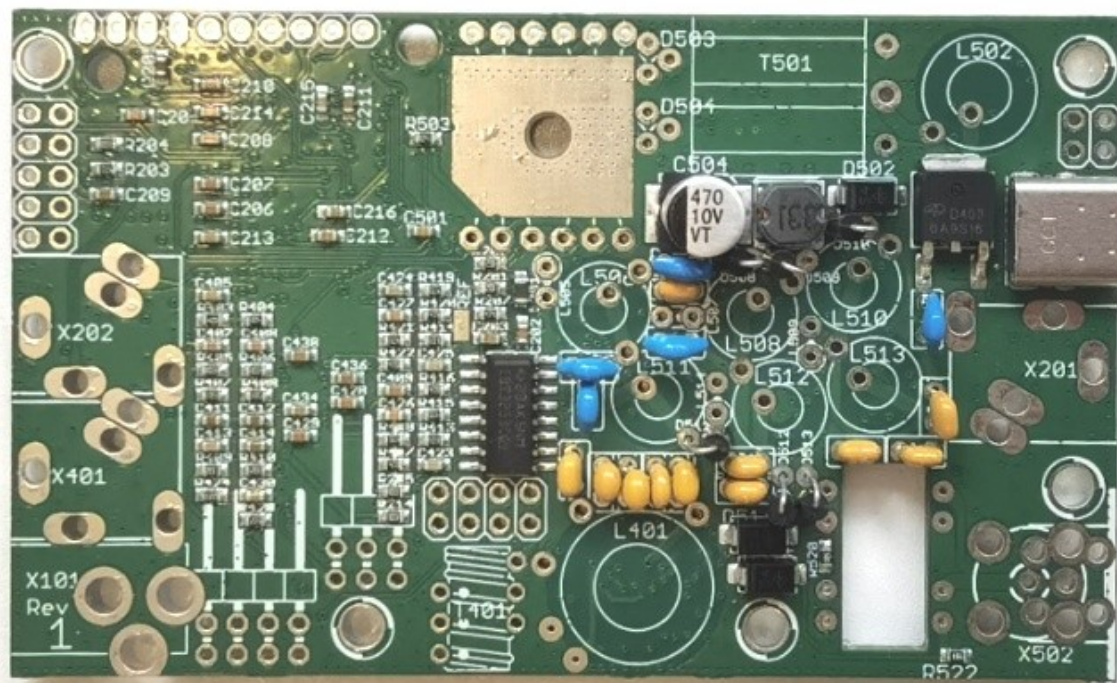
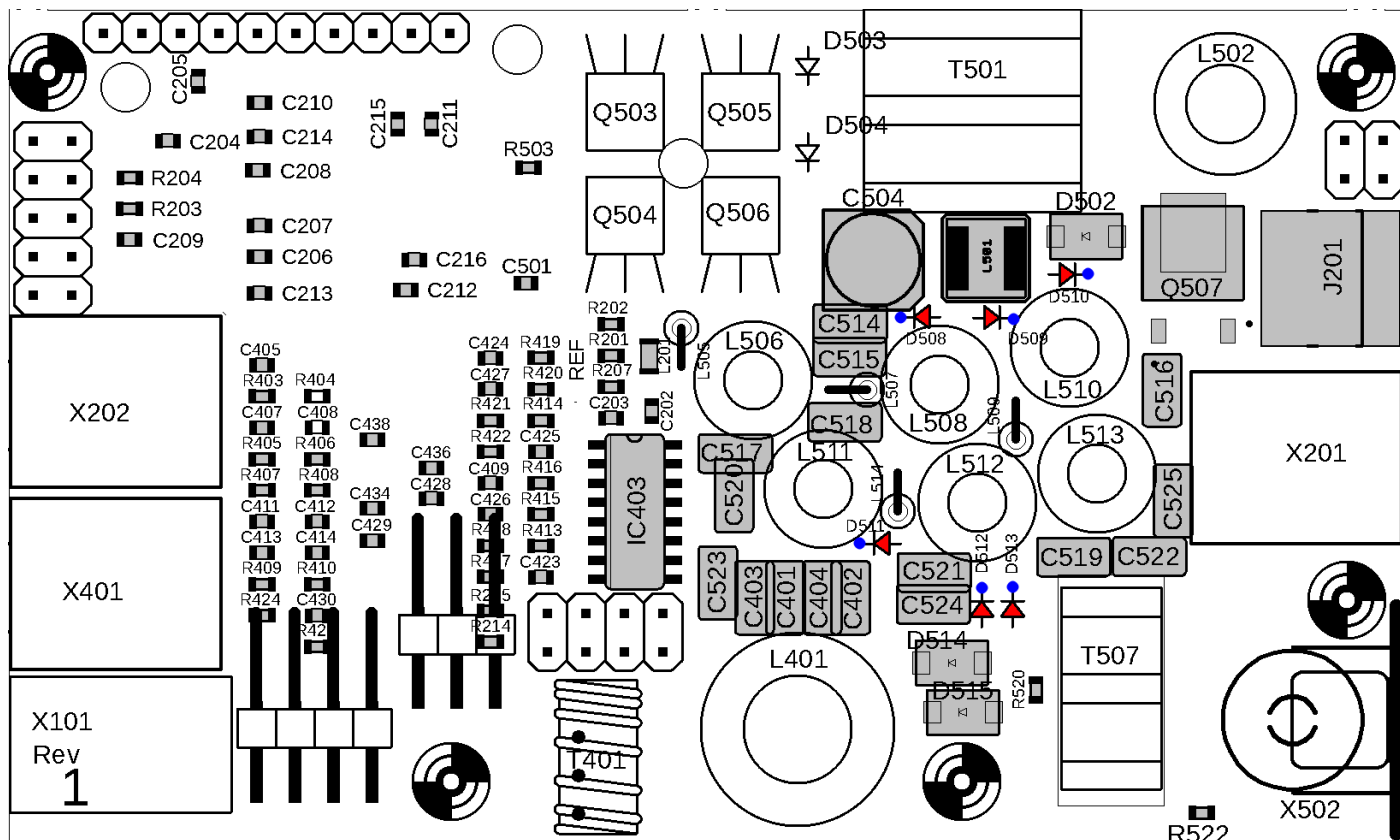
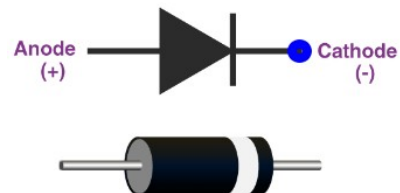

2.7 Install 47uH inductors

Install the four 47uH axial inductors L505, L507, L509, and L514. Bend one lead over 180-degrees so that the inductor body stands up vertically at 90-degrees to the PCB.

The orientation of these is not particularly important, but my recommendation is to follow the silkscreen PCB pattern, putting the body (longer lead) nearer to the PCB lower edge (as orientated in the diagram below) and the wire (shorter lead) nearer to the top side.

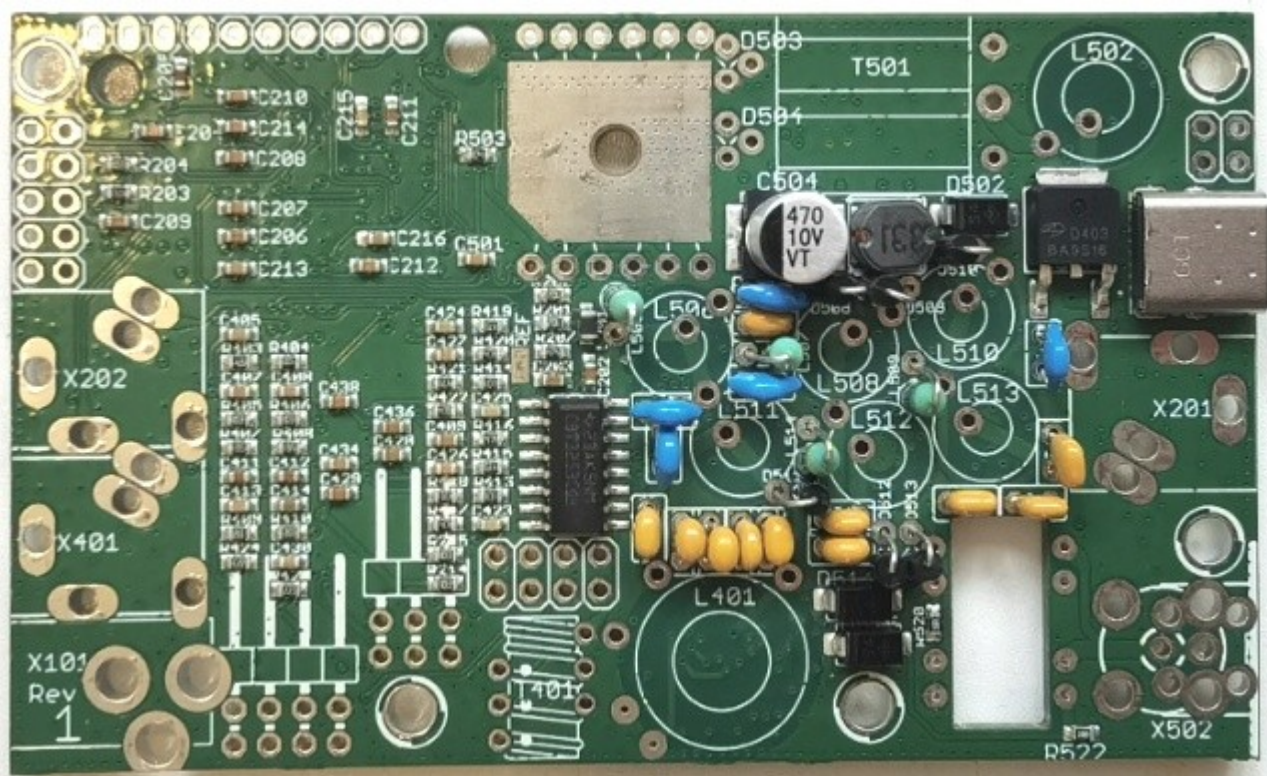
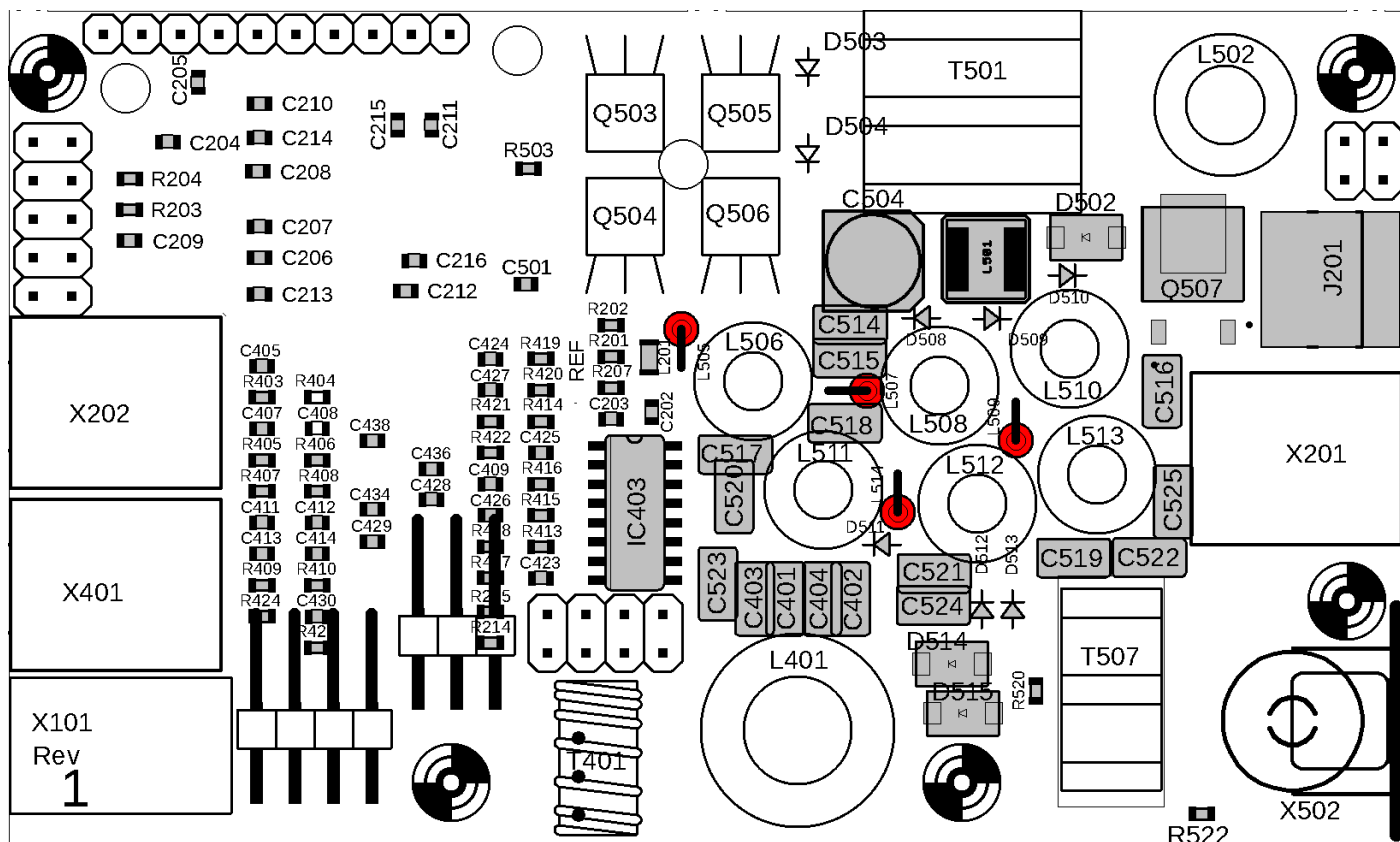

2.8 Install BS170 PA transistors

Install the BS170 transistors in the positions shown, with their flat faces flush against the PCB.

Use the 10mm M3 bolt, washer and nut to firmly press the transistor faces against the PCB, as shown.

Refer to the diagram and photographs below.

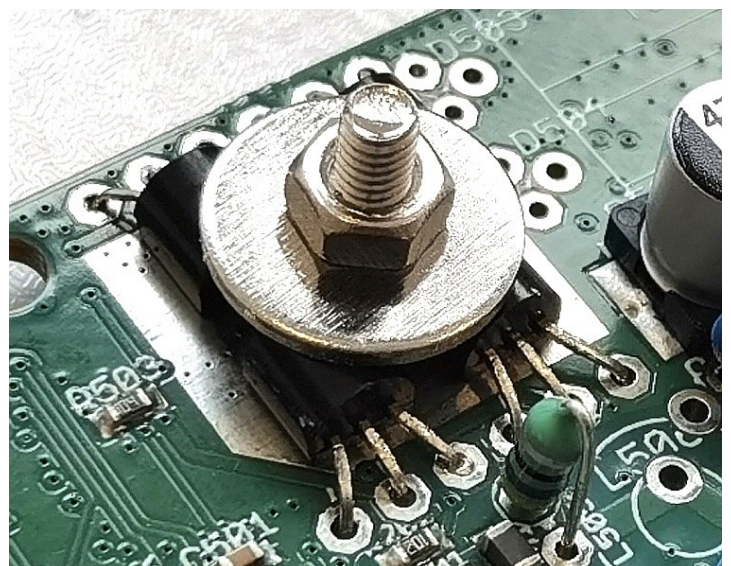
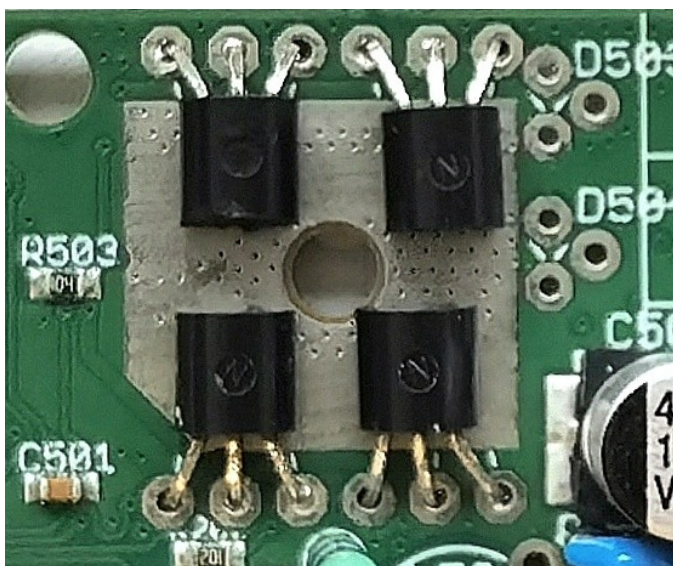
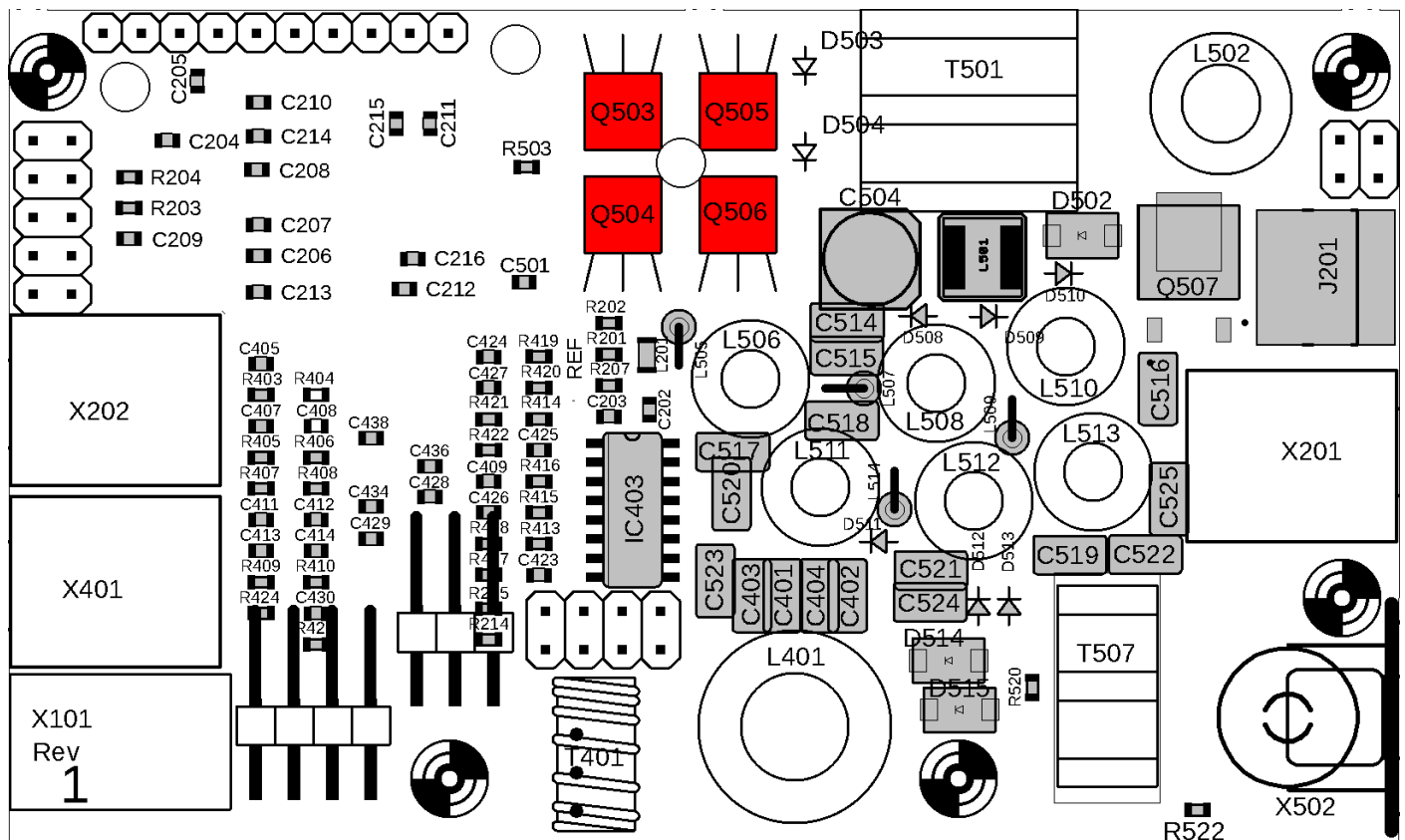

NOTE: Photographs in steps 12, 13, 14, 15 and 17 (on this page only) are from the QDX kit, but the principles are the same!

Step 14: Solder the four wire endings. At each pad, hold the soldering iron firmly, apply plenty of solder, and wait for about 10 seconds. This will ensure a good connection, and any remaining enamel will be burned away.

Step 15: Finally repeat the procedure with the two center-tap wires that came through the large center hole. Scrape them, cut them to 2mm, and solder them. Apply plenty of solder and hold the soldering iron tip to the joint for maybe 15 seconds, to really be sure of a good joint and burning away any remaining enamel.

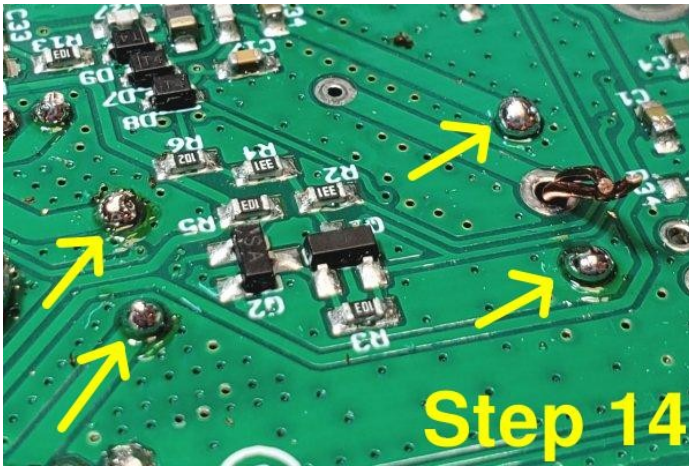

Step 16: Check that none of the wires protrude more than 2mm from the surface of the PCB, since if you are using the optional aluminium enclosure, there are only a few mm clearance.

Step 17: Verify good connections for all five soldered joints of T501 using a DMM set to resistance or continuity mode. My cheap DMM hasn't got a continuity mode and I'm using the 2000-ohm resistance mode; in this mode when there is continuity, the reading on mine shows 001 (not zero-ohms; this is just a DMM thing, of no significance).



You should see continuity between all the points labeled A in the photo below. Touch the probes to pairs of these points, to verify continuity.

You should see continuity between the points labeled B also. Touch the two probes to the two pads labeled B and check for continuity.

Finally, there should be NO connection between A and B. Hold one probe on any A point and the other probe on a B point. That should read infinite resistance (no continuity).

If any of these tests fail, then you have a soldering problem somewhere, or the wrong wire in the wrong hole, or some short-circuit somewhere etc.

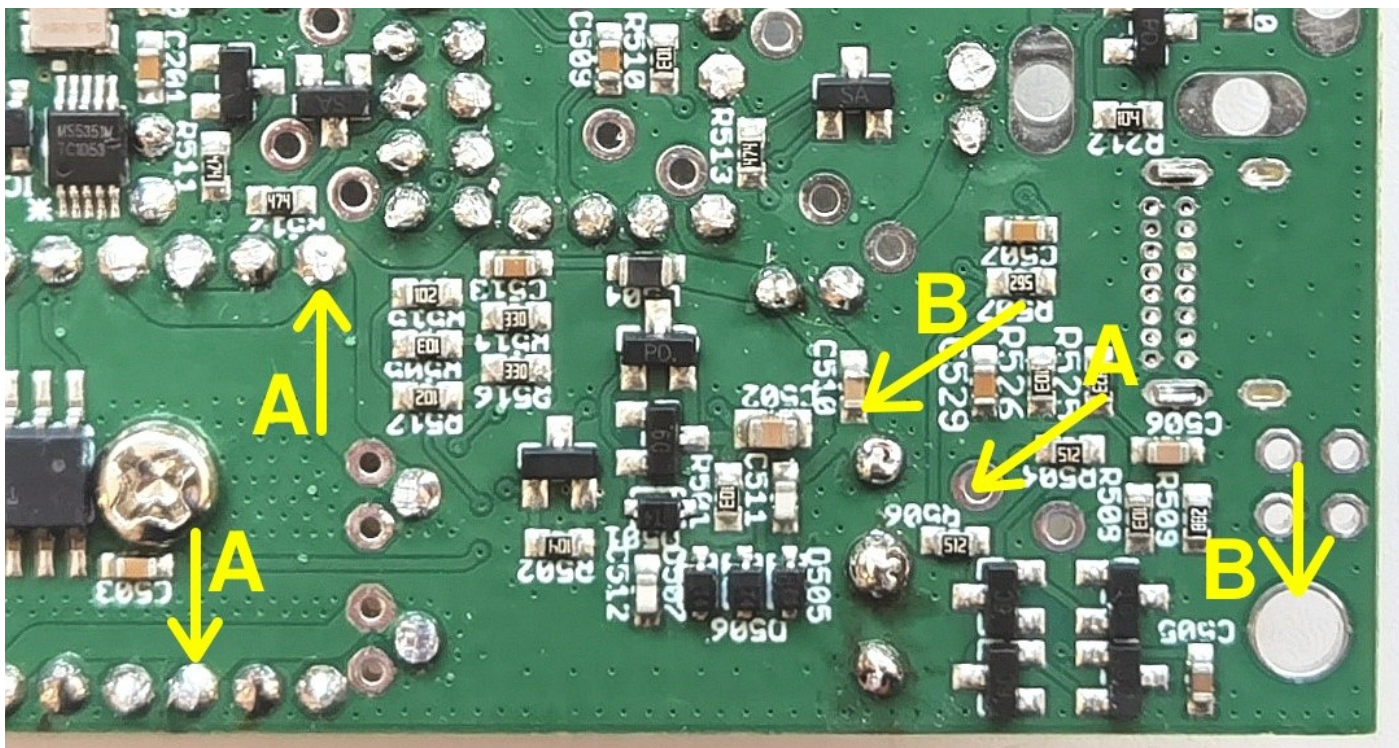

This is the final appearance of T501 when the installation is complete:

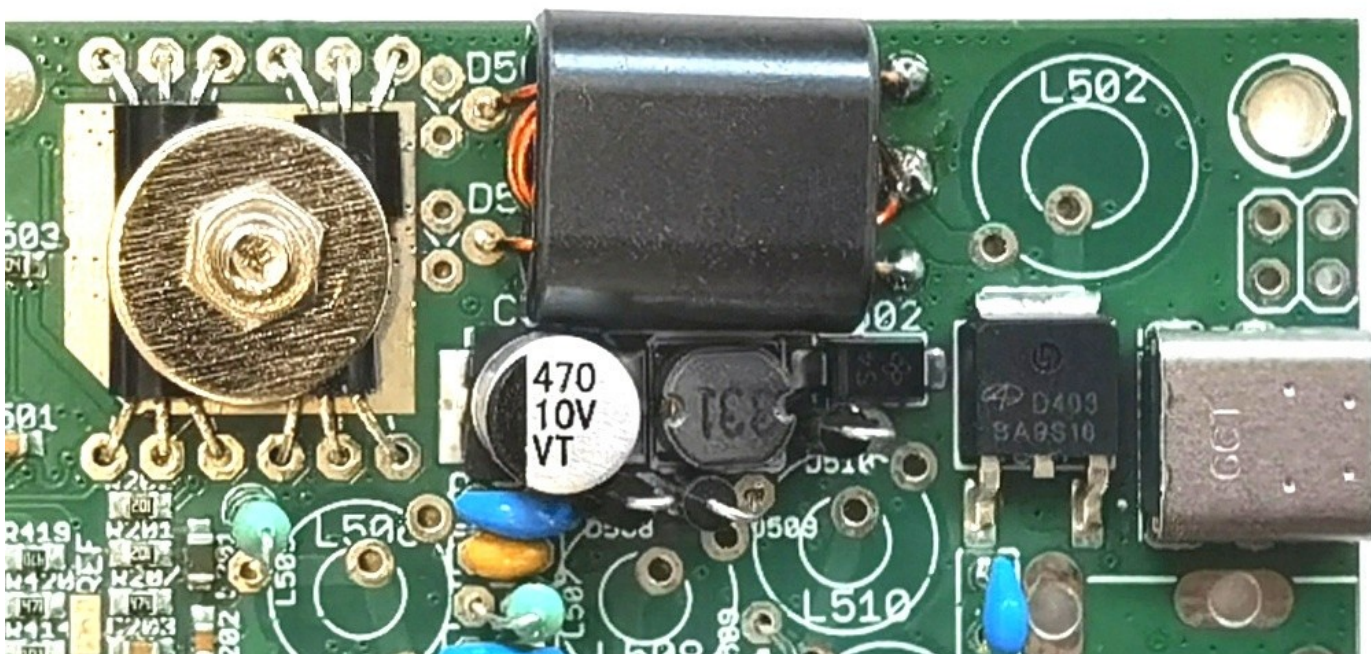

2.10 Prepare and install tapped inductor L401

80 / 60 / 40 / 30 / 20m version: L401 is an inductor wound on a T50-2 toroid (red colour, large size), having several taps which are switched in according to the operating frequency (band). There are 23 turns in total, with a tap at 15 turns. The diagram shows the location of the tap at 15 turns, which has a larger hole, such that two wires can be inserted. NO wire is soldered into the hole marked X. The two holes labelled 23 are to be jumpered together with a wire; the end of the 23 turn winding is inserted into the smaller of these two holes, along with a jumper wire making the connection to the other (larger) "23" hole. It's best to use a piece of capacitor offset wire for the jumper wire.

Carefully unwind and cut off approximately 45cm of the 0.33mm (AWG #28) enameled wire, and straighten it, ensuring no kinks.

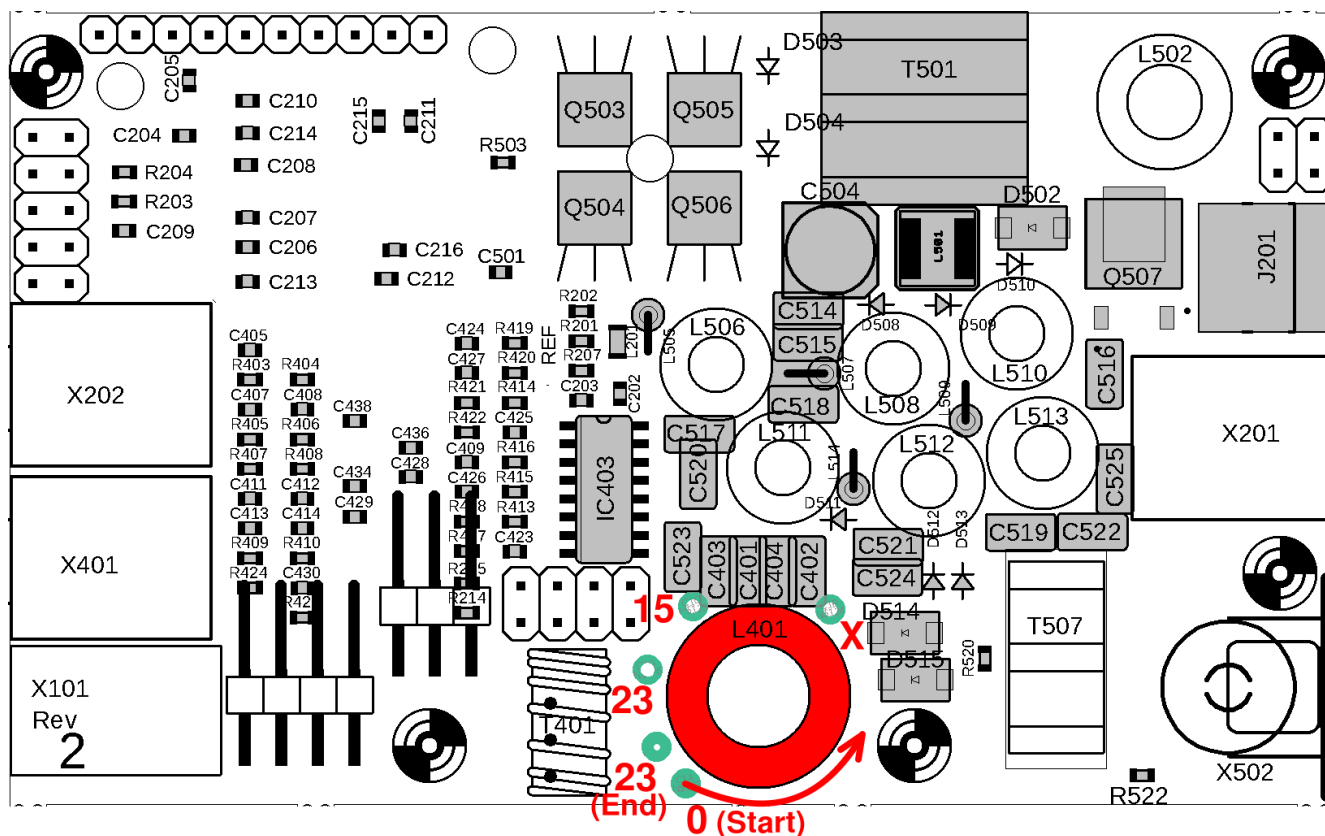

Step 1: Begin winding L401 as shown. Remember that in the nomenclature of toroidal inductors, each time the wire passes through the center of the toroid counts as 1 turn.

Step 2: Wind 15 turns then make a 2cm loop between the 15th and 16th turns. This is for the 15 turn tap.

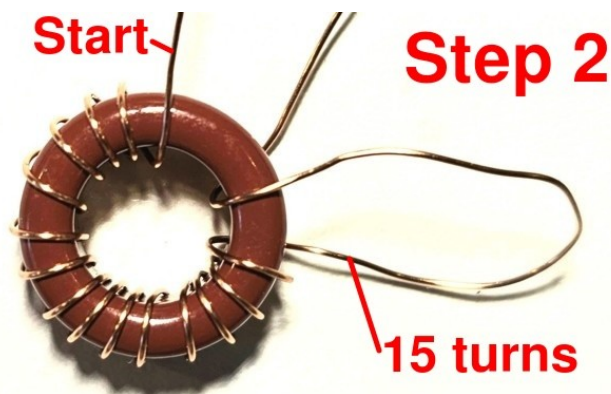
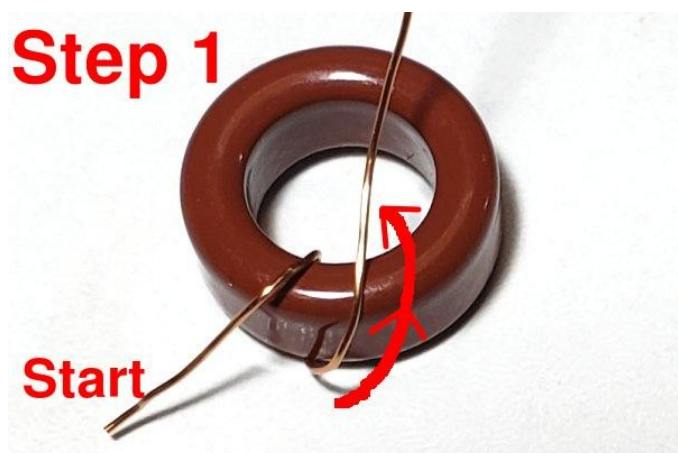

Step 3: Wind up to the 23th turn end of the winding.

Step 4: Now with a pair of pliers, squeeze the 15-turn tap loop into a sharp point, such that it is easy to fit through the large hole for the 15 turn tap (refer to diagram, previous page).

Step 5: Insert the start end of the wire winding in the start hole, the 15 turn tap (sharp squeezed loop) in the appropriate 15t hole, and the end winding in the “23t (End)” hole. Leave the hole labeled “23t” empty for now. And of course leave the “No Connection” hole empty.

(see photo, below).

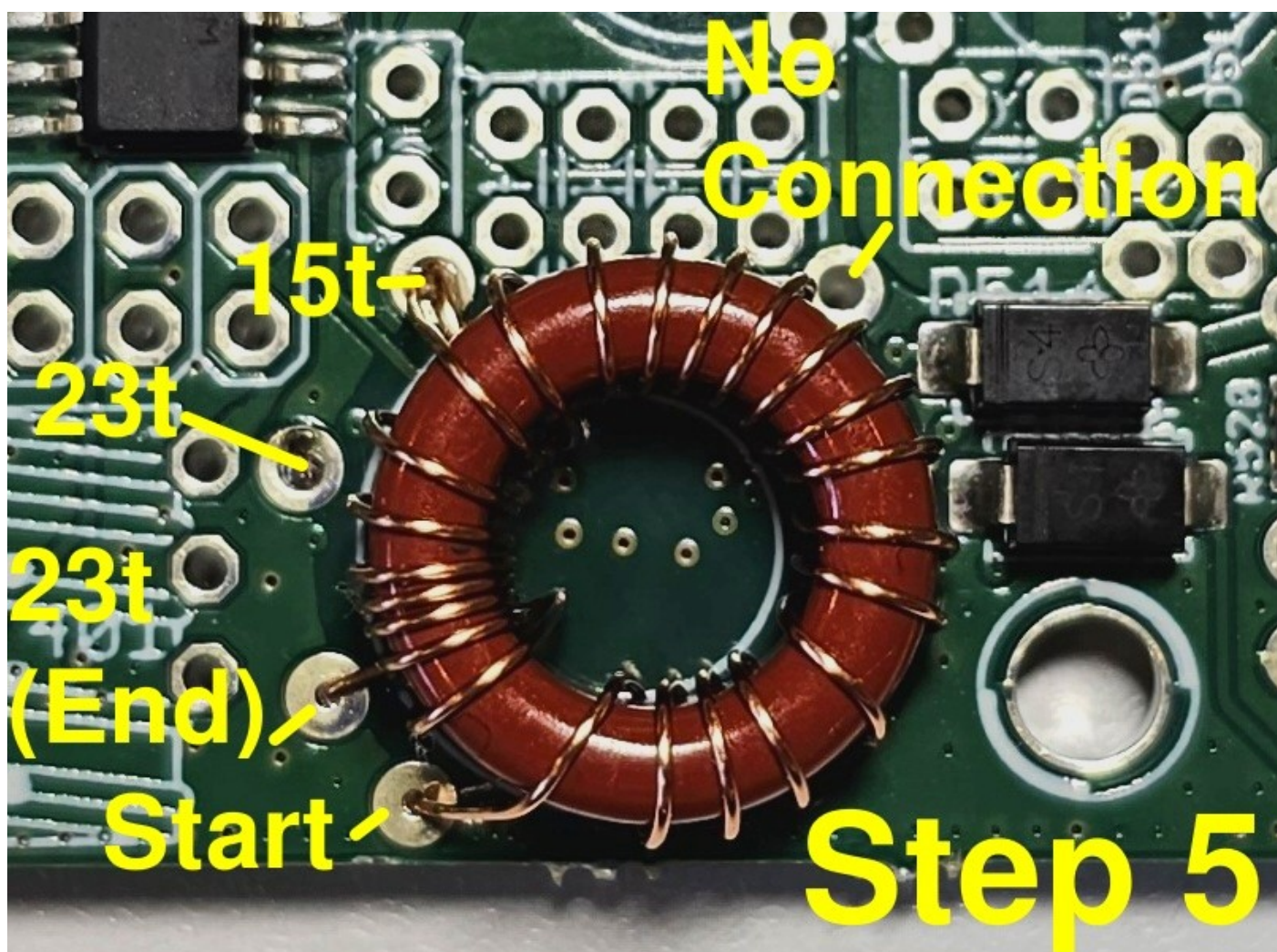
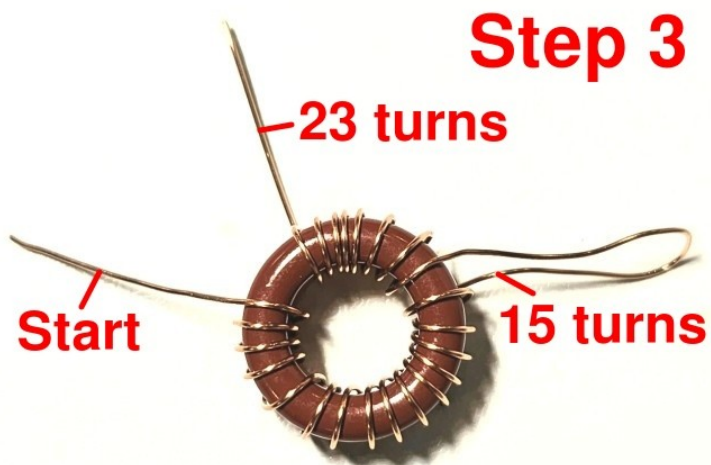

Step 6: You should pull them firmly from the underside of the board to ensure that there are no loose wires on the top side.

Now cut each wire to about 2mm length (at most) and solder in place. It is essential to remove the enamel from the wire. My favourite method of doing this is simply to hold the soldering iron to the joint, with plenty of solder, for at least 10 seconds. The enamel burns away in this time.

An alternative method is to scrape the wire.

Step 7: Add an offcut from a capacitor wire to make the connection on the underside of the board between the hole labeled “23t” and the one labeled “23t (End)”.

Step 8: Verify the joints are properly soldered, by using a DMM in continuity testing mode (if it has this mode) or check for zero ohms in resistance mode. On the reverse of the PCB, check for continuity between points labeled A, B, C, D as shown. You should measure 0 ohms (continuity) between any pairs of these. If you do not, then there is a mistake somewhere, most probably a failure to burn away the enamel at one or more of the L401 connections to make a good joint.

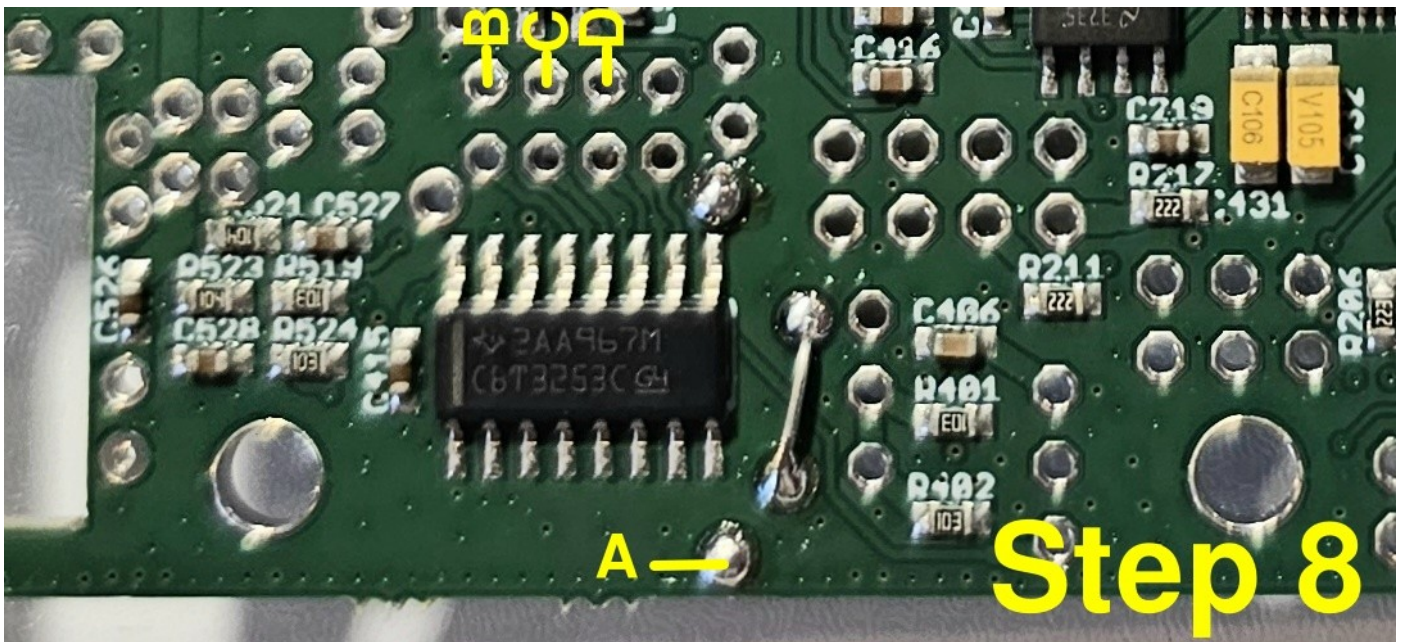
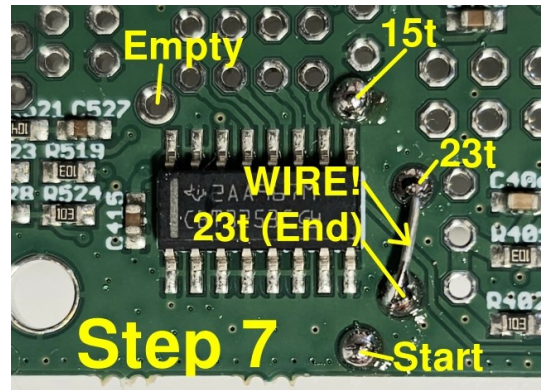

Here's the story so far, including the nicely installed L401 tapped inductor (Note: shows old-style L401 winding; ignore that, the winding is as per the above instructions).

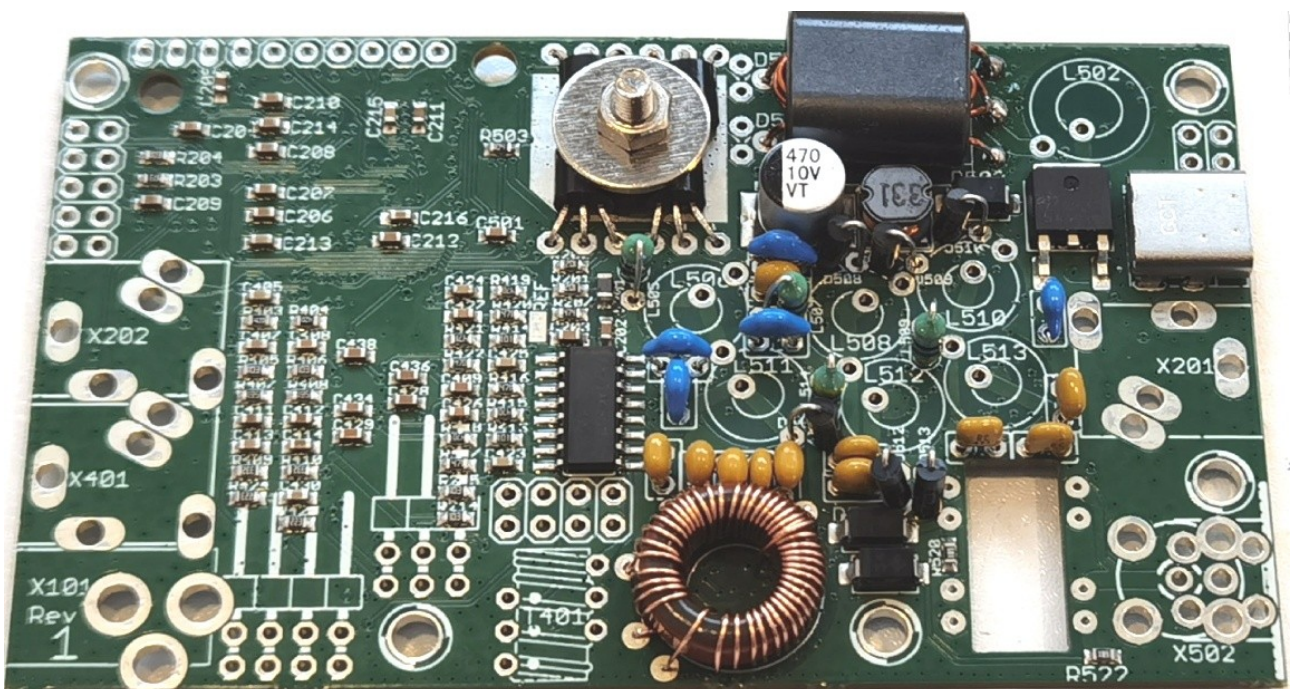

60 / 40 / 30 / 20 / 17 / 15m version: L401 is broken into two separate toroids, each T37-6, which are called L401a and L401b. The reason for splitting it into two toroids is that it avoids unwanted resonances caused by parasitic component values – which arise because of the unselected coil taps and the series capacitors, in conjunction with the small “Off” capacitance of deselected multiplexer (IC402) pins. IC402 selects the appropriate coil and coil tap according to the operating frequency (band). With all due apologies for the handdrawn schematic fragment, the 60-15m band pass configuration is like this >

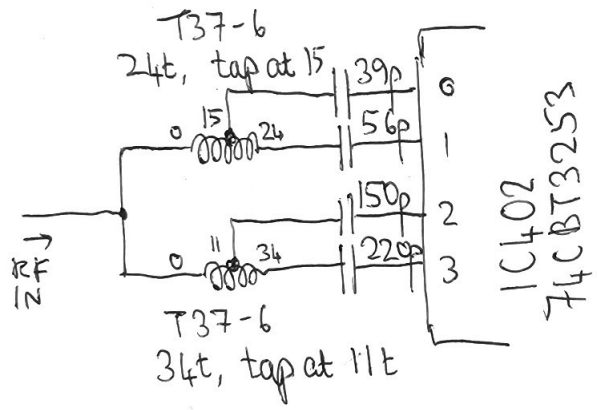

The two toroids are installed vertically, as shown below; despite the compact nature of QMX there is enough spare space under the controls board at this location.

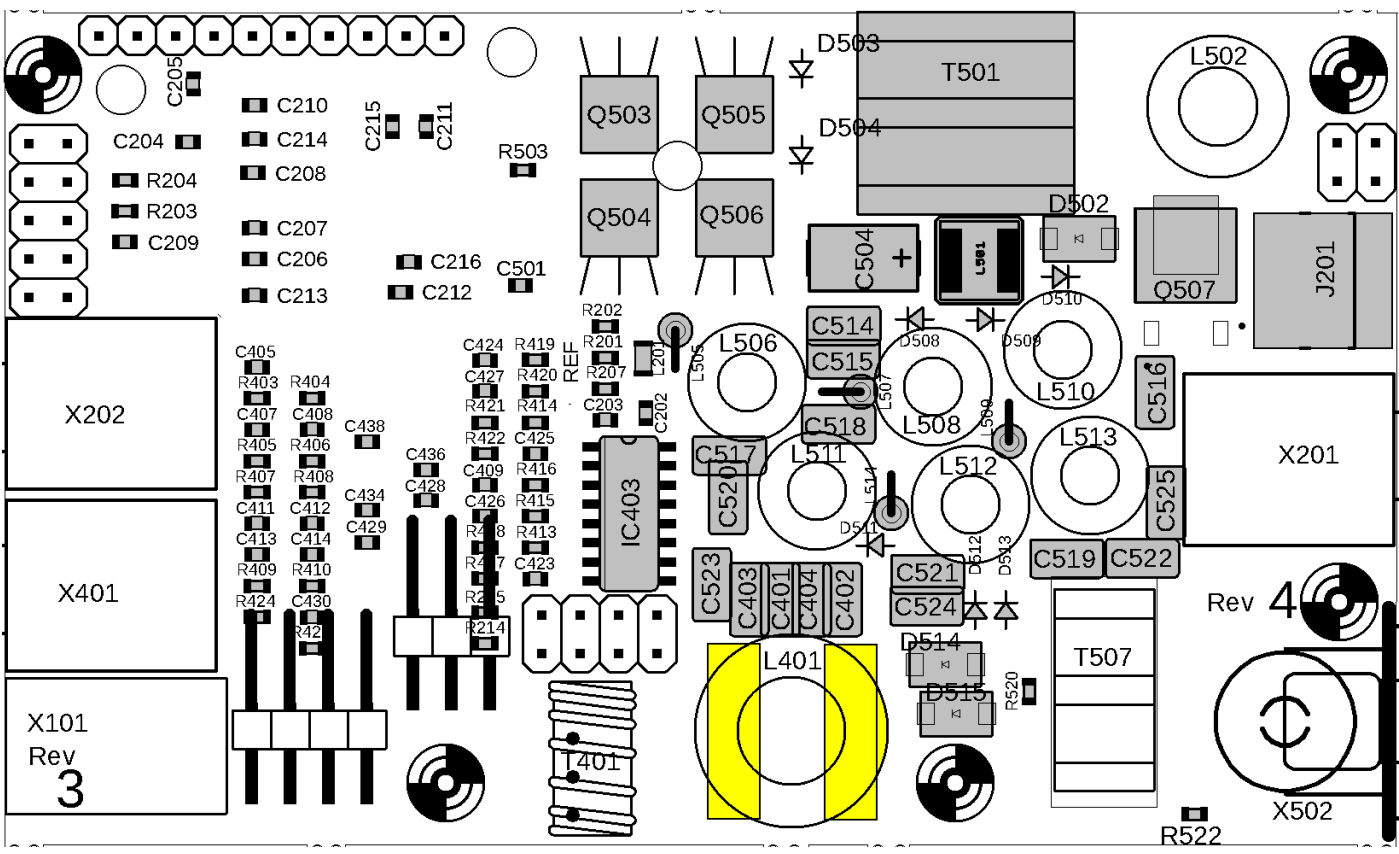

L405a is used by 20, 17 and 15m. It consists of 24 turns tapped at 15 turns. Cut 38cm of wire for winding L405a.

Step 1: Start winding with the wire coming in from the left, over the top of the toroidal core, and down through the hole, out to the right. You continue to fill up the toroid windings anti-clockwise around the core. The start of the winding will henceforth be indicated with 0.

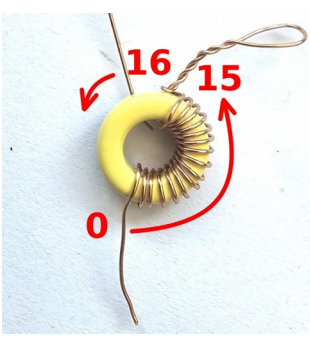

Step 2: Continue winding 15 turns onto the toroid, filling it up in an anti-clockwise direction; after the 15'th turn, create a loop protruding about 2cm or so from the core. Twist tightly as soon as the wire leaves the core.

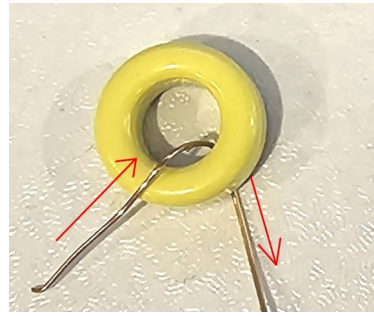

Step 3: Continue winding to complete the whole 24 turns.

Step 4: Now cut all three connections to a length of about 2cm and tin them with solder. The easiest way to do this put a big blob of molten solder on the iron tip, and apply it to the end of each wire (where you just cut it). The solder will easily burn off the enamel at the wire-ends then you can gently move the iron towards the toroidal core, burning off the enamel as you go. As per the picture, even the twisted section at the 19-turn tap gets tinned with solder nicely and evenly and easily.

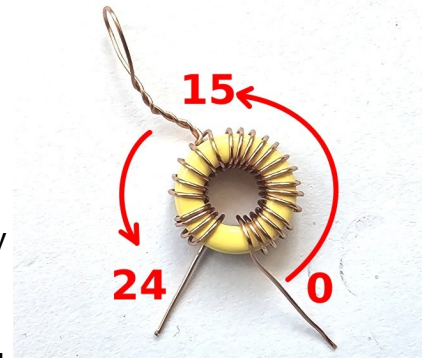
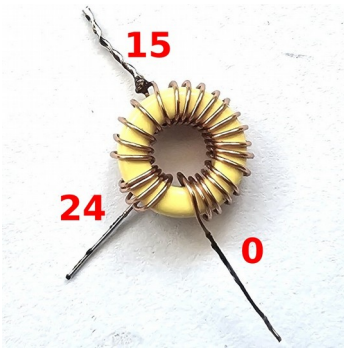

L405b is used by 60, 40 and 30m. It consists of 34 turns tapped at 11 turns. Cut 52cm of wire for winding L405b. Winding L405b should be done in exactly the same way as the above steps for L405a, of course substituting the tap which is now at 11 turns and the total number of turns which is now 34.

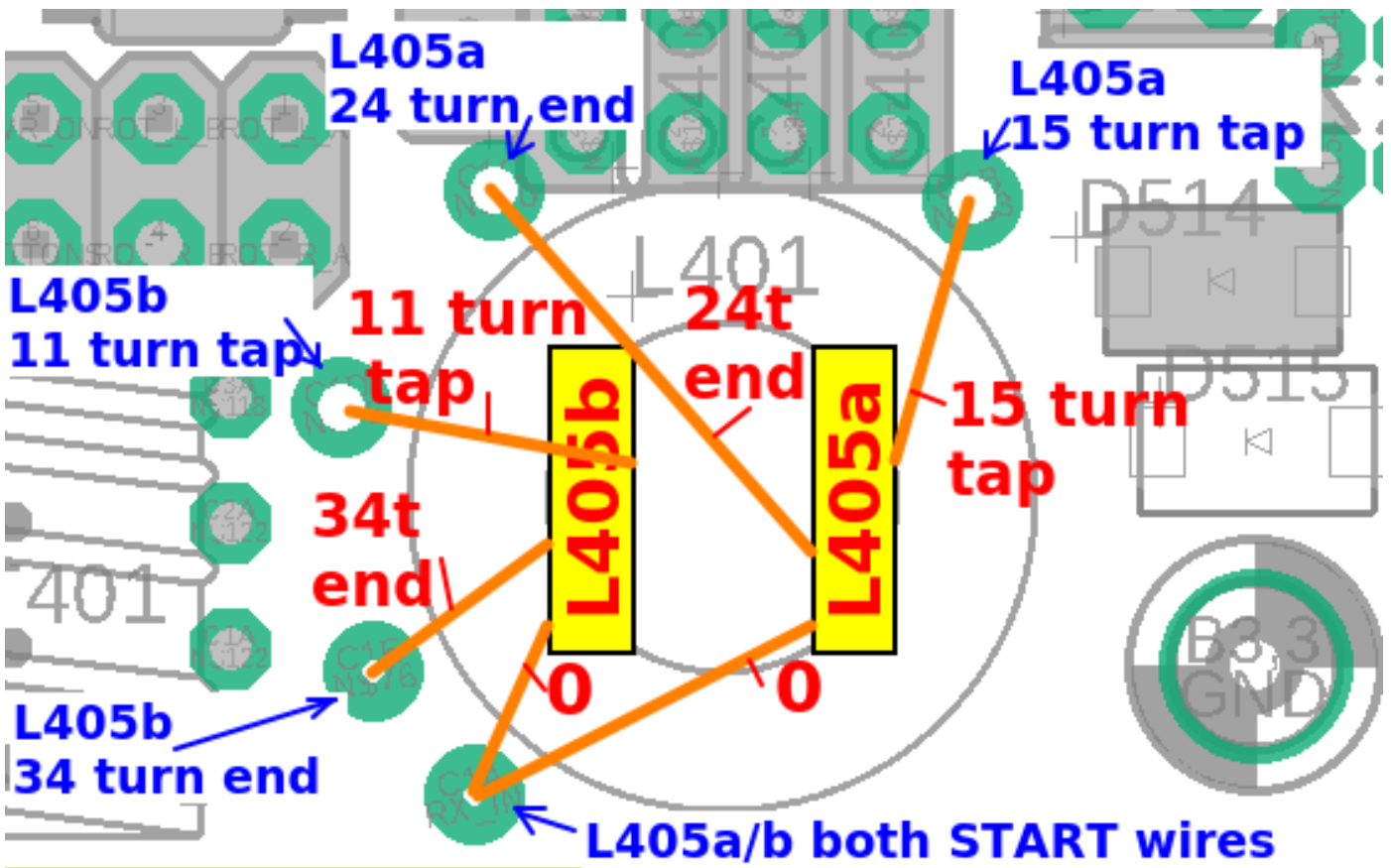

Now install the correct wires in the correct holes. The above diagram is actually more complex than it looks. One of those rare occasions something is easier done than said.

Note that the start hole of L405a/b won't be sufficient diameter to insert both wires. Just insert and solder one (say, L405b start) and solder the other toroid wire (L405a start) to the pad on the top side of the PCB. The top and bottom pads are interconnected by the through-hole plating of the board anyway.

The following page shows two photographs of the completed main board showing the 60-15m band pass filter installation.

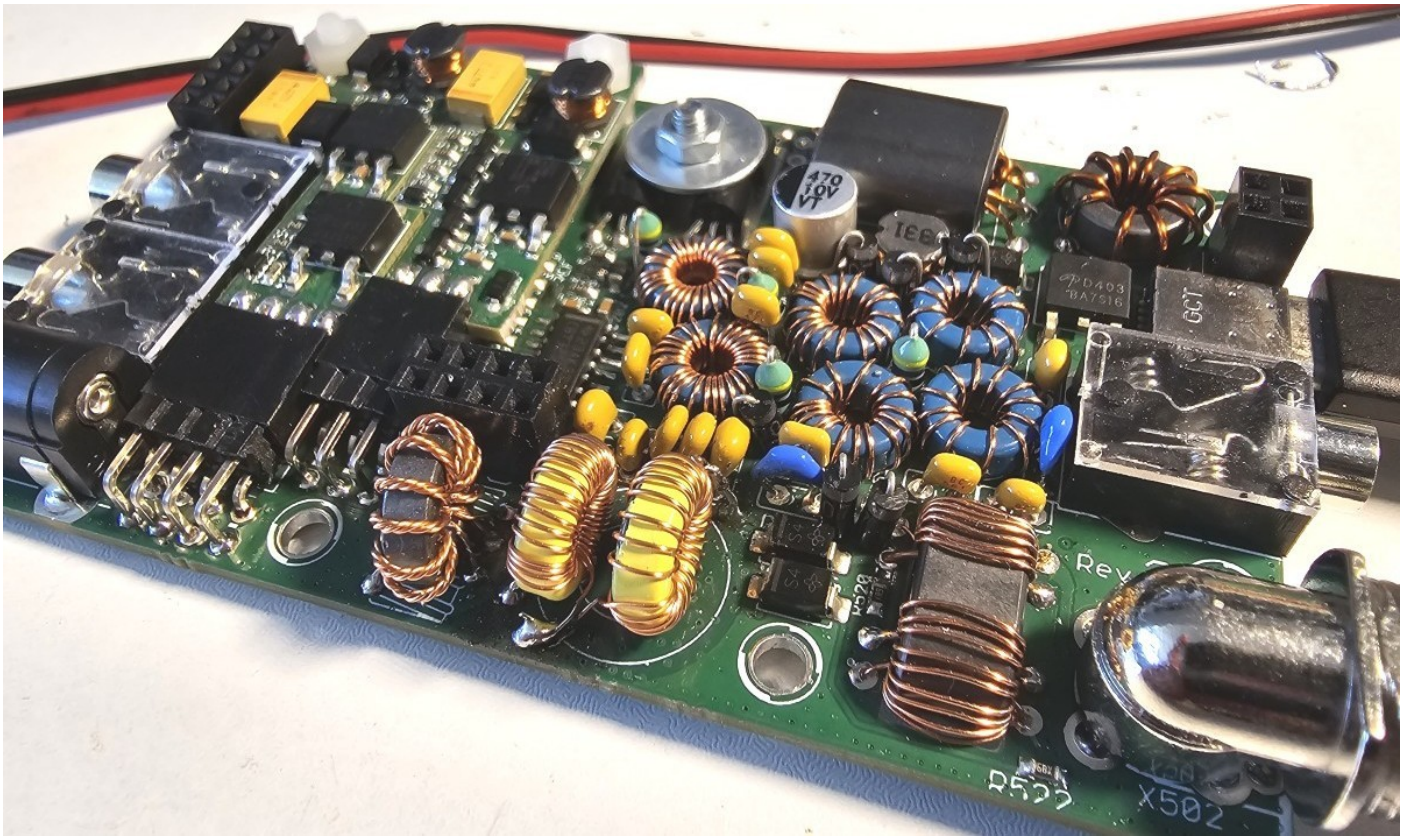

20 / 17 / 15 / 12 / 17m version: L401 is an inductor wound on a T50-6 toroid (yellow colour, large size), having several taps which are switched in according to the operating frequency (band). There are 17 turns in total, with taps at 8, 11 and 14 turns. The diagram shows the location of the taps, which have larger holes, such that two wires can be inserted.

Carefully unwind and cut off approximately 40cm of the 0.33mm (AWG #28) enameled wire, and straighten it, ensuring no kinks.

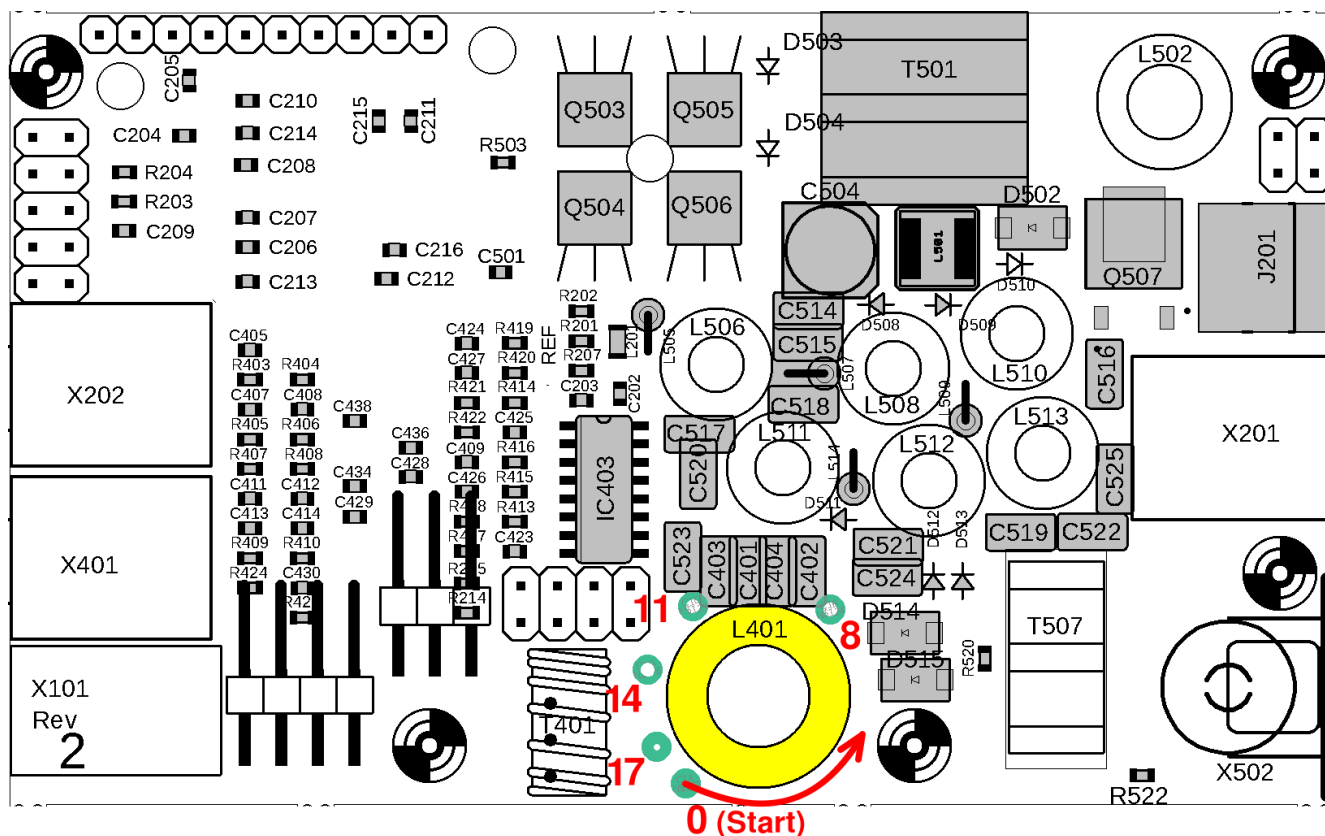

Step 1: Begin winding L401 as shown. Remember that in the nomenclature of toroidal inductors, each time the wire passes through the center of the toroid counts as 1 turn.

Step 2: Wind 8 turns then make a loop between the 8th and 9th turns. This is for the 8 turn tap.

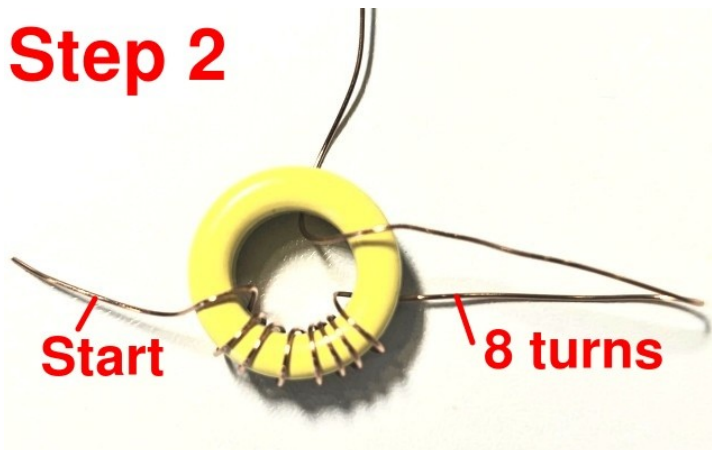
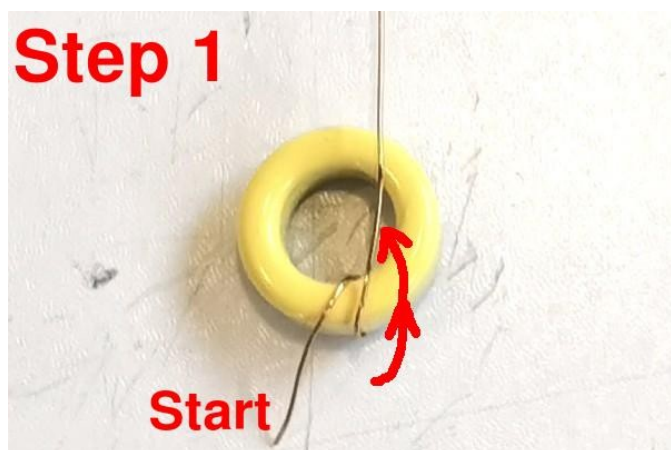

Step 3: Wind up to the 11th turn then make another loop between the 11th and 12th turns. This is for the 11-turn tap.

Step 4: Wind up to the 14th turn then make another loop between the 14th and 15th turns. This is for the 14-turn tap.

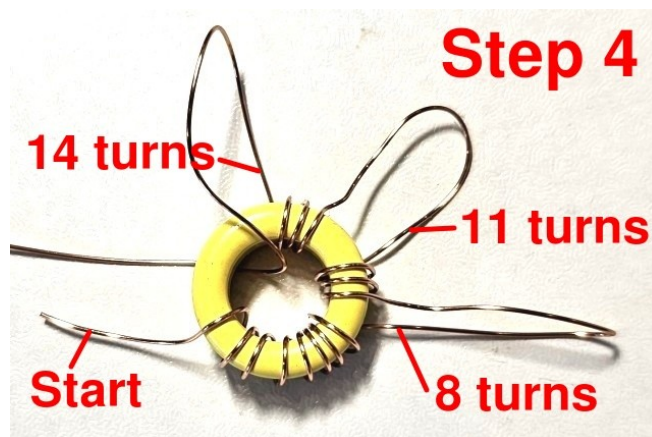
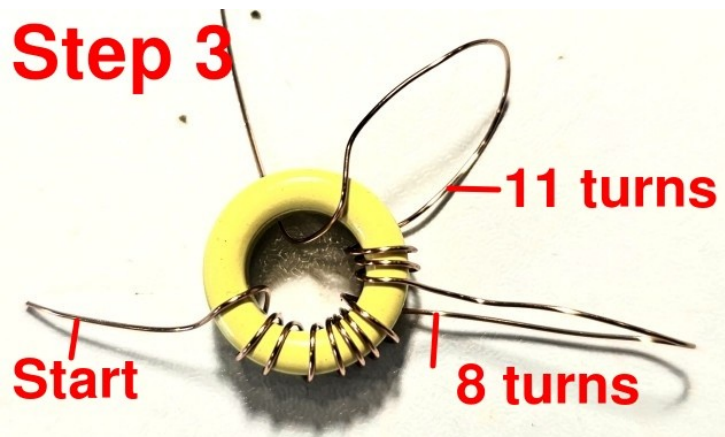

Step 5: Wind the remaining turns to complete the total of 17 turns.

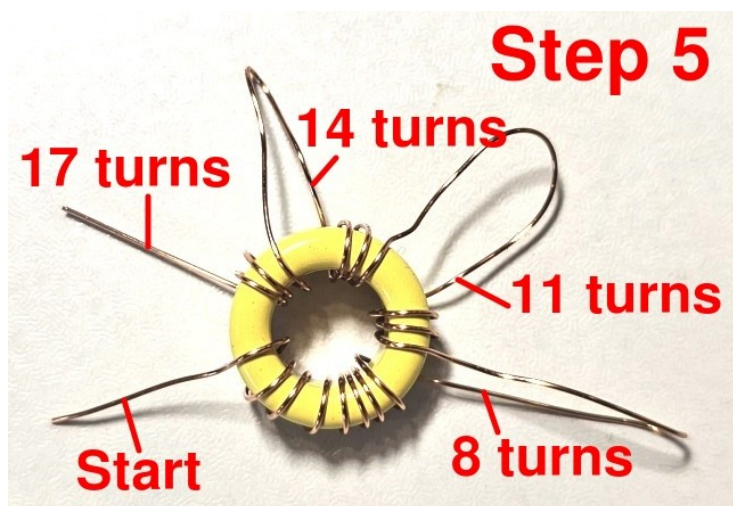

Step 6: Now with a pair of pliers, squeeze each of the loops into a sharp point, such that it is easy to fit through the large holes at the 8, 11 and 14-turn taps (see photo, right)



Step 7: Insert all the wires in their correct holes.

You should pull them firmly from the underside of the board to ensure that there are no loose wires on the top side.

Now cut each wire to about 2mm length (at most) and solder in place. It is essential to remove the enamel from the wire. My favourite method of doing this is simply to hold the soldering iron to the joint, with plenty of solder, for at least 10 seconds. The enamel burns away in this time.

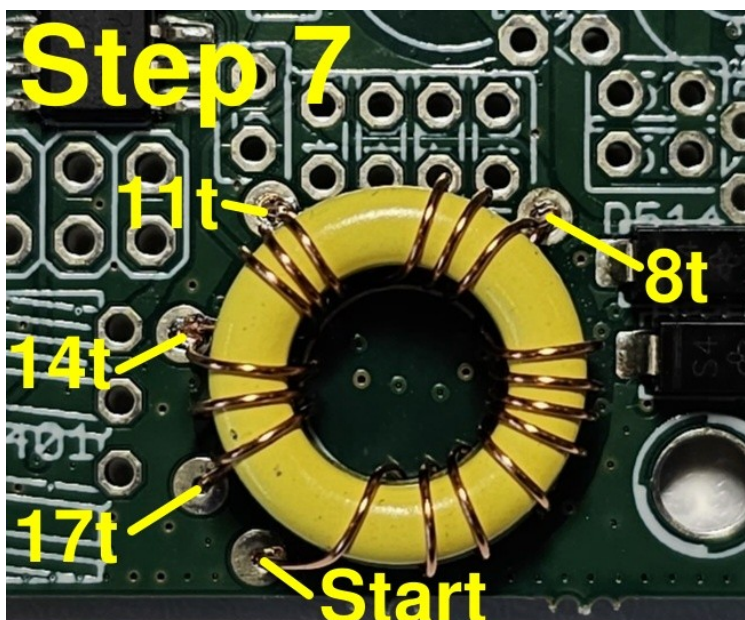

Step 8: Verify the joints are properly soldered, by using a DMM in continuity testing mode (if it has this mode) or check for zero ohms in resistance mode. On the reverse of the PCB, check for continuity between points labeled A, B, C, D, E as shown. You should measure 0 ohms (continuity) between any pairs of these. If you do not, then there is a mistake somewhere, most probably a failure to burn away the enamel at one or more of the L401 connections to make a good joint.

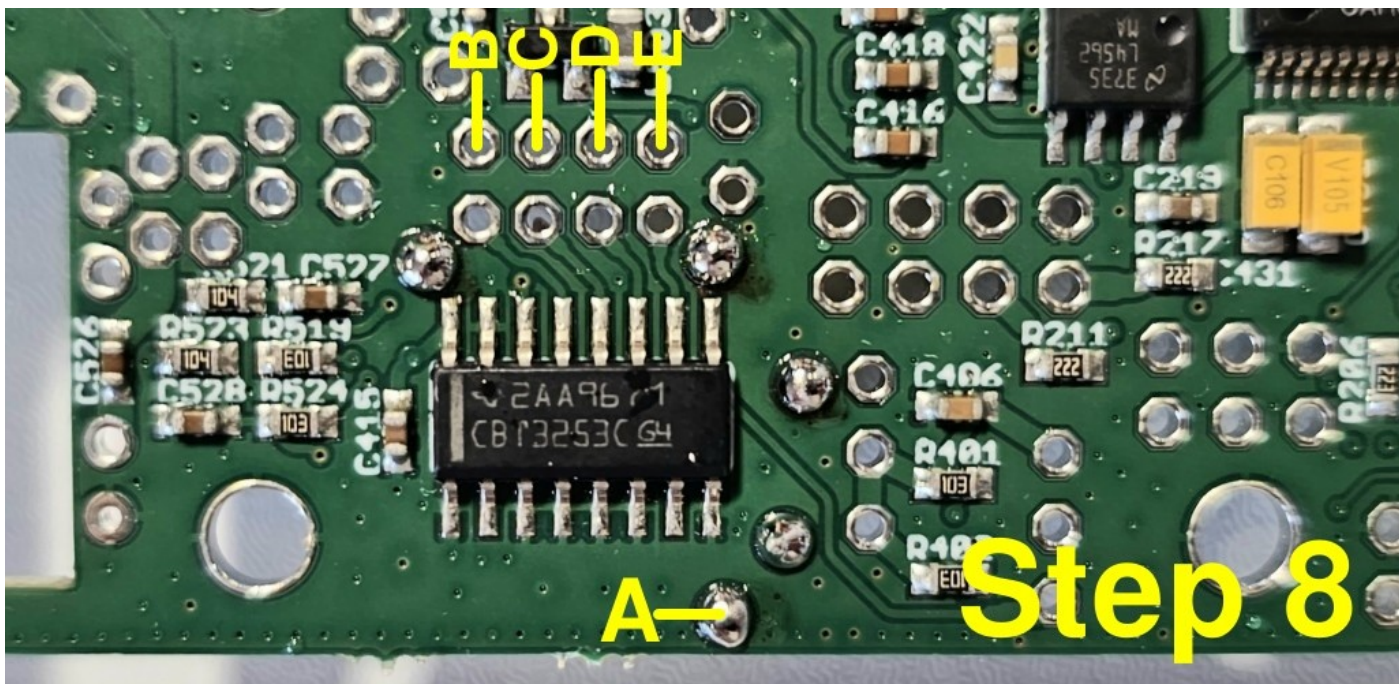

The photograph below shows an example of the wire spacing we have found to work well, providing good band pass filter peaks on the bands 10-20m. Your optimal wire arrangements may vary, tools are provided in the terminal login to optimize this (RF Sweep tool).

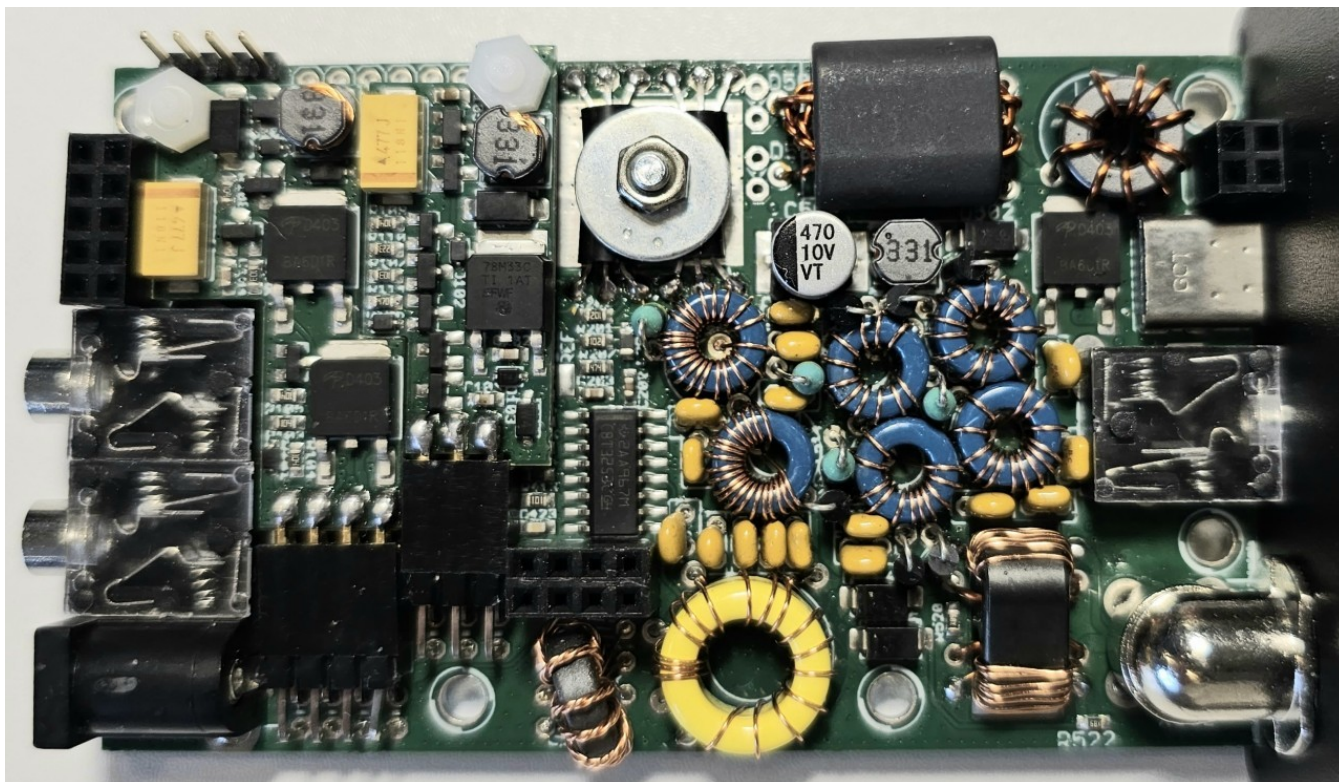

2.11 Wind and install L502

L502 consists of 10 turns of 0.6mm (AWG #22) wire wound on an FT37-43 toroid (**dull black colour**). Firstly, you have to understand that there's a right way and a wrong way to wind a toroidal inductor, too. The terms "right" and "wrong" are probably not as appropriate here, as "handedness" or "winding direction". There are two directions you can wind the toroid. If you choose the right one, then all the wires will automatically end up near the holes they are to be soldered into. If you do it wrongly, it will be a bit messy.



For all the toroidal inductors in the QMX kit, you will get it right, if you start as shown (photo, above right) and pass the wire through the toroid from the top side down through the hole, out and then around and over again; accumulating turns in the anticlockwise direction.

With this in mind, wind 10 turns and install the toroid. As with the output transformer T501, I recommend scratching the enamel with a knife or wire-cutter, and then cutting it to about 2mm length on the underside of the board. Then solder, applying the soldering iron for at least 10 seconds and plenty of solder, to ensure a good connection. Do NOT tin the wires before inserting into the holes: the holes are not large enough to accommodate tinned wires.

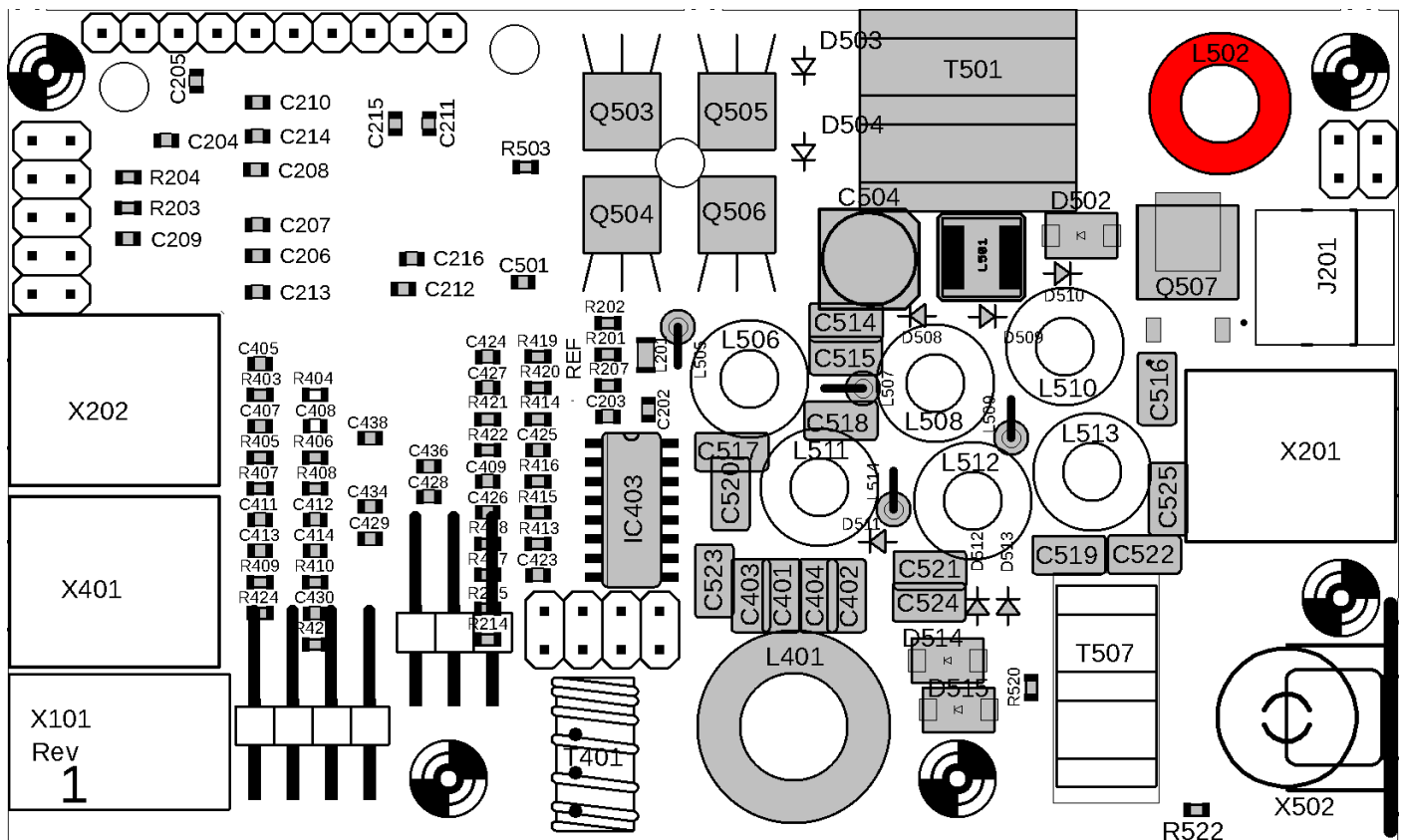

2.12 Install Low Pass Filter toroids

80 / 60 / 40 / 30 / 20m version: Now we'll wind and install the six Low Pass Filter toroids using 0.33mm (AWG #28) enameled wire. Remember, as per the previous direction, using the right winding direction will make the toroids much easier to fit to the PCB. Refer to the table below. Make sure to count carefully and install the toroids in the correct places! Remember that each time the wire passes through the center of the toroid counts as one turn. Spread the turns evenly with a small gap.

Winding the toroids as tightly as possible will slightly improve the performance of the Low Pass Filters. But don't pull so tightly that you break the wire!

The following table lists the required number of turns, cut wire length, and inductance.

Band	Part number	Core	Inductance	Number of turns	Wire length
80m	L511	T30-6 (YELLOW)	2.40uH	26	37cm
80m	L506	T30-6 (YELLOW)	2.88uH	28	40cm
60 / 40m	L512	T30-6 (YELLOW)	1.06uH	17	26cm
60 / 40m	L508	T30-6 (YELLOW)	1.20uH	18	27cm
30m / 20m	L513	T30-6 (YELLOW)	393nH	10	18cm
30m / 20m	L510	T30-6 (YELLOW)	525nH	12	20cm

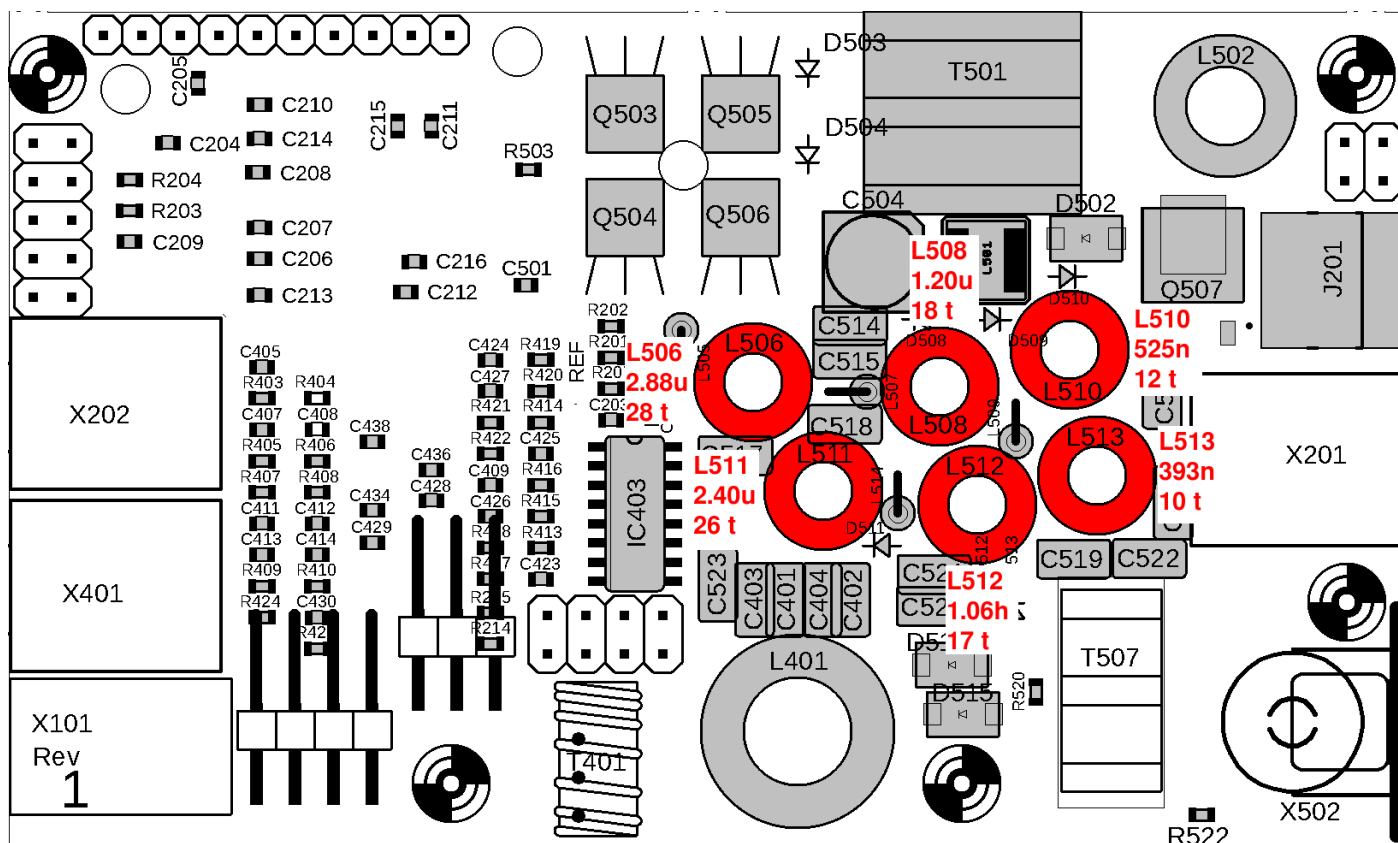

60 / 40 / 30 / 20 / 17 / 15m version: Now we'll wind and install the six Low Pass Filter toroids using 0.33mm (AWG #28) enameled wire. Remember, as per the previous direction, using the right winding direction will make the toroids much easier to fit to the PCB. Refer to the table below. Make sure to count carefully and install the toroids in the correct places! Remember that each time the wire passes through the center of the toroid counts as one turn. Spread the turns evenly with a small gap.



Winding the toroids as tightly as possible will slightly improve the performance of the Low Pass Filters. But don't pull so tightly that you break the wire!

The following table lists the required number of turns, cut wire length, and inductance.

Band	Part number	Core	Inductance	Number of turns	Wire length
60 / 40m	L511	T30-17 (YEL/BLUE)	1.06uH	26	38cm
60 / 40m	L506	T30-17 (YEL/BLUE)	1.20uH	27	39cm
30m / 20m	L512	T30-17 (YEL/BLUE)	393nH	16	25cm
30m / 20m	L508	T30-17 (YEL/BLUE)	525nH	18	28cm
17m/15m	L513	T30-17 (YEL/BLUE)	230nH	12	20cm
17m/15m	L510	T30-17 (YEL/BLUE)	286nH	11*	19cm

*11 turns were found to work better in practice and are recommended, though the "official calculation" would yield 13 turns required.

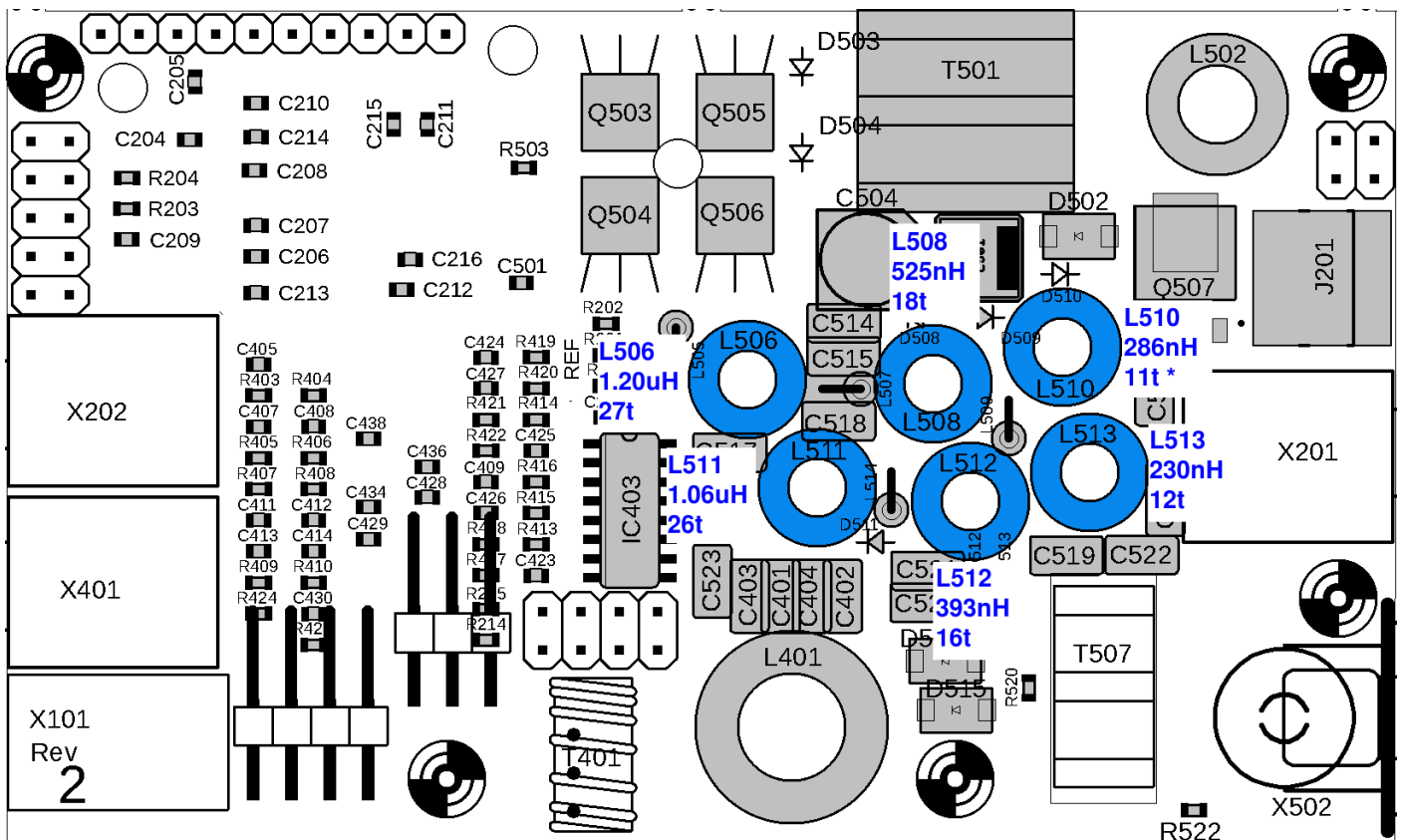

20 / 17 / 15 / 12 / 11 / 10m version: Now we'll wind and install the six Low Pass Filter toroids using 0.33mm (AWG #28) enameled wire. Remember, as per the previous direction, using the right winding direction will make the toroids much easier to fit to the PCB. Refer to the table below. Make sure to count carefully and install the toroids in the correct places! Remember that each time the wire passes through the center of the toroid counts as one turn. Spread the turns evenly with a small gap.



Winding the toroids as tightly as possible will slightly improve the performance of the Low Pass Filters. But don't pull so tightly that you break the wire!

The following table lists the required number of turns, cut wire length, and inductance.

Band	Part number	Core	Inductance	Number of turns	Wire length
20m	L511	T30-17 (YEL/BLUE)	640nH	20	29cm
20m	L506	T30-17 (YEL/BLUE)	706nH	21	30cm
17 / 15m	L512	T30-17 (YEL/BLUE)	230nH	12	20cm
17 / 15m	L508	T30-17 (YEL/BLUE)	286nH	11*	19cm
12 / 11 / 10m	L513	T30-17 (YEL/BLUE)	270nH	13	21cm
12 / 11 / 10m	L510	T30-17 (YEL/BLUE)	314nH	14	22cm

*11 turns were found to work better in practice and are recommended, though the "official calculation" would yield 13 turns required.

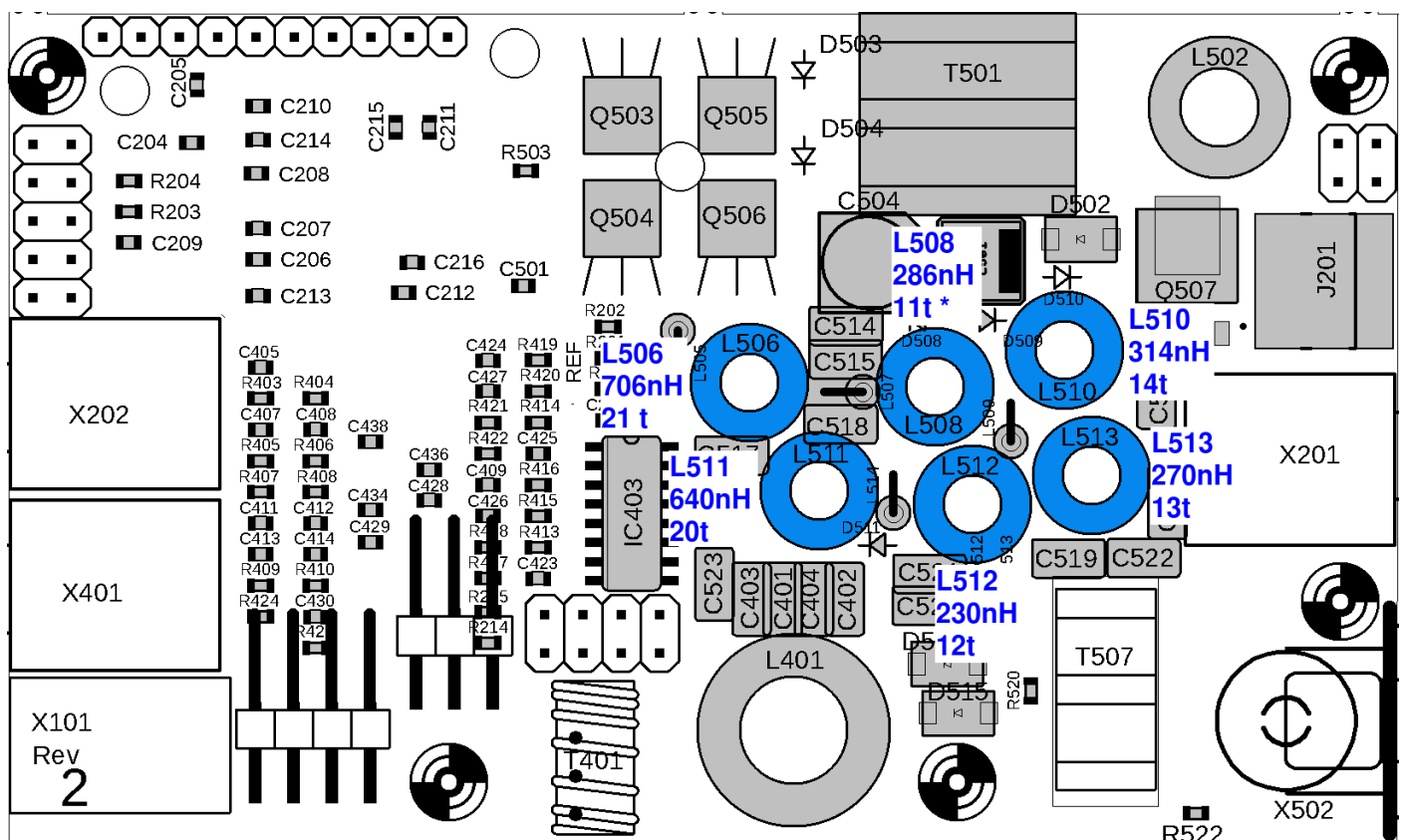

2.13 Wind and install trifilar toroid T401

This toroid needs some care so please follow these instructions very carefully.

Cut three 25cm lengths of 0.33mm (AWG #28) wire. These three pieces now need to be tightly twisted together to make the trifilar wire. My method for this is to tie one end in a knot around a small screwdriver shaft. Similarly tie the other end around another small screwdriver. Now clamp one end somehow to something solid. You could use a vise, if you have one. If you don't, then you have to get creative and think of something. Here I taped it to the edge of the desk. Now you can twist the screwdriver at the free end, repeatedly until you twist the three wires together thoroughly. You need to keep the wire under a little tension to keep the twists evenly spaced.

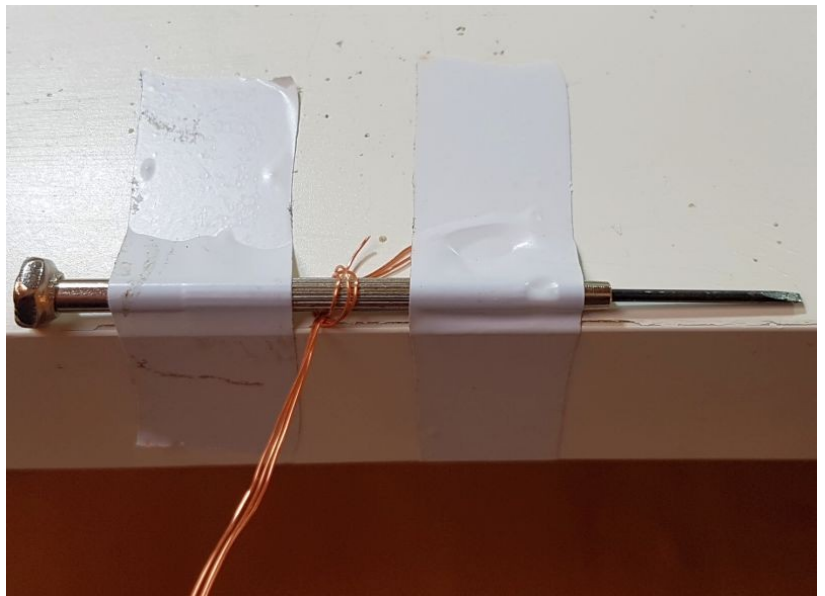
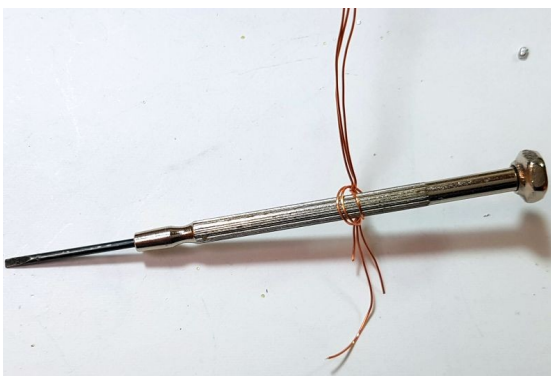
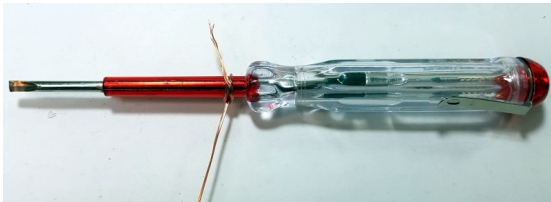

A 20cm length of wire should have about 60 twists. It is not critical.

The end result is something like the photo (right). The measurement scale is in cm.

Now cut off the untidy ends, and this is the piece of wire that will be used to wind the FT37-43 toroidal core as a trifilar transformer.

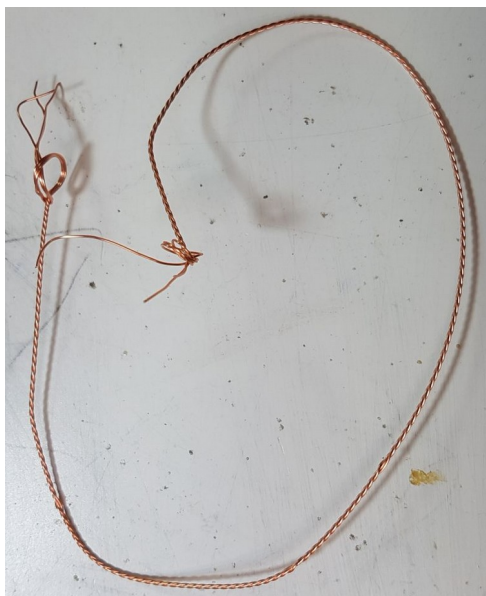

Hold the core between thumb and finger. Pass the wire first from above, to below. Then take the wire from below, and bring it around to pass through the toroid again to form the second turn. After each turn, ensure the wire is fitting snugly around the toroidal core. Wind 10 turns on the core. Each time through the toroid's central hole counts as one turn. Cut off the excess wire, leaving about 2.5cm remaining.

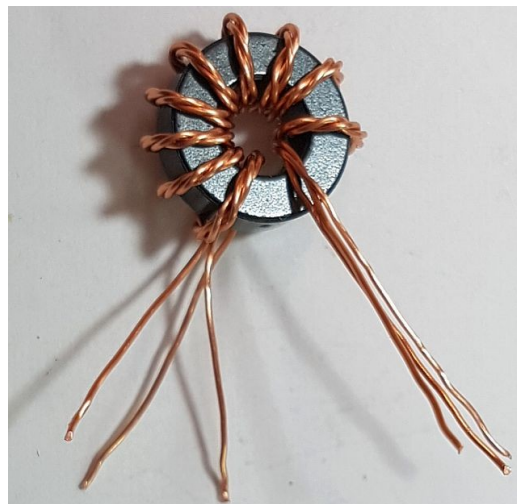
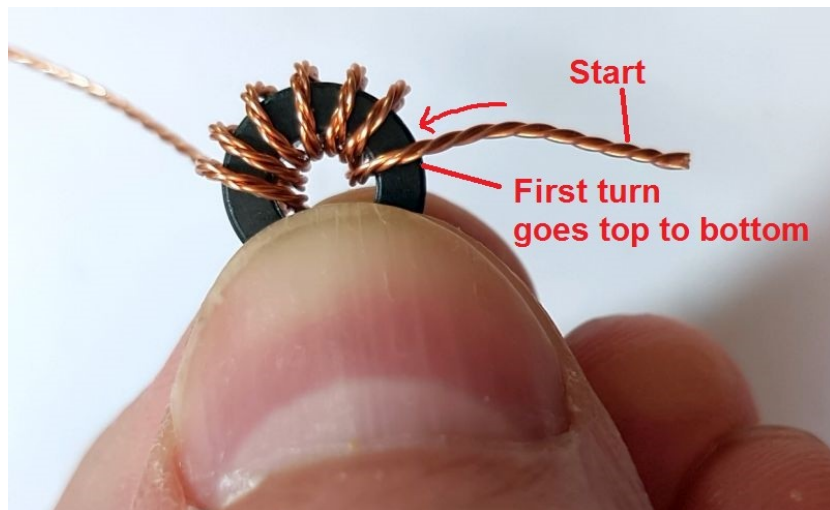

Now it's necessary to identify which wire belongs to which winding. You have three windings twisted together, they all use the same wire. The only way to do this is with a DMM as continuity tester. First, untwist and straighten the wire ends that are not wound around the toroidal core.

Now tin the last few mm at the ends of each wire. You can do this by scraping off the enamel then tinning with the soldering iron; or, if your soldering iron is powerful enough, hold the wire end in a blob of molten solder for a few (maybe 10) seconds, until the enamel burns off.

Now use a DMM to test for continuity. Re-arrange the wires so that there is continuity from A-A, B-B, and C-C in this photo.

Carefully keep this orientation of wires and insert the transformer this way into the PCB. BE CAREFUL not to lose the orientation of the wires! The right wires must be in the right holes, so that the windings are connected correctly in the circuit!

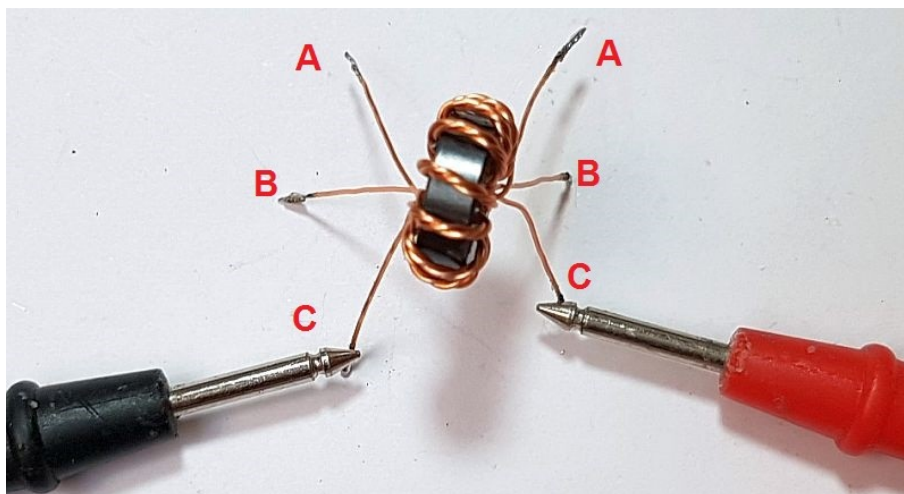

Refer to the diagram on the following page to see the correct orientation.

Once the wires are inserted through the correct holes in the PCB, and pulled tight, check for continuity between the pairs of wires in holes A, B and C once AGAIN. It is much easier to get this right first time, than it is to make repairs later!

When you are satisfied that the wires are all in the correct holes, you can cut them to a length of about 2mm and solder them. It is best to cut-and-solder one wire at a time, since if you cut all the wires to 2mm length then the toroid is more likely to fall out before you've had a chance to solder any of the wires. If that happens, it will be tough to get all the wires back in the correct holes again.

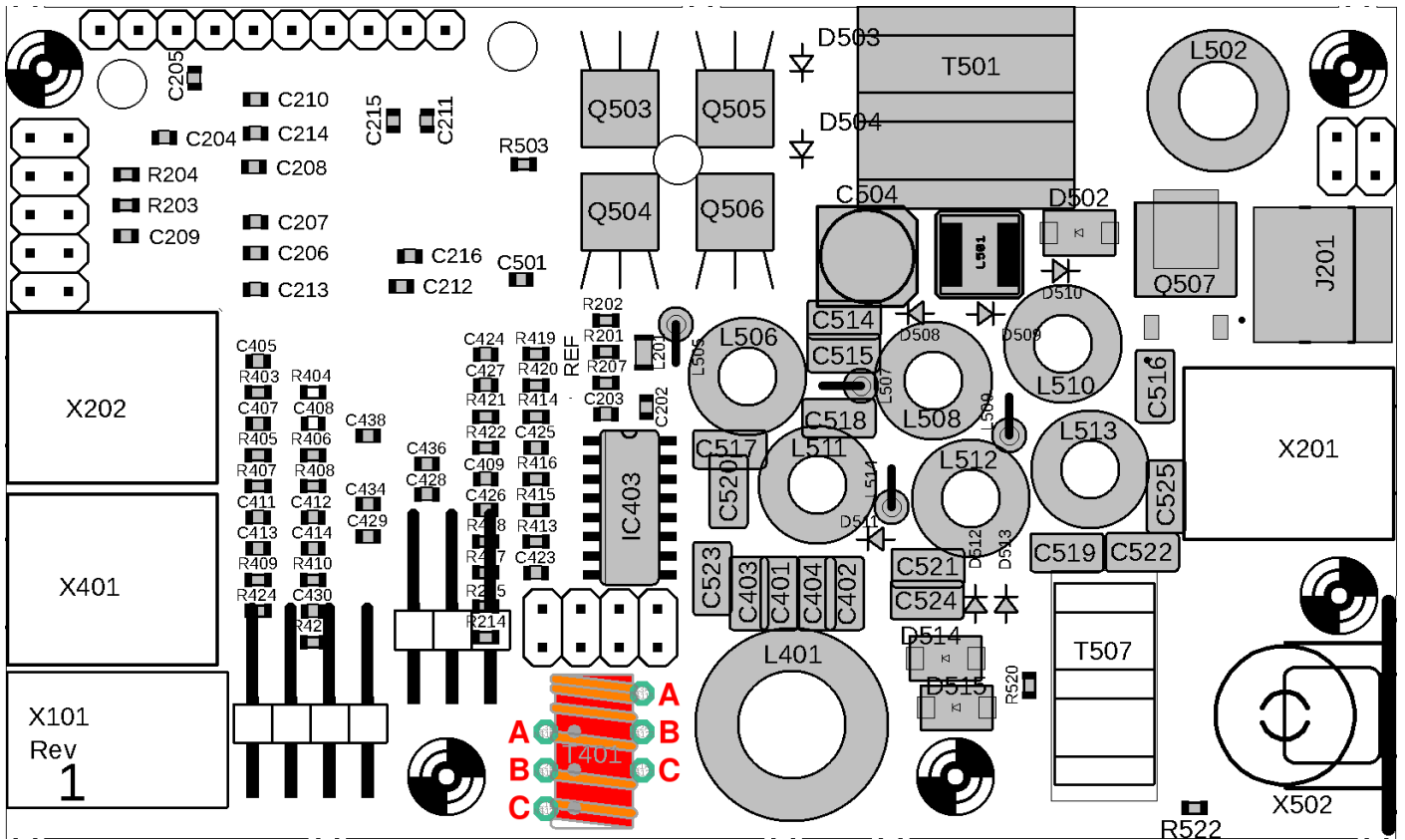

There are numerous SMD components in the vicinity so be VERY careful when soldering the wires of toroid T401, NOT to touch any of the nearby SMD components!

Once again my method involves holding the iron and plenty of solder on the joint for at least 10 seconds to make sure the enamel burns off completely.

The photograph (right) shows the trifilar wire ending holes labeled A B C on the lower side of the PCB. You should check for continuity between all these. A, B, C and pin 9 of IC402 are all connected together. They are also connected to pins 7 and 9 of IC403 which is the 74CBT3253 on the top side of the board.

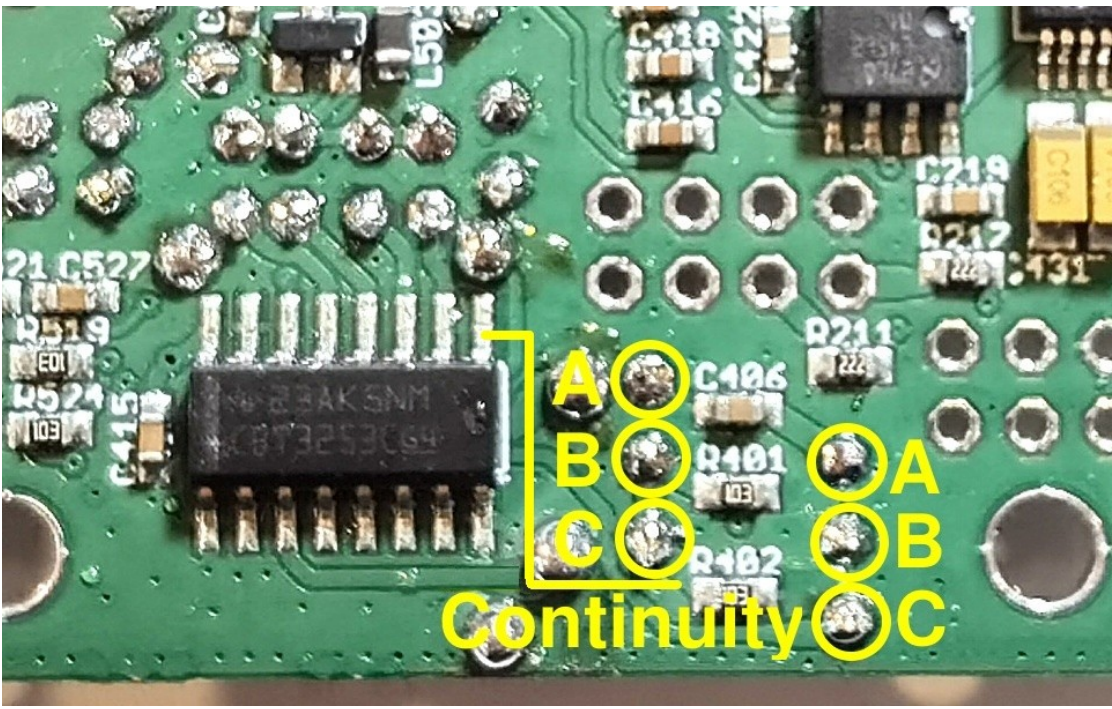

2.14 Wind and install transformer T507

Cut two lengths of 0.33mm wire, each approximately 25cm long. Wind 10 turns through each hole of the BN43-1502 binocular core. Cut two 25mm lengths of 0.60mm wire. These are threaded only ONCE through each hole.

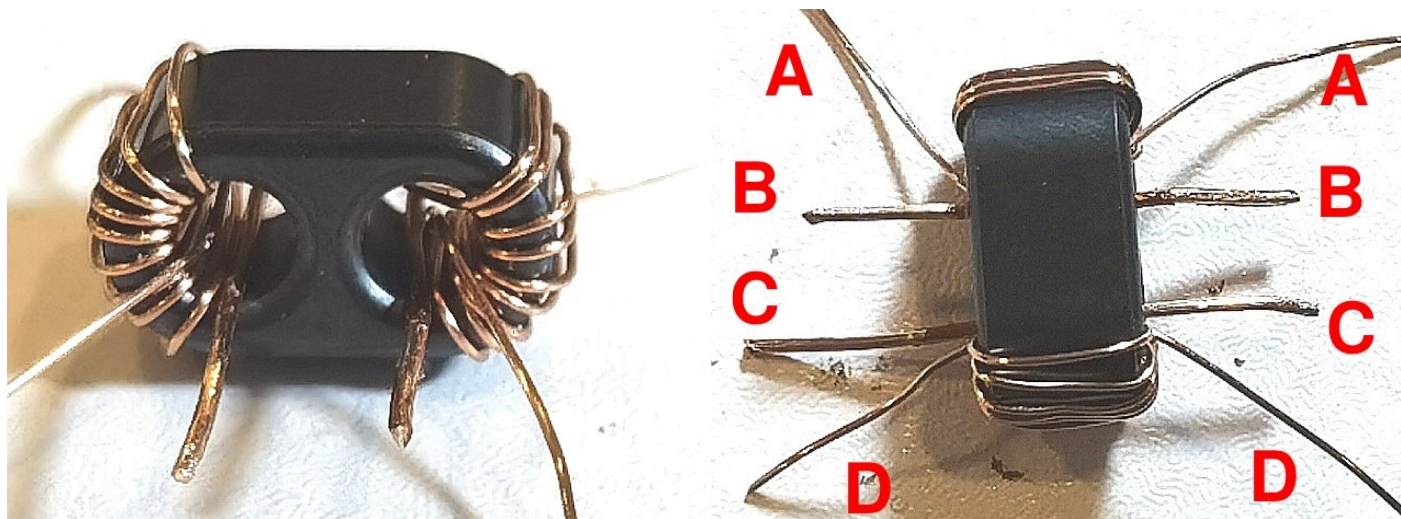

The transformer is installed as shown on the diagram. The 0.60mm wire single-turns (ONE time through the hole) are installed at B-B and C-C. The enamel needs to be scraped off the ends before installation but not tinned (it would not fit in the holes). The thinner 0.33mm ends of the 10-turn windings are fitted at A-A and D-D.

The transformer is designed to sit in the cut-out of the PCB. This is so that when the controls board is installed above it, the height of the transformer binocular does not clash with the bottom of the right-hand rotary encoder body. It should protrude about 1mm below the bottom surface of the PCB. You can adjust the 10-turn windings, pushing them around the core such that they are on the top side of the PCB, to achieve this. BEFORE soldering.

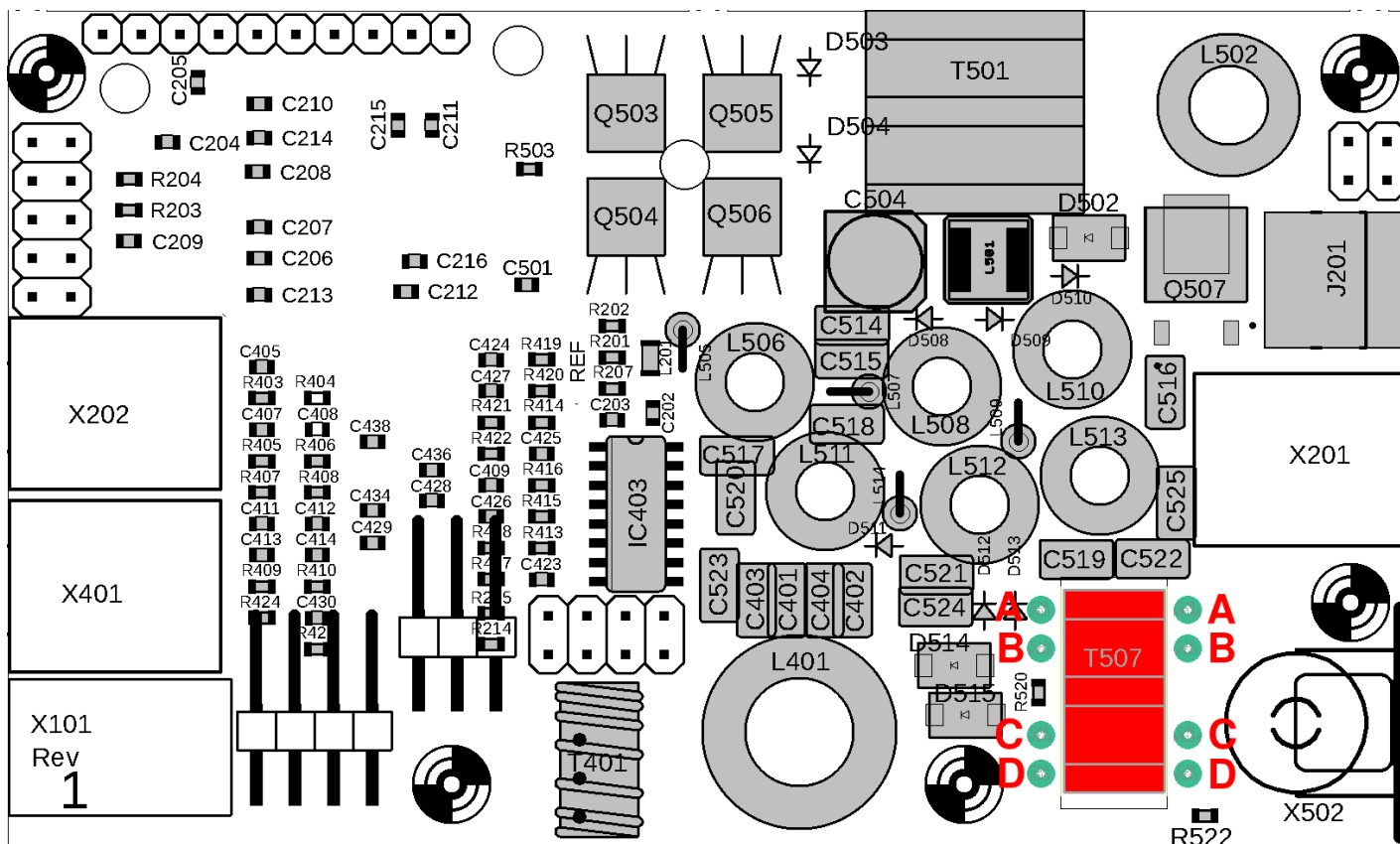

2.15 Install connectors

Install the five connectors as follows (USB-C is already SMD assembled):

- X101: DC Power connector
- X202: 3.5mm jack, Paddle connector
- X401: 3.5mm jack: Audio headphone output
- X201: 3.5mm jack: PTT output
- X502: BNC RF connector – NOTE: there is a footprint for an SMA connector that you may install if you wish; however this will have gaps around it as it pokes through the enclosure.

It is very important to install these carefully aligned so that they are straight and at right-angles with respect to the PCB. The connector body should not protrude beyond the edge of the PCB. 3.5mm stereo jack connectors X202, X401 and X201 will try to NOT sit at 90-degrees, they will try to sit slightly twisted; it is important to apply necessary force to hold them in the correct 90-degree orientation with respect to the board edge, during soldering.

When the connectors are well-aligned, you will have no trouble fitting the PCB into the optional enclosure. A good potential strategy is to bolt the right panel to the BNC connector during installation to make sure that everything sits square (90-degrees).

Clip off excess leads and tabs to make sure nothing protrudes more than 1.5mm.

It's a good idea to inspect the USB-C connector soldering (labeled J201). This is a high quality part with through-hole pins which are designed to be soldered by SMD machines. It could be worth touching up the connections to make sure all the joints are electrically and mechanically sound, including the mounting tabs. Be very careful to avoid any solder bridges short-circuiting the pins of the connector, which are very close-spaced.

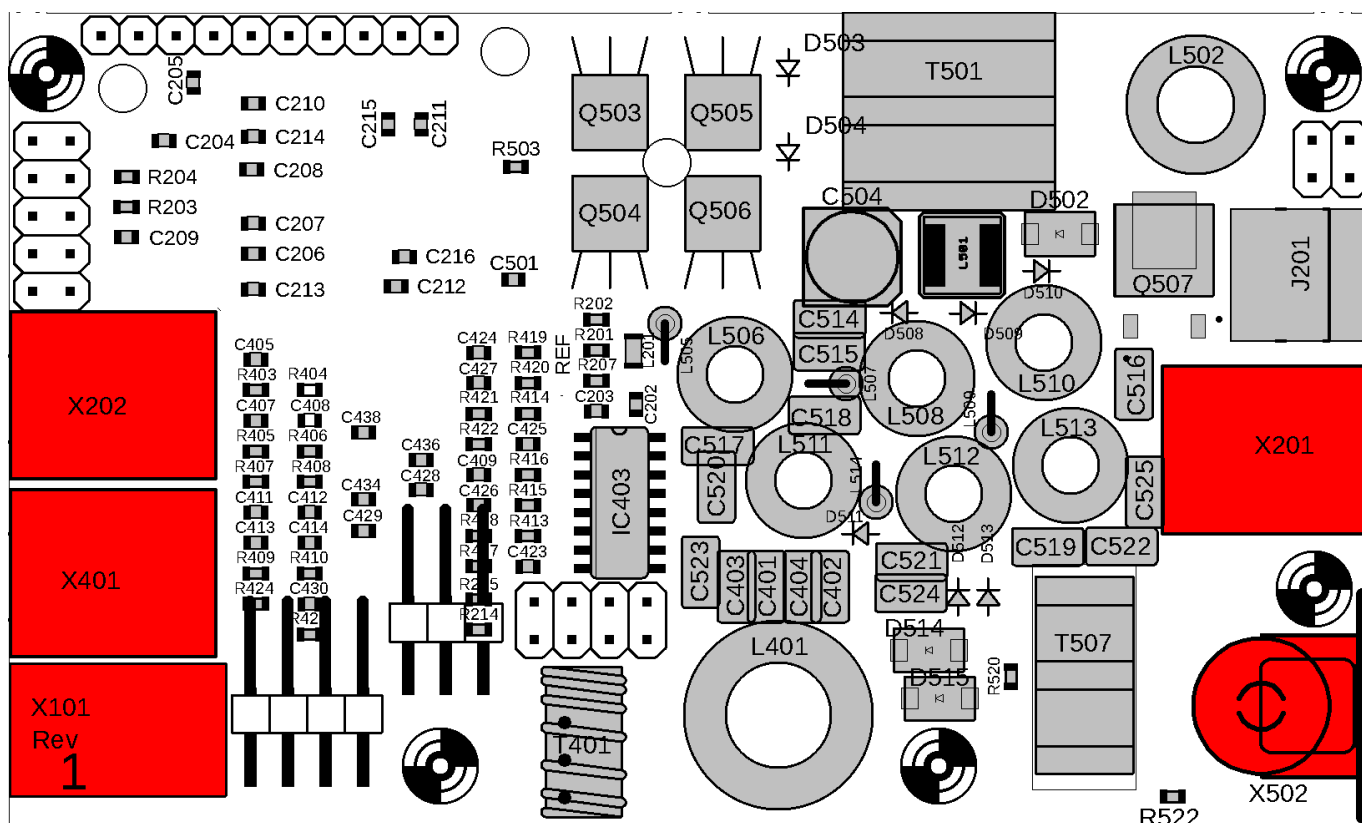

2.16 Install pin header connector sockets (female)

Install the following female pin header connectors:

- 2x5-pin header connector socket (female)
- 2x4-pin header connector socket (female)
- 2x2-pin header connector socket (female)

Be careful to ensure that the pin headers are accurately aligned, they should sit square in the PCB not at a slightly twisted angle.

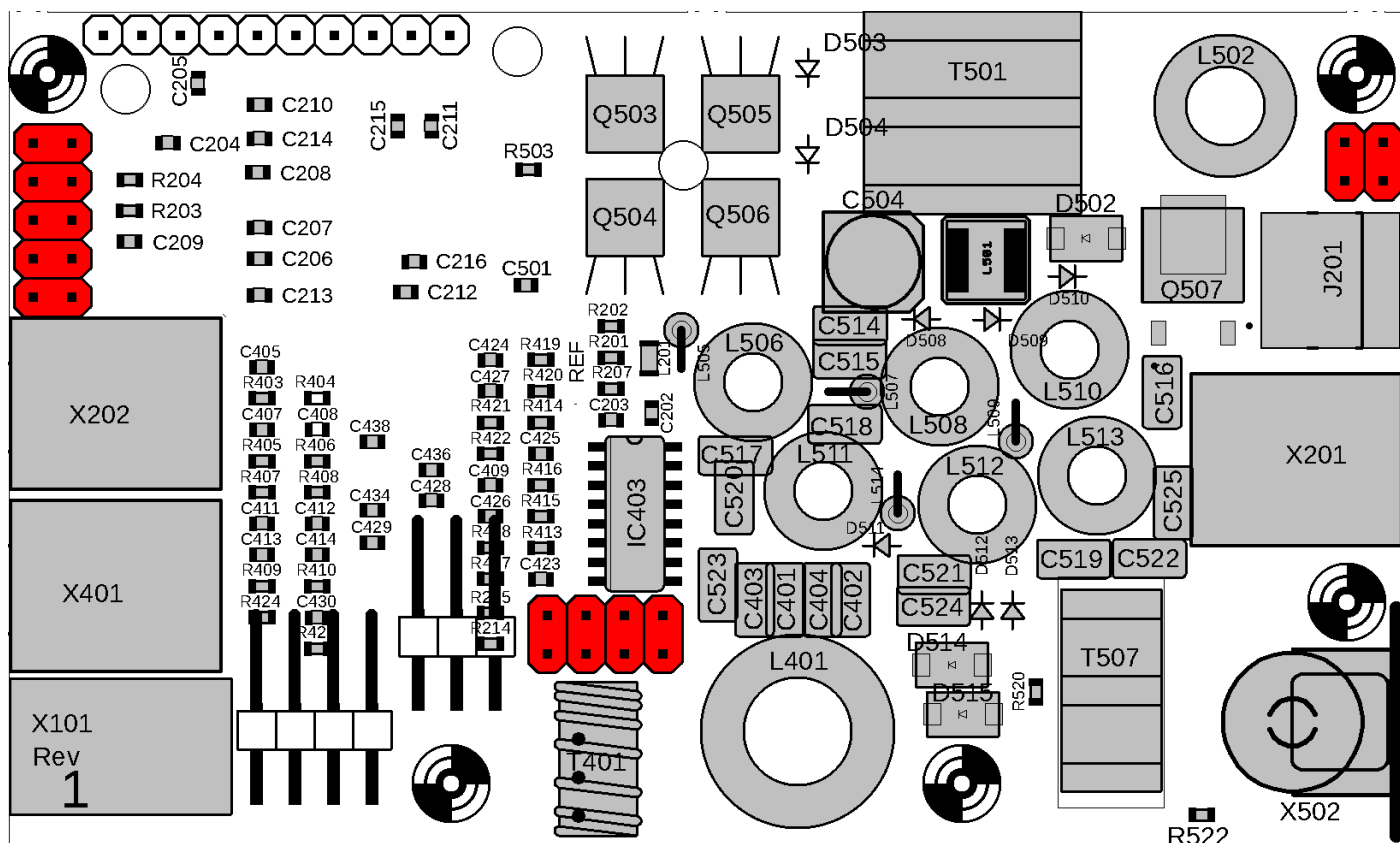

2.17 Install power supply boards

To complete the assembly of the main board, install the power supply boards. This is a little tricky and needs to be done with care to ensure that the board connectors all sit square and at the right height etc. The following steps are strongly recommended.

1. Prepare power supply boards: the two power supply boards should have been removed from the main PCB panel earlier. Ensure the board edges are filed smooth, with no remains of the throwaway board tabs that held them inside the panel. Do NOT at this stage, solder on the 2x4 and 2x3-pin female pin header connector sockets.

2. Fit nylon bolts: The two power supply boards have a hole at the end opposite to their connectors, which allows them to be bolted securely to the main board. Each fastening requires:

- 9mm nylon screw, with its head end on the underside of the main PCB.
- M3 nylon nut, fitted on the top side of the main PCB as a spacer.
- M3 nylon nut, which will be used to secure the power supply board after it has been fitted on the screw.

For now, thread the two nylon bolts from the underside of the PCB through the holes marked in RED near the top edge of the PCB in the diagram shown below, and screw on the two nylon “spacer” nuts, on the top side of the PCB.

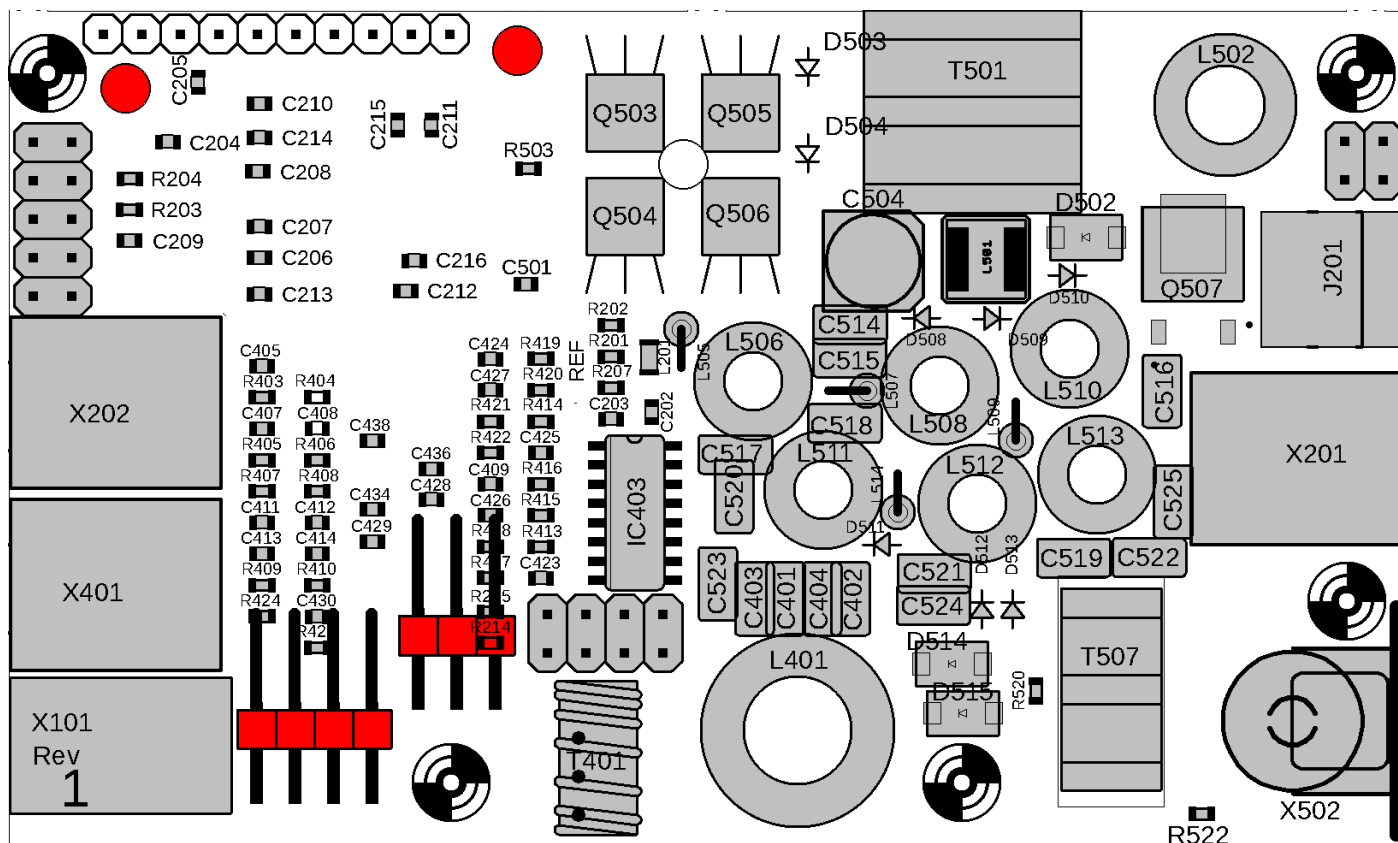

Note that the following photographs show incorrect metal screws, not the specified 9mm nylon M3 screws; this is because I had no stock of the nylon screws at the time of the photograph.

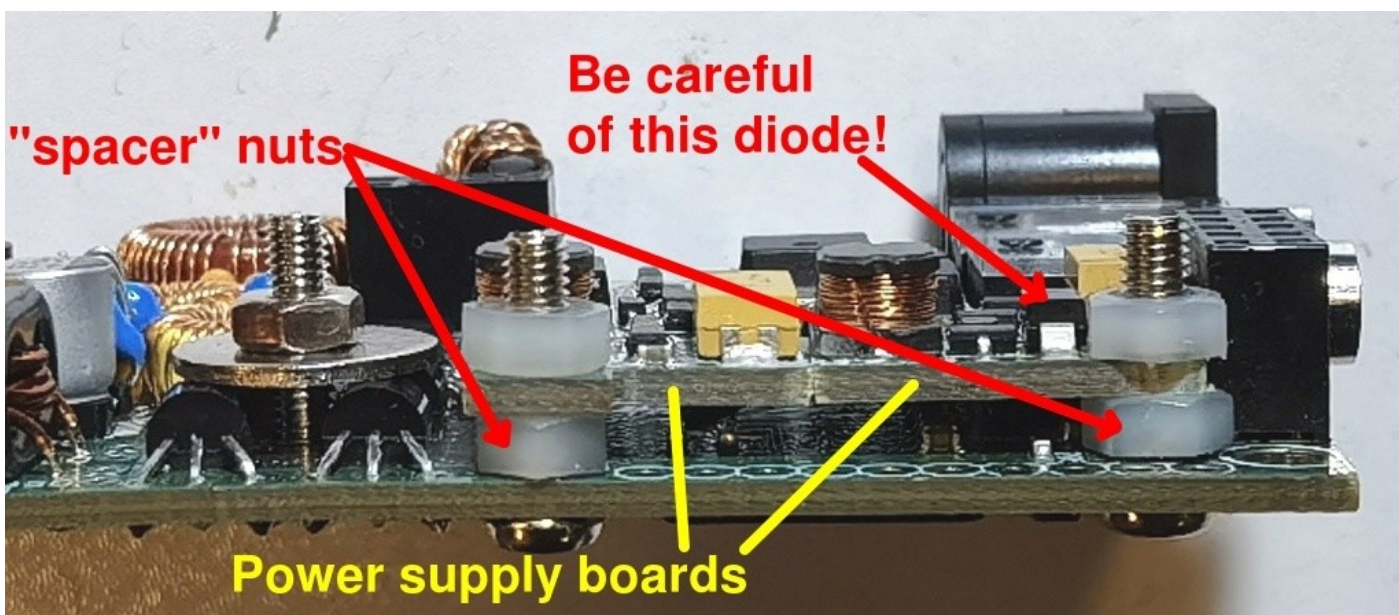
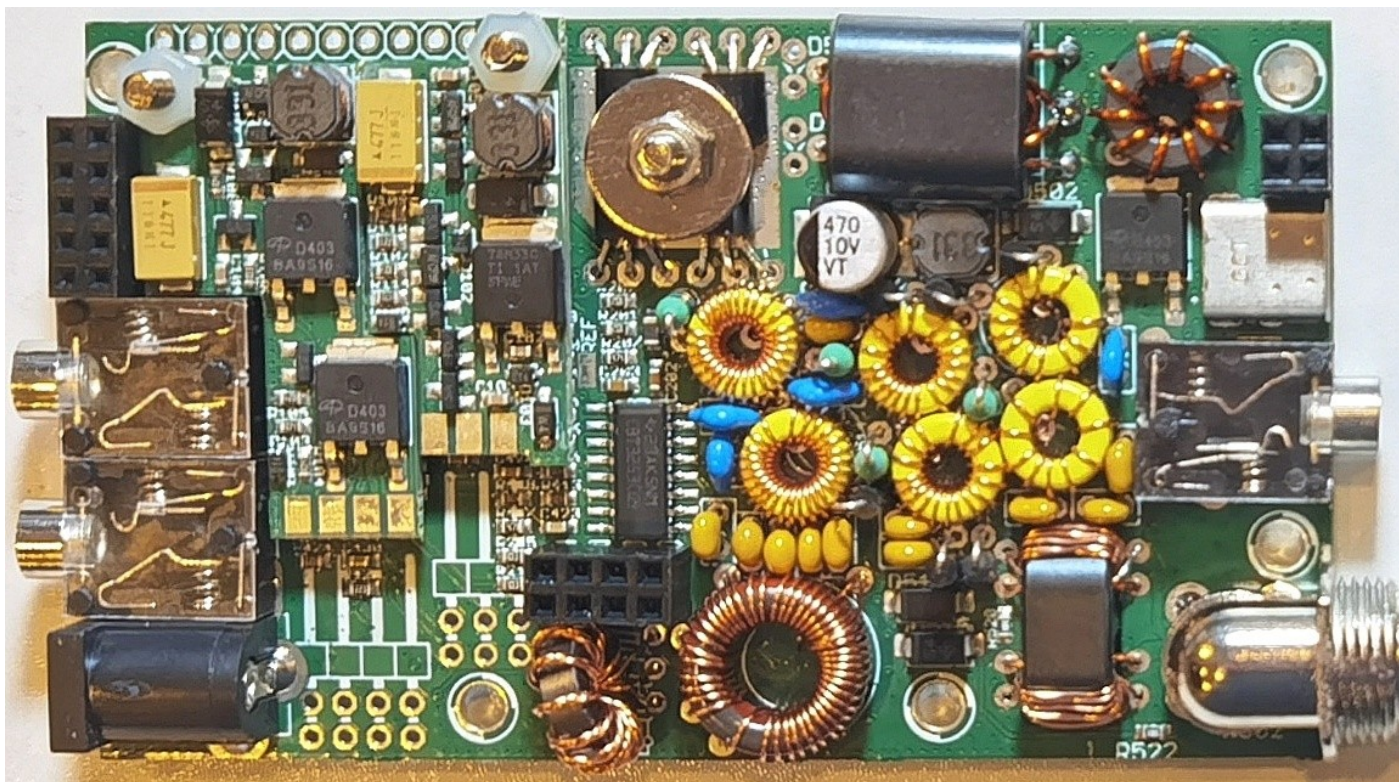

3. Fit power supply boards: Fit the power supply boards over the protruding 9mm M3 nylon screws, and thread on another nylon nut on the top side of each board. Tighten it carefully by turning the screws from below the board. Take care not to damage the nearby 2x5-pin connector or BS170 transistors, or any of the delicate SMD components on the power supply boards. The diode shown is particularly vulnerable.

4. 2x4-pin and 3-pin header connections: Find the 2x4-pin male 90-degree pin header and 2x3-pin. Find the matching female connector sockets (2x4-pin and 2x3-pin). Mate them with their male pin header plugs.

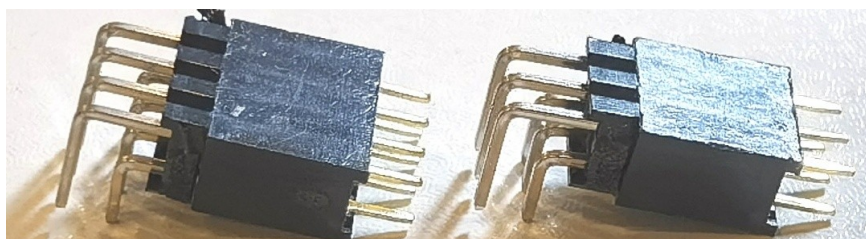

5. Fit connectors to boards (do not solder): The PCB pin sides of the female pin header sockets are threaded edge-wise on the power supply board edges. Meanwhile the PCB pins of the 90-degree headers are to be inserted in the main board.

It is important to note that the 90-degree male pin header plastic body parts are NOT supposed to sit flush on the main PCB. Neither is it necessary for the plastic parts of the female connector parts to fit snugly next to the edges of the power supply boards. Gaps in these locations are fine and are necessary for everything to line up square. **It is, however, a good idea to cut off approx 1mm from each female header pin connector, to reduce the possibility of shorts and solder bridges.**

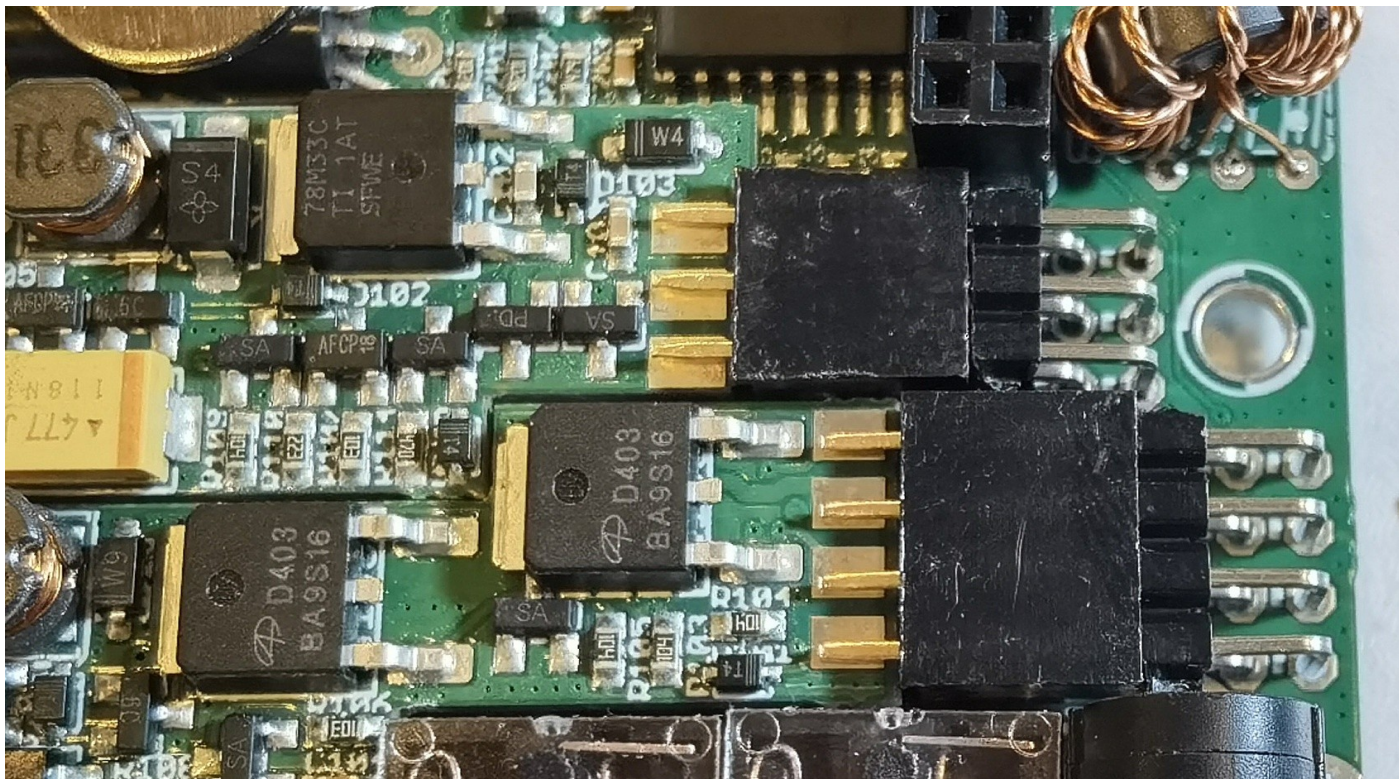

6. Solder 90-degree male headers to main board: Make sure that all the boards are nicely and neatly aligned; the gap under the boards should be constant (determined by the thickness of the two nylon “spacer” nuts. Everything should look square. Only then are you ready to solder the 90-degree male headers (2x4-pin and 2x3-pin) to the main board. Again: do not try to force them to sit flush on the surface of the main QMX PCB. Have them suspended off the surface 1mm or whatever, such that the power supply boards sit level. **If you have an adjustable iron: lower the temperature. Solder quickly so as not to melt the plastic of the connectors.**

Be careful not to damage nearby SMD components or create any shorts or solder bridges! Inspect with the jeweller’s loupe!

7. Solder top side of power supply board “edge connector” headers: The two female pin header connector sockets fitted edge-on at the power supply board edges can now be soldered on the top sides. The bottom sides are not accessible at this point. Note that there can be gaps because the gap



between the rows of pins is larger than the 1.6mm thickness of the PCB; this is fine too, no problem. Try to solder quickly so as not to melt the plastic connector body.

8. Remove power supply boards and solder

bottom pins: Now carefully remove the two nylon screws that secure the power supply boards, and unplug the power supply boards gently. The safest way to do this is to pull on the large AOD403 transistors with one fingernail. Do NOT pull on the 330-uH inductors! Now you can solder the bottom rows of pins on the undersides of the power supply boards. Again – gaps are fine. Try to solder quickly so as not to melt the plastic connector body.

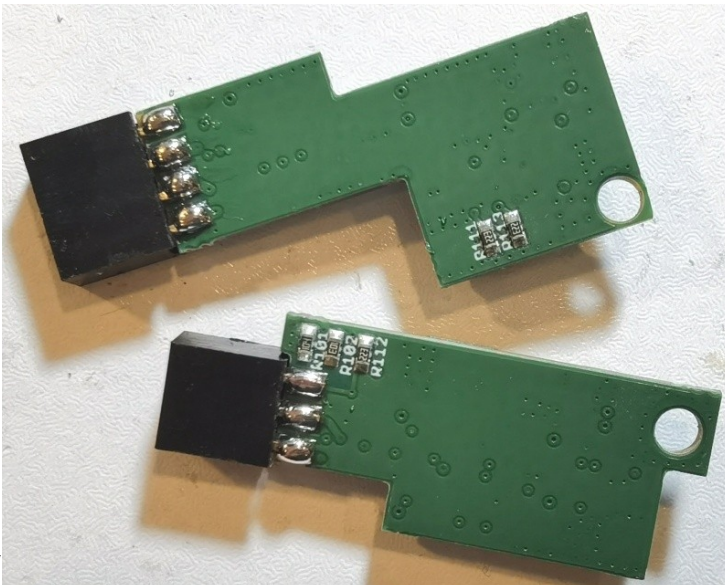

9. CHECK! It is very important to check all the connector joints, both the edge-connected female header connectors on the power supply boards, AND the male 90-degree headers on the main board. Check using a jeweller's loupe for any dry joints, poor connections, short-circuits, solder bridges.

These boards are by far the least forgiving part of the project! Any short here, has the potential to FRY the entire board.

10. Re-install power supply boards: Now plug in the power supply boards again, thread them over the nylon screws, and re-install the nylon nuts, tighten securely. Be careful while tightening the nuts, not to damage any nearby components such as the SMD components on the power supply boards. Do not over-tighten in your enthusiasm (it's only nylon). **The bolt near the PCB corner should be pushed firmly away from the corner, or it will interfere with the 11mm nylon spacer later.**

The main QMX board assembly is now complete!

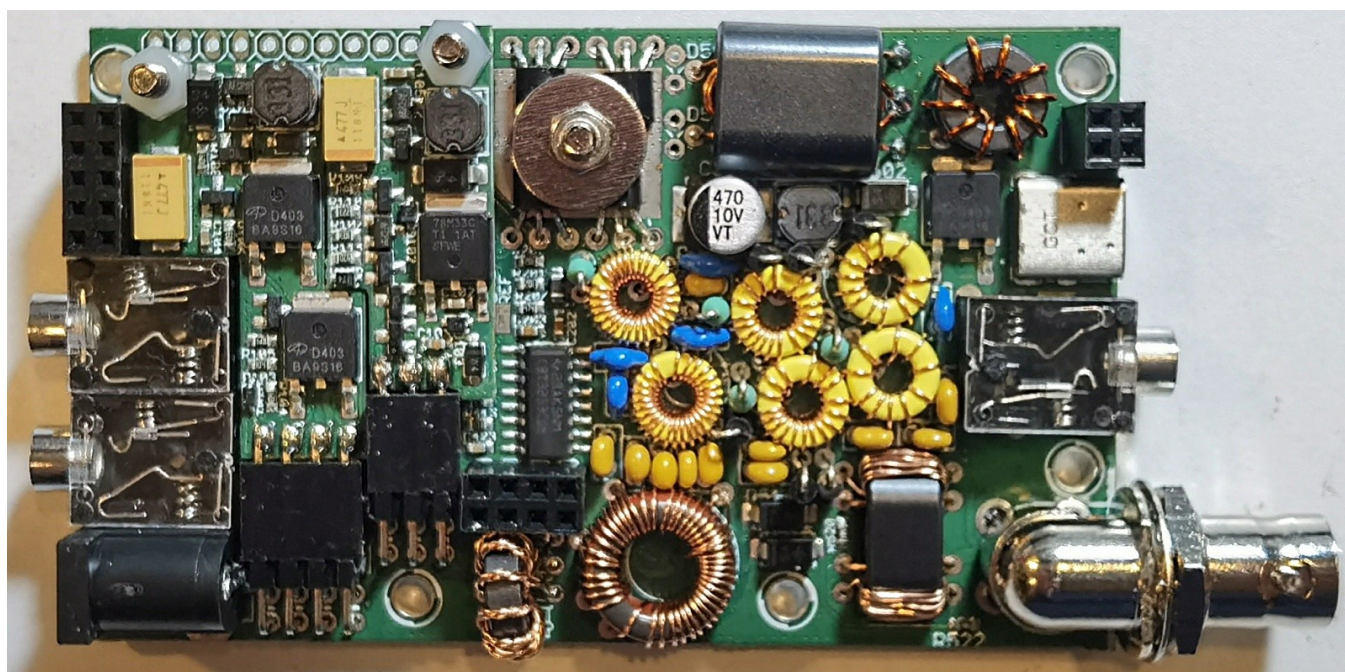

2.18 Install LCD module

Precision assembly is essential – follow the guide below carefully.

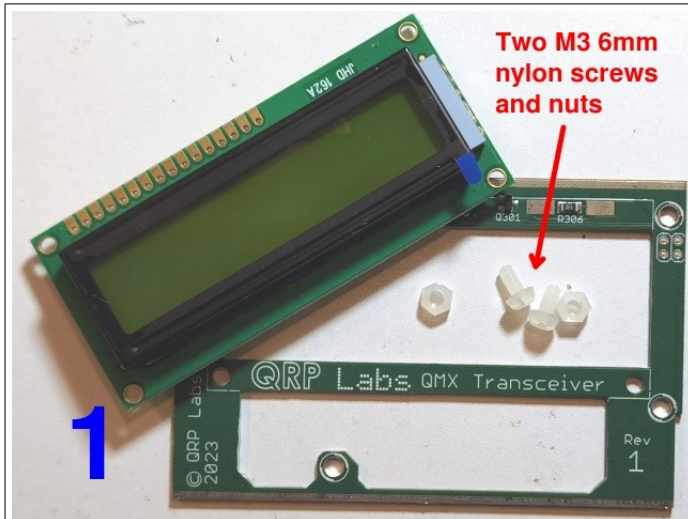

Identify the pairs of M3 6mm screws and nuts.

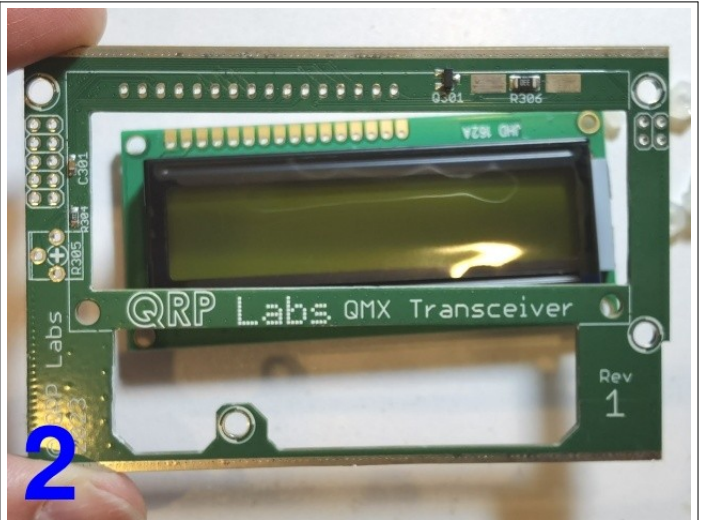

Fit the LCD module from behind the PCB, with its body through the rectangular cut-out

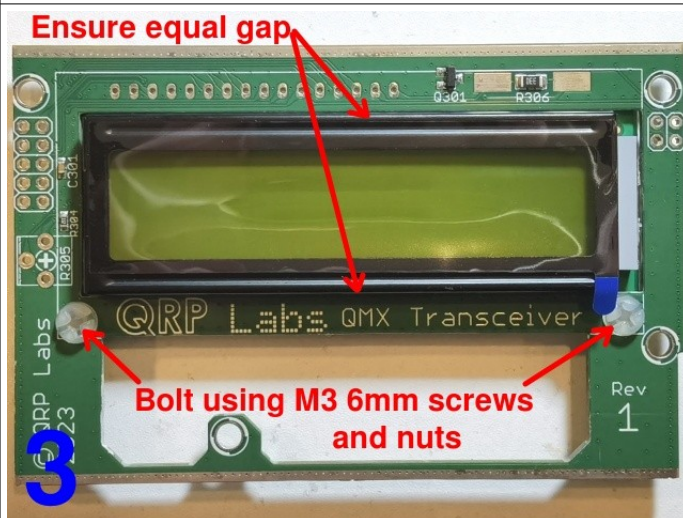

Bolt the LCD module, ensuring equal gaps at top and bottom; tighten screws firmly.

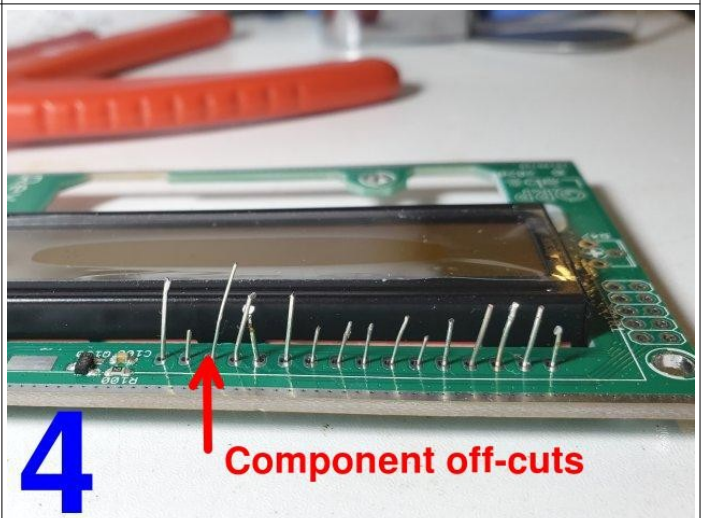

Drop component off-cuts through the 16 holes, their bottom ends sitting on the bench

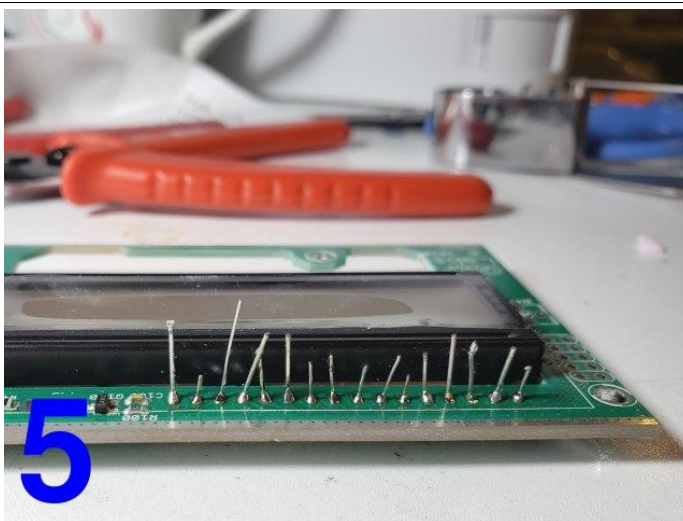

Solder the component off-cut wires to the top of the PCB and trim (cut) the excess wire.

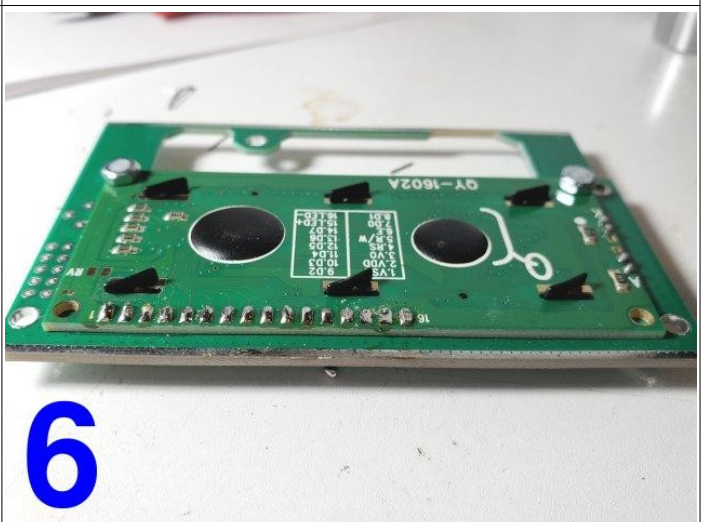

Turn over the PCB. Ensure the LCD sits flat on the PCB before soldering; trim excess.

2.19 Install 2x5-pin and 2x2-pin male pin header connectors

Install the 2x5-pin male header from below the display PCB; the short-end of the pins should be inserted through the PCB from the bottom side, as shown. Solder one pin first, and check alignment before continuing with the other nine. Try to ensure that the pin header sits squarely and centrally in its allocated position. Install and solder the 2x2-pin male header similarly on the right-hand side of the board.

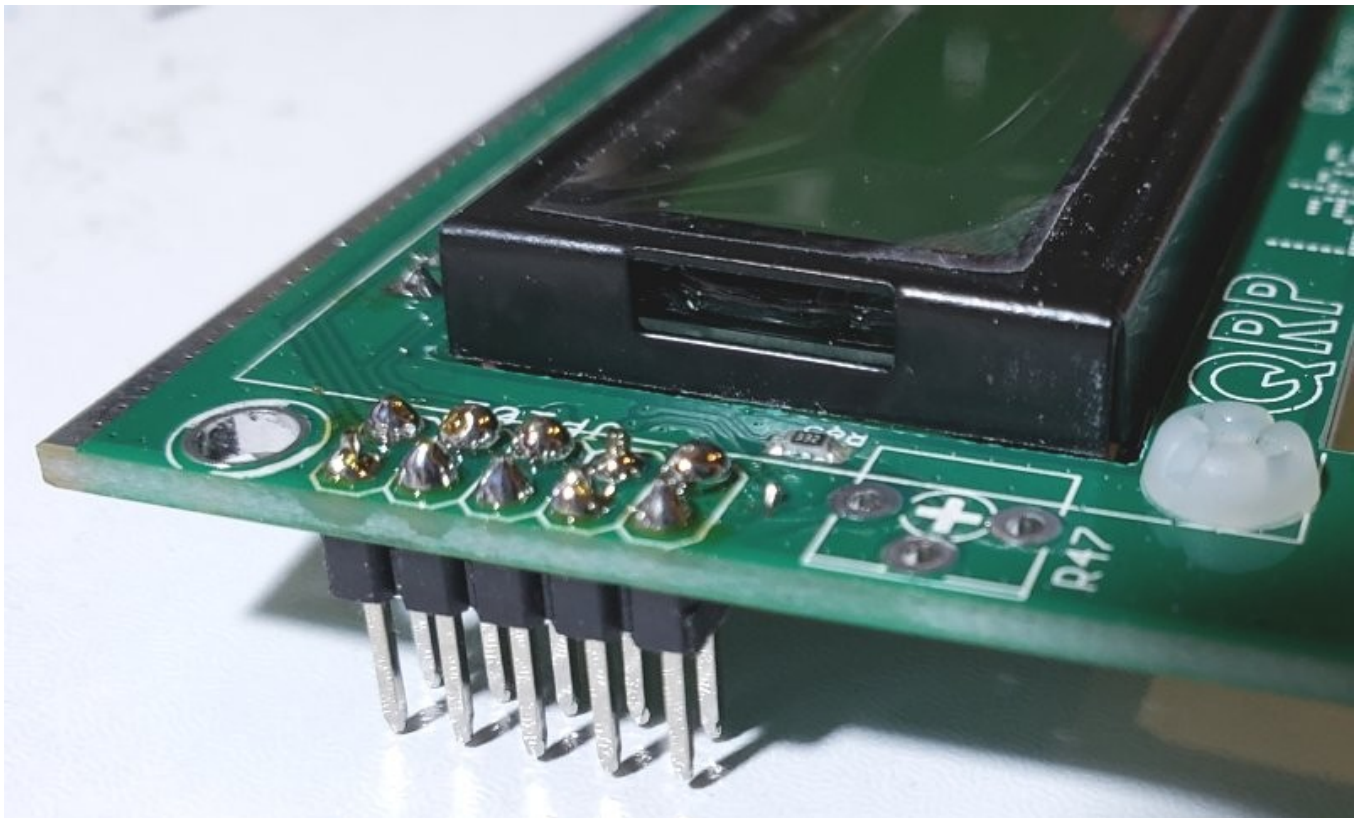

2.20 Install four 11mm nylon spacers

Install four 11mm nylon hex spacers on the underside of the LCD PCB using four 6mm nylon screws as shown.

Ensure the hex spacers are positioned such that a flat side is parallel to the nearby PCB edge, so that no corners overhang the edge of the PCB, which would prevent the enclosure end panels fitting.

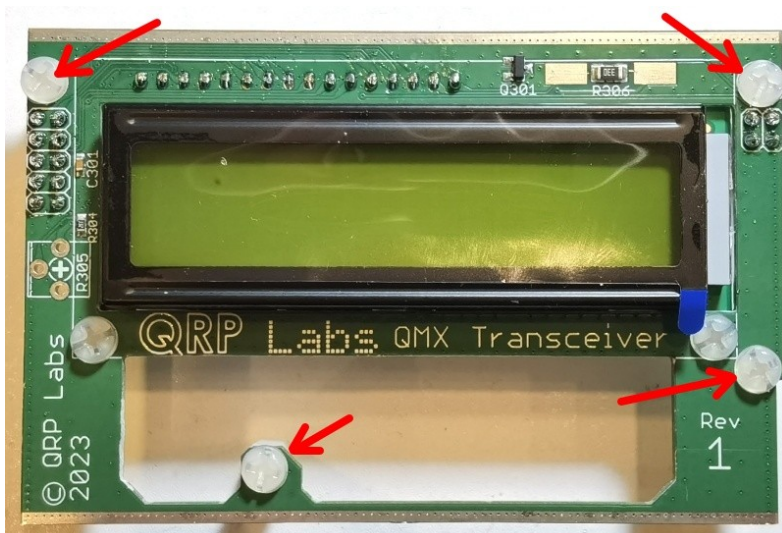
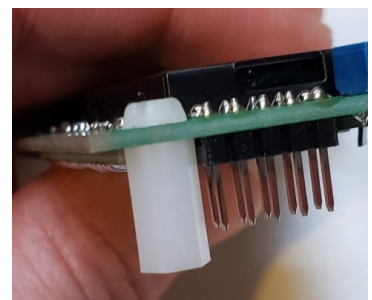

2.21 Install 20K trimmer potentiometer R305

The 20K single-turn trimmer potentiometer allows adjustment of the LCD contrast.

This potentiometer has four little feet, one in each corner. Unfortunately these make the trimmer too high and it may prevent the PCB from sliding into the QMX-mini enclosure later. Therefore it is necessary to cut off the protruding feet using a wire cutter, so that the potentiometer can sit flat on the PCB.

Follow the steps below to install this part.

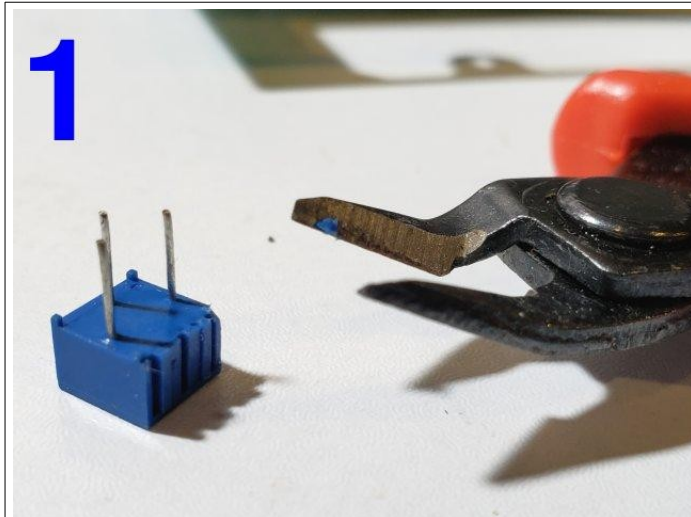

1 Cut each little plastic foot using wire-cutters.



2 It doesn't matter if the corner of the potentiometer body is damaged slightly.

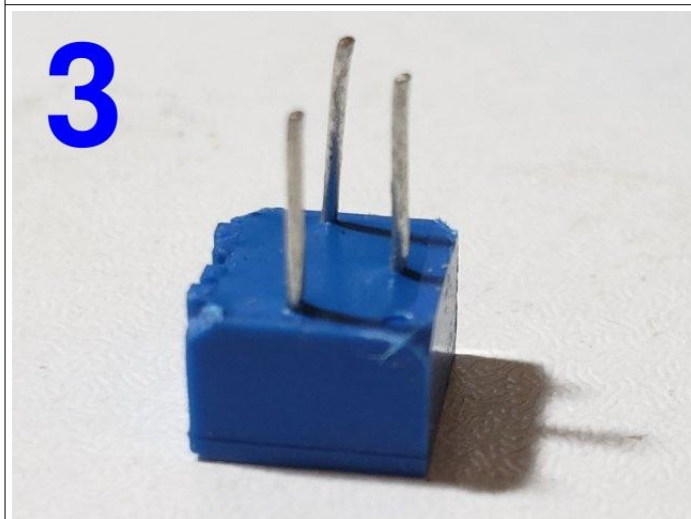

3 In the end it could look like this.

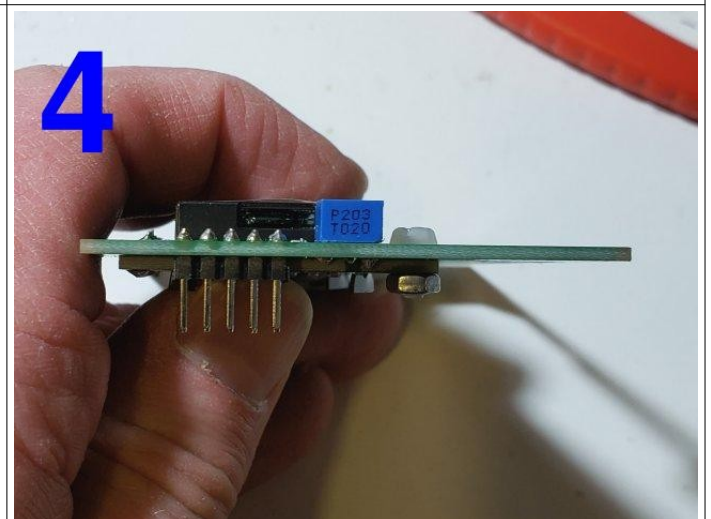

4 Install and solder, with the potentiometer body sitting flat on the PCB as shown. Trim excess pin length from the bottom side.

2.22 Install 2x4-pin male header on controls PCB

Next comes the assembly of the controls PCB, which holds two rotary encoders and the two tactile switch buttons.

The supplied 2x4-pin header has longer pins (about 17mm).

The 2x4-pin header must be installed with the small spacer PCB (see photo, right) sandwiched between the connector body and the underside of the PCB. Carefully follow the steps below to install this part.

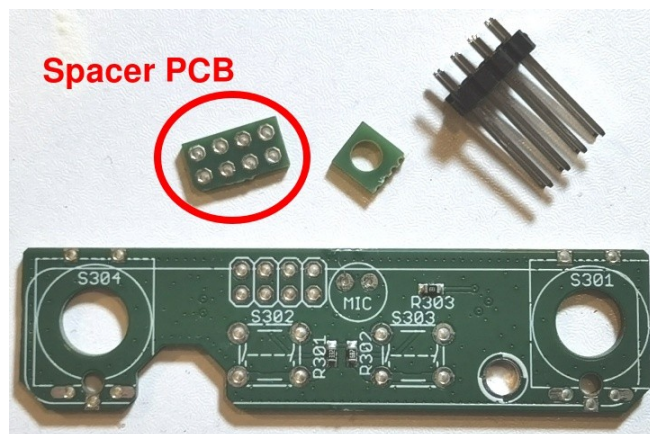

1



Insert the long pins into the 2x4-pin header socket (that will already be installed on the main QMX PCB, in reality, but is shown separately here for clarity).

2

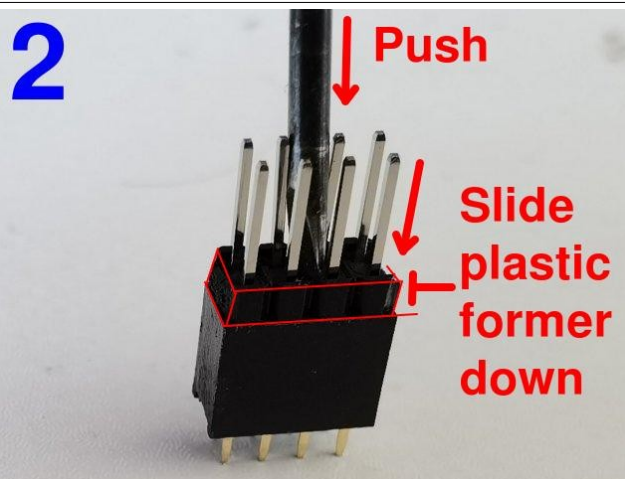

Use a screwdriver to firmly push down on the plastic former of the 2x4-pin header as shown, to slide it down the long pins until it sits flush on the 2x4-pin socket body.

3

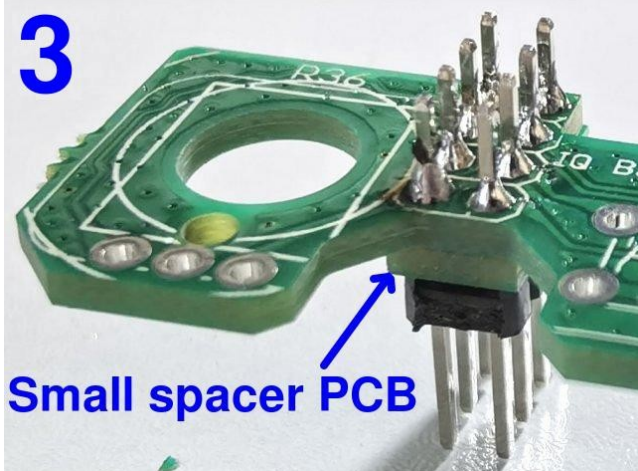

Thread the small spacer PCB onto the top side of the pins, and insert them into the controls PCB from below (silkscreen up, as shown), then solder carefully on the top side, ensuring no shorts. **The spacer PCB is important! Don't forget it to install it!**

4

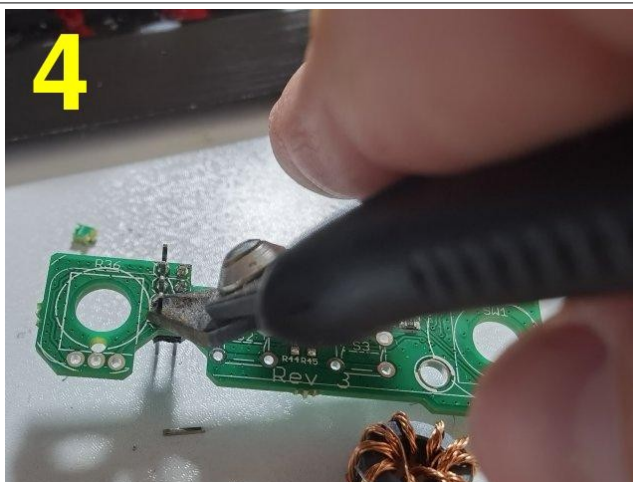

Use wire cutters to cut off the excess length of the long pin headers. They need to be trimmed otherwise they will risk touching the metal of the enclosure when the QMX is installed in its enclosure.

2.23 Install rotary encoders

Each rotary encoder is installed on the controls PCB, according to the following steps:



First cut off two large PCB-mounting lugs as shown using wire-cutters. Do NOT cut pins.



Position a flat-headed screwdriver above one of the five switch pins.

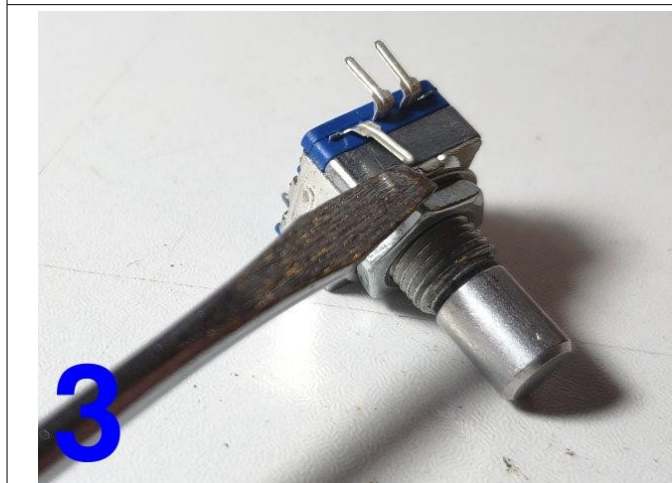

Bend over the pin through 180-degrees so that it points to the front of the control.



Repeat the same procedure for the four remaining pins.

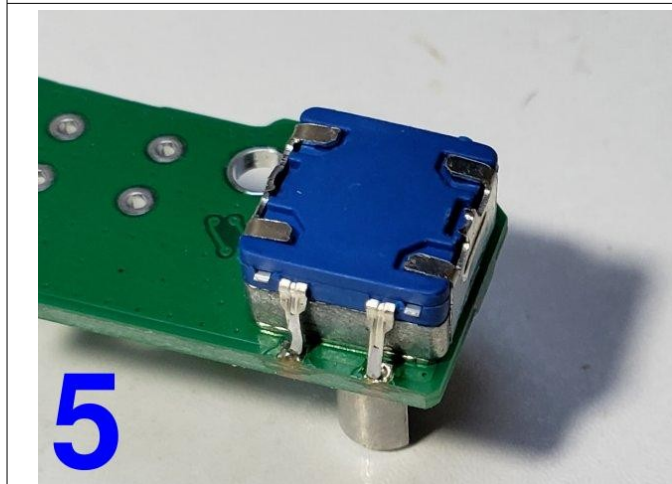

Install the rotary encoder, first line up pins so that they fit in corresponding PCB holes. The rotary encoder has a locating tab which fits into a matching hole on the PCB.

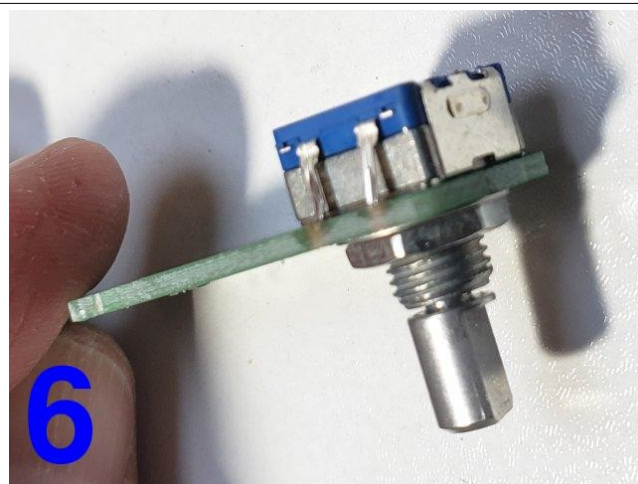

Make sure the nut is on the "top" (silkscreen-printed) side of the PCB. Do not use the washer. Tighten the nut.

7

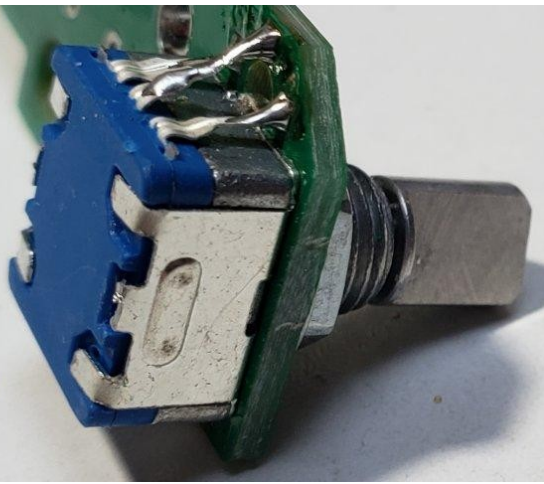

Solder each of the five switch pins, on the underside of the PCB (the side with the blue body of the rotary encoder). The center pin of the three may benefit from a piece of wire off-cut to extend it to reach the PCB hole.

2.24 Install tactile switch buttons

The two buttons should be installed on the control PCB as shown. These have four pins on a rectangular footprint that can only fit into the PCB one way. The only special precaution to observe here, is to make sure that the switch button is seated squarely on the PCB, so that the shaft is perpendicular to the PCB. Solder two diagonally opposite pins first then check the alignment and make any adjustments necessary; when all is well, solder the two remaining pins.

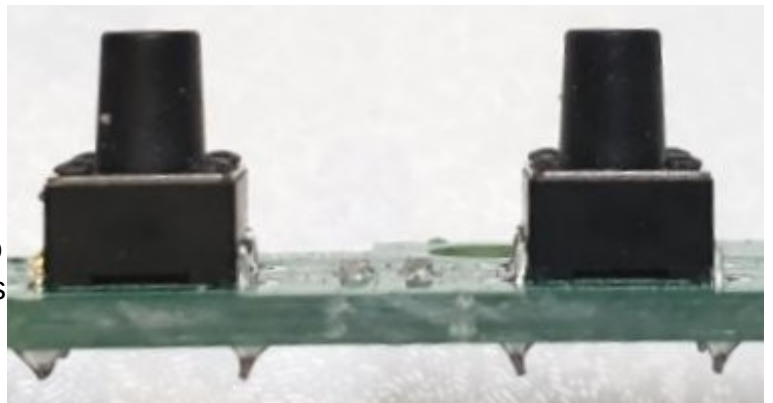

2.25 Install electret microphone

The QMX kit contains an electret microphone which will facilitate future SSB mode support. Install and solder the supplied 6mm electret microphone on the controls PCB. The pins need to be spread apart slightly and it will not sit completely flush on the PCB. **Microphone POLARITY is critical! It is essential to fit the microphone so that the pins fit exactly in the silkscreen circle as shown below.**

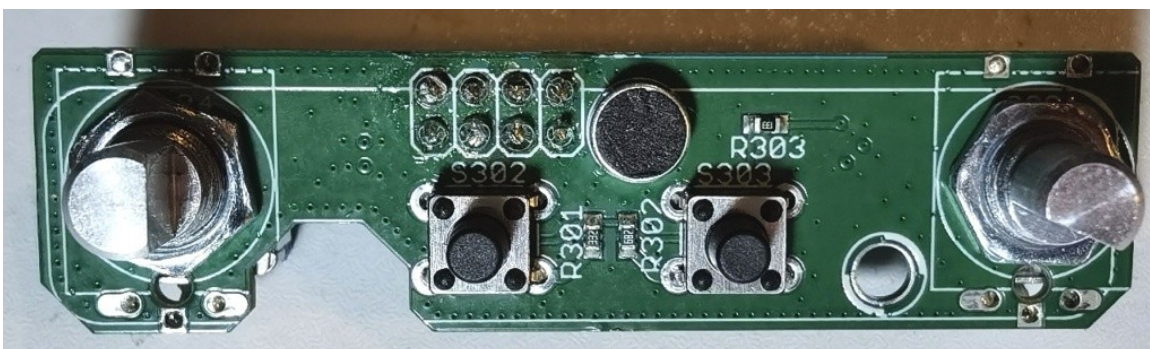

2.26 Install 11mm nylon hex spacer

The final 11mm nylon hex spacer is bolted to the controls PCB using an M3 6mm nylon screw. Push the screw through the hole from the front side of the PCB. Thread the small square spacer PCB that was broken out from the Display PCB panel, onto the screw. Then screw on the 11mm nylon spacer.

This completes the Controls PCB assembly.

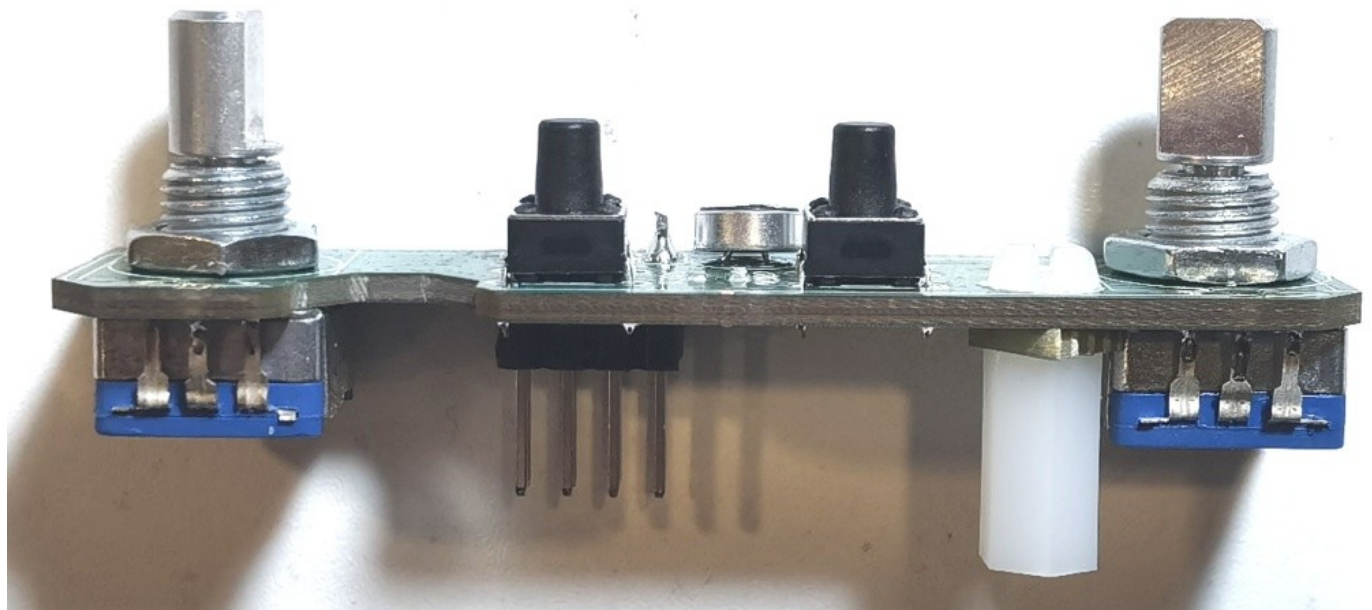
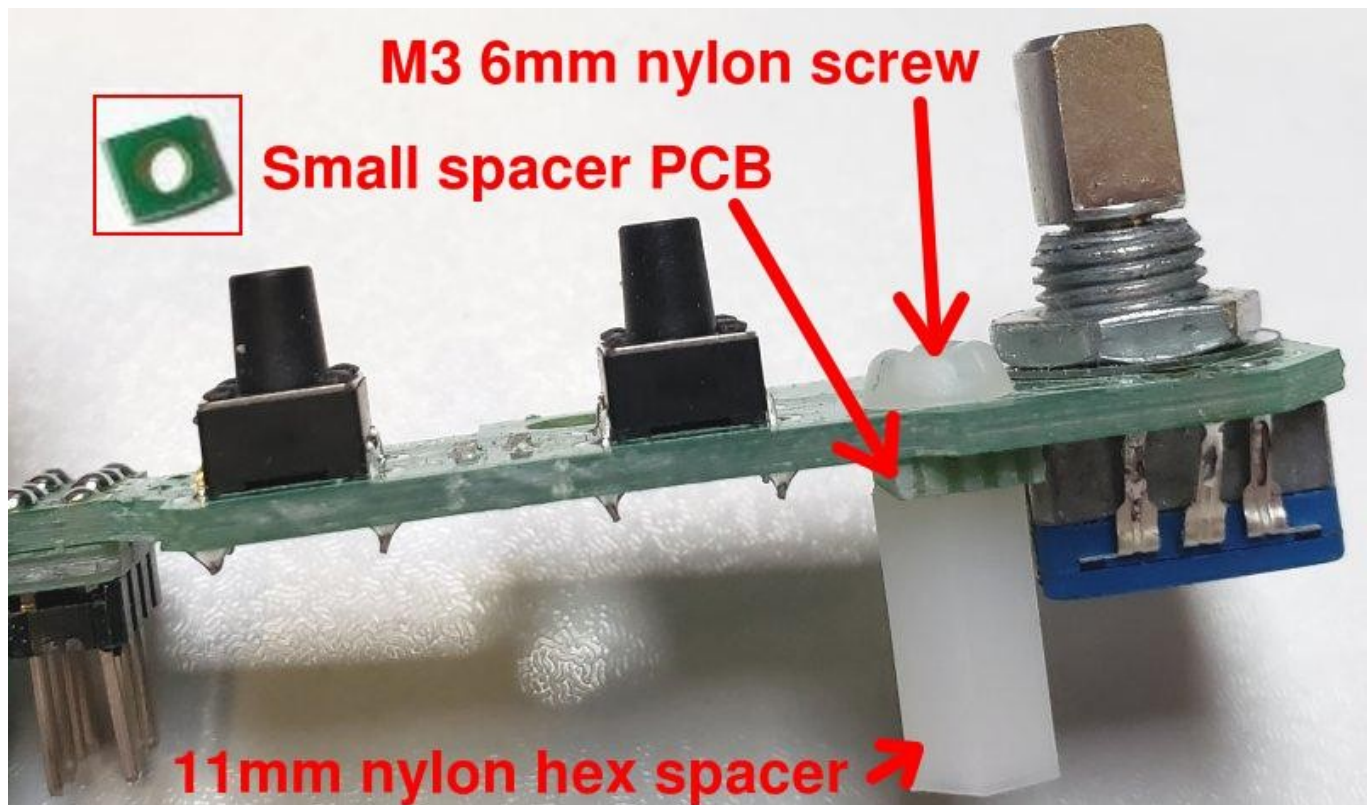

2.27 Fit Controls PCB to main PCB

Now fit the Controls PCB to the main PCB by plugging together the two 2x4-pin header connectors.

Fit an M3 6mm screw from the underside of the main PCB, screwed into the 11mm nylon hex spacer pillar that is fixed to the Controls PCB, as shown in the following photograph.

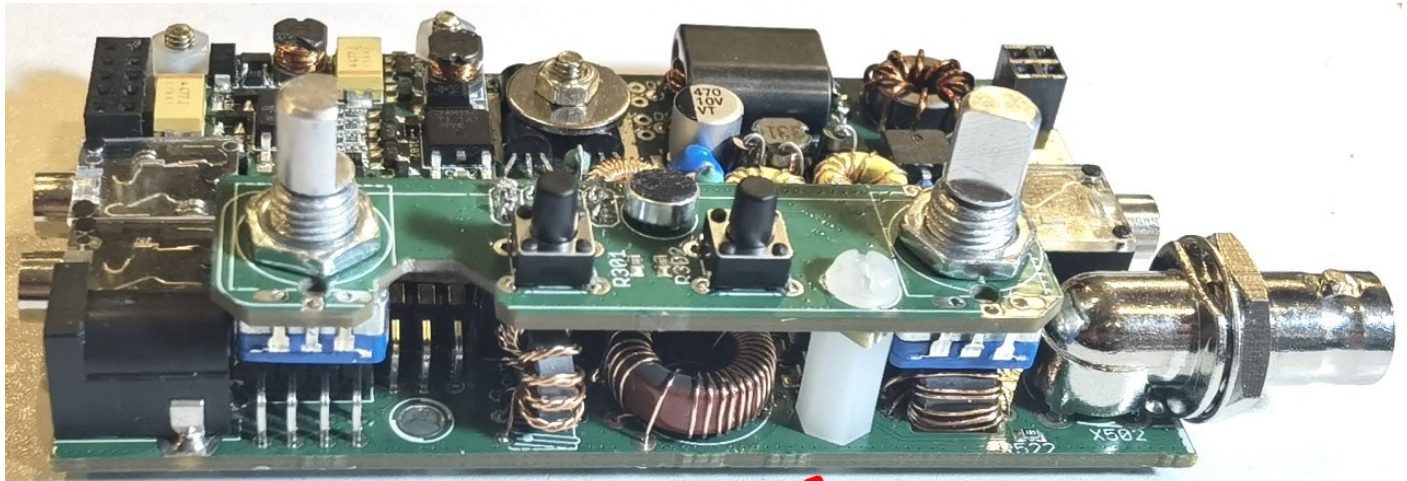

Fix using M3 6mm nylon screw ↗

2.28 Plug together the boards

There is a mechanical conflict between the black metal LCD module assembly retaining tab nearest to the 2x5-pin header, and one of the 330uH inductors on the power supply boards.



This tab needs to be bent over about 45-degrees so that it no longer gets obstructed by the 330uH inductor.

Now you can carefully plug together the two circuit boards. The best way to do this is to concentrate on getting the 5-pin headers at the top left of the PCBs, and the 2-pin header at the top right, to mate accurately with each other. The rest should fall into place by itself.

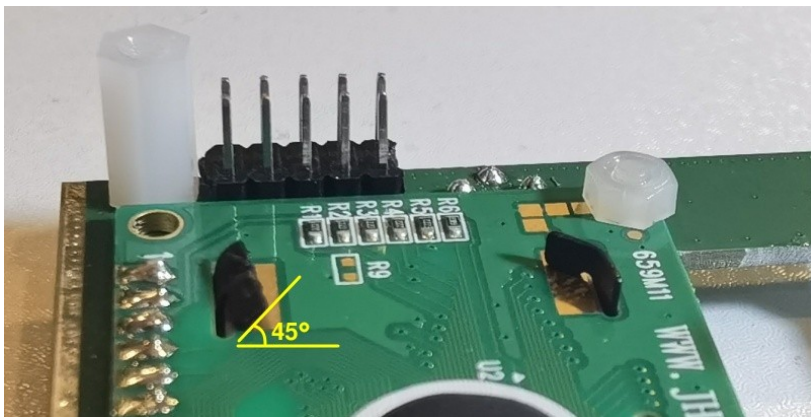

If you have taken care particularly with filing off the rough edges of the PCBs when the Display board panel was broken out into the sub-PCBs, then you should find that the Controls PCB will fit perfectly (though snugly) through the gap in the Display board, and it will be elevated 1.6mm (one PCB's thickness) above the Display board.

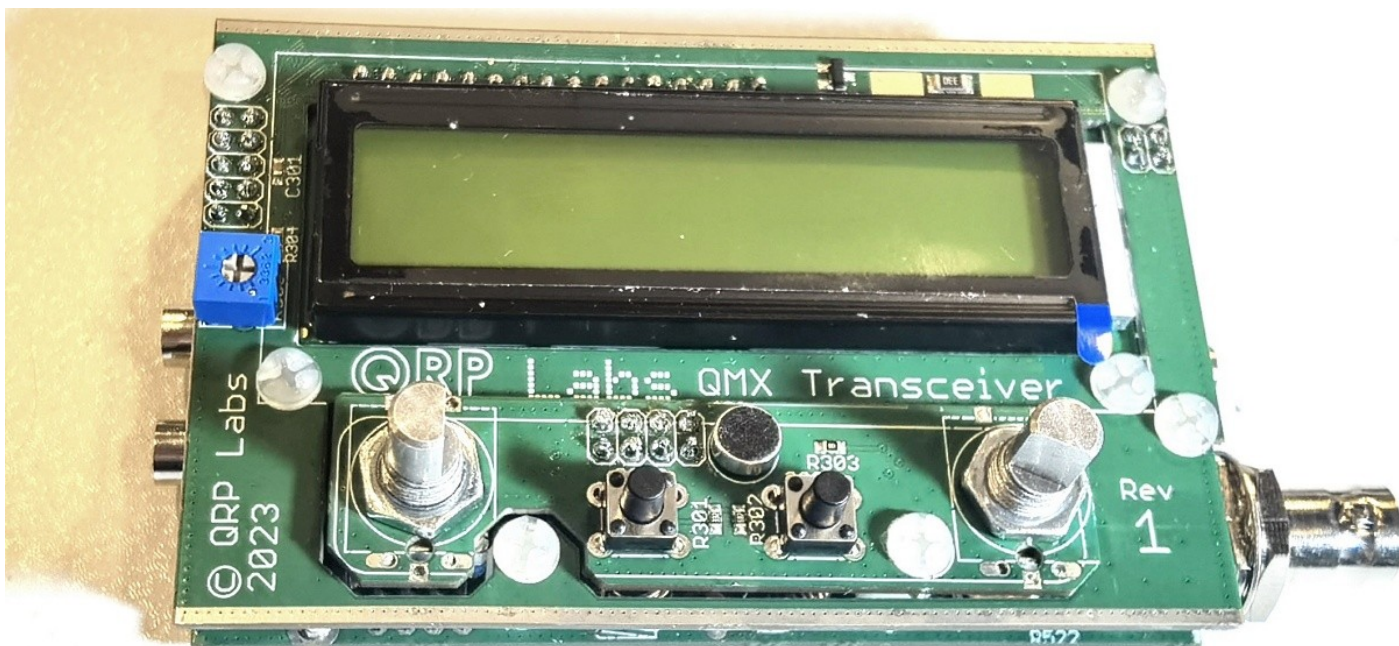

2.29 QMX GPS interface and PTT output

The picture below shows the connectors on the main QMX PCB.

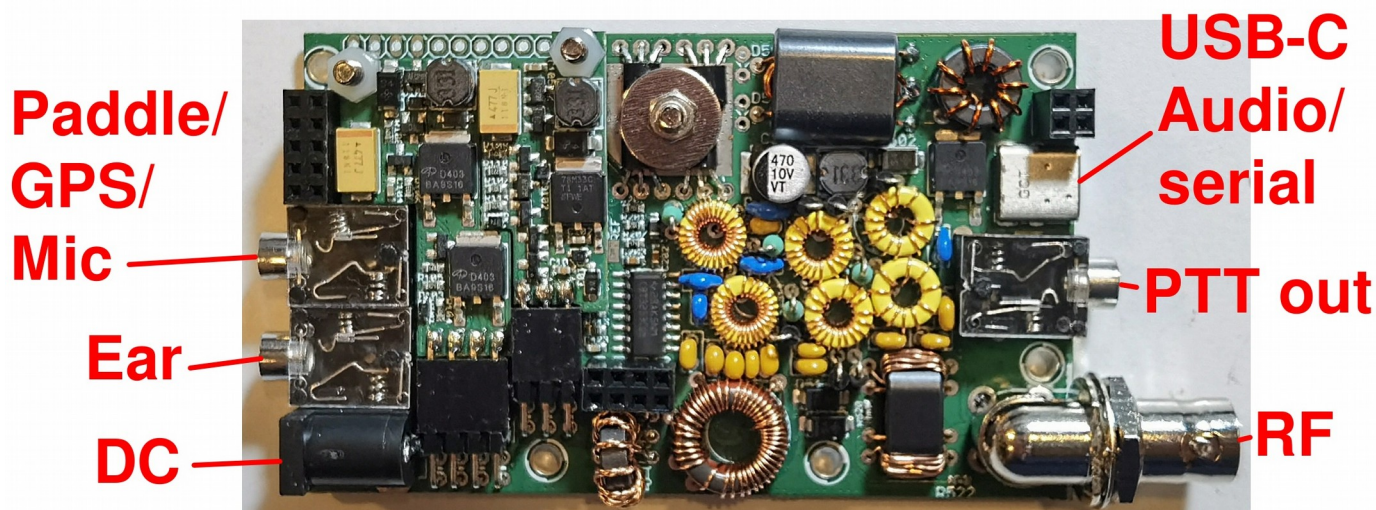

GPS interface

The QMX transceiver has a GPS interface which can be used to:

- Calibrate the 25MHz TCXO reference oscillator
- Keep the oscillator disciplined and drift-free (frequency and time) during WSPR beacon operation
- Set the internal Real Time Clock, which is critical for WSPR options and may be displayed on-screen if you have configured it.

The GPS produces two output signals, PPS (Pulse-per-second) and RxD (Serial data). A GPS such as the QRP Labs QLG2 is perfect for this see <http://qrp-labs.com/qlg2>

QMX cannot supply +5V for the GPS unit; you need to provide that separately.

The GPS signals (PPS and RxD) use the same microcontroller pins as the paddle Dah and Dit respectively. Therefore you cannot use the Paddle and GPS at the same time. In fact, you should only connect the GPS during the calibration of the reference frequency, and while operating the QMX as a beacon (CW, FSKCW or WSPR).

The following diagram shows the connections.

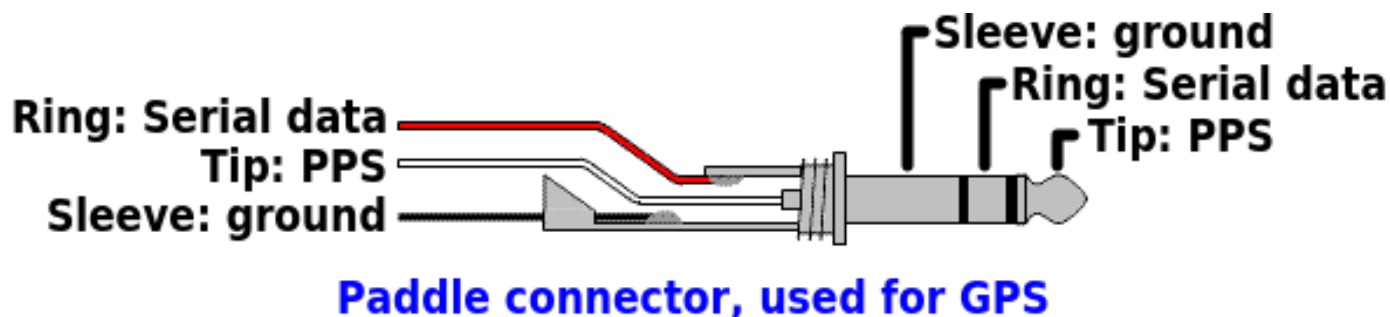

PTT output

The QMX PCB has a 3.5mm stereo jack as PTT output.

The “Tip” connection is pulled to ground during transmit, when Q13 is switched on by the microcontroller.

The “Ring” connection is pulled to +5V during transmit when Q12 is switched on by the microcontroller.

A common standard 3.5mm stereo audio cable with 3.5mm plugs at each end may be used without modification between the QMX and the QRP Labs 50W PA (which uses the positive-going +5V signal on the “ring” and makes no connection to “tip”).

During transmit, the microcontroller activates ONE of the PTT signals; you may configure which one, according to your needs.

It should be noted that:

- The QRP Labs 50W PA may not be used in high duty cycle modes such as FT8, JS8 etc at full power. It should be de-rated to half power operation at maximum, by using a 12V or 13.8V supply. Caution is advised.
- The 50W PA kit has a built-in Low Pass Filter and is designed for single band operation only.
- The PTT output must be enabled per band, by connecting a terminal emulator to QMX. Refer to the operation manual for details.

2.30 FINAL CHECKS BEFORE APPLYING POWER THE FIRST TIME!

It's very highly recommended to check everything very carefully before applying power, as follows:

1. Look over the entire board with optical magnification and look for any dry joints, solder bridges or whiskers, components which were not soldered properly, etc.
2. Turn the contrast trimmer potentiometer on the display board (left of the LCD) fully ANTI-clockwise initially; at the default adjustment there will be no text visible on the display!
3. Note that the QMX is normally supplied without firmware and you must install firmware first, before anything will happen (see subsequent section after finishing this "final checks" section).
4. Check that there is no short-circuit between the body of the left rotary encoder, and the DC input jack power connector. If necessary, apply a small piece of insulating tape to prevent a short-circuit.
5. The plug-in buck converter boards are critical, because they supply power to the 3.3V and 5V rails. If there are any faults here, it could destroy your QMX instantly.
6. Check the soldering of the 2x4-pin and 2x3-pin right-angled headers which connect to the plug-in buck converter boards. Look for dry joints and any solder bridges or other faults. Check the "edge connected" female pin header sockets on the plug-in boards themselves – are all the pins properly soldered, and no accidental solder bridges between pins?
7. Make sure the two buck-converter boards are properly plugged in, and each one is secured with its retaining screw (10mm M3 plastic screw and two M3 plastic nuts). The QMX cannot function without the two buck-converter boards.
8. Make sure that the controls board connector is properly soldered in and the board is installed correctly and secured with its mounting pillar and screw; the left rotary encoder shaft button must later be pressed (long press) to switch on the unit (see next section).
9. When you apply power to your QMX for the first time, it is a very good idea to use a lower supply voltage than you intend to run at, perhaps 7V for example; and use a current-limited supply if possible, perhaps limited to say 250mA. If there are any problems, this will minimize the probability of damage.
10. When you do finally dare to apply the power, you should see ZERO current consumption, and nothing happen; then press the left rotary encoder button; with a USB cable plugged in, QMX should appear the first time as a USB Flash drive (memory stick) so that you can install the firmware.

2.31 Connections for basic operation

The following connections are required for basic transceiver operation.

PLEASE READ PRECEDING SECTION before applying power.

1) Power supply

A power supply is required, which needs to be able to supply up to 1A approximately, on transmit. The supply voltage may be from 9V or 12V depending on how you wound the output transformer T501. If the voltages fall, the RF output will be correspondingly lower. Operation much above 5W output is not recommended and could lead to overheating and destruction of the final amplifier.

A 2.1mm DC connector plug is required; the center pin is + and the barrel is ground (negative).

2) Earphones

The earphones can be any stereo earphones such as commonly used with audio equipment, mobile phones and so on, with a 3.5mm stereo jack plug. These commonly have a 32-ohm impedance. The output op-amp IC (IC10) is not able to supply the required power output for loudspeakers.

If you want to use a small loudspeaker you will need to ensure this is an “amplified speaker” because the audio output will not be strong enough to drive a speaker directly.

3) Antenna system

The RF output is a filtered 50-ohm BNC output for connection to a usual antenna system (antenna, and matching unit if applicable).

4) Straight key or paddle

To operate the QMX transceiver a straight key or paddle should be connected to the appropriate jack, having a 3.5mm stereo jack plug. The shield (or main body) is ground. It does not really matter which way around the tip and ring connections are (to dit or dah of the paddle) since if they are the wrong way, there is a menu configuration item to swap them around. Similarly if using a straight key, you can select in the firmware either tip, ring or both for the connection; this allows use of a 3.5mm mono plug when using a straight key.

2.32 Firmware installation

Use firmware 1_00_011 and above for PCB Rev 2 QMX!

Your QMX is supplied with the bootloader installed, but not the firmware. Installation of the latest firmware revision is absolutely required before your QMX will do anything at all.

On occasion QRP Labs will make available updated firmware for QMX, in order to deliver bug fixes or functionality enhancements. Firmware updates are always freely available to all QMX owners, and may be downloaded from the QMX web page <http://qrp-labs.com/qmx>

QMX contains a the standard QRP Labs firmware update procedure for STM32-series microcontrollers, called QFU (QRP Labs **F**irmware **U**ppdate) which provides the following features:

- **Easy** – anyone can do the firmware update
- **No additional hardware required:** only a standard USB-C cable
- **No additional software required:** just the standard file manager application that is already available on any PC
- **No drivers:** no special drivers need to be installed, the existing drivers on any modern PC operating system are used
- **Works on any PC Operating System:** and in the same way: Windows, Linux, Mac
- **Secure:** firmware files are published on the QRP Labs website and are encrypted using 256-bit AES encryption technology

Entering bootloader (firmware update) mode:

Note: you have to switch on QMX by pressing the left rotary encoder shaft button! In firmware update mode, the LCD is blank and the backlight is off.

QMX provides four possible ways to enter firmware update mode:

1. The first time you power up your QMX, there is no firmware on the QMX. It will automatically enter firmware update mode and stay in firmware update mode until you have successfully installed the firmware.
2. Select the “Update firmware” option in the QMX in the “Other” sub-menu of the configuration menu system on the QMX itself.
3. Select the “Update firmware” menu option in the QMX Terminal (refer to operating manual). QMX will then enter firmware update mode.
4. Connect a wire jumper from Aux2 to Ground (see details below) to force firmware update mode.

Exiting bootloader (firmware update) mode:

QMX provides two possible ways to exit firmware update mode:

- 1) Update the firmware! After updating the firmware, QMX will automatically reboot in normal operating mode.
- 2) Power down QMX, and re-apply the power again. QMX will reboot in normal operating mode (as long as a valid firmware file has been installed, at least the first time you use QMX).

USB Flash memory stick emulation:

In the firmware update mode, the QMX pretends to be a USB Flash memory stick, having a 4MByte capacity and implementing a FAT16 file system. This virtual “Flash stick” contains two files:

1. the firmware program file of the QMX microcontroller. You may read the file from QMX, or write a new one, just by dragging files in your file manager application.
2. EEPROM contents: the QMX configuration and log file (if enabled). Again, you can read the file from QMX or write a new one to QMX, simply by dragging files in your file manager application.

On entering the Firmware update procedure, a pop-up window should appear on your PC. On my system (Linux XUbuntu 18.04) it looks like this:

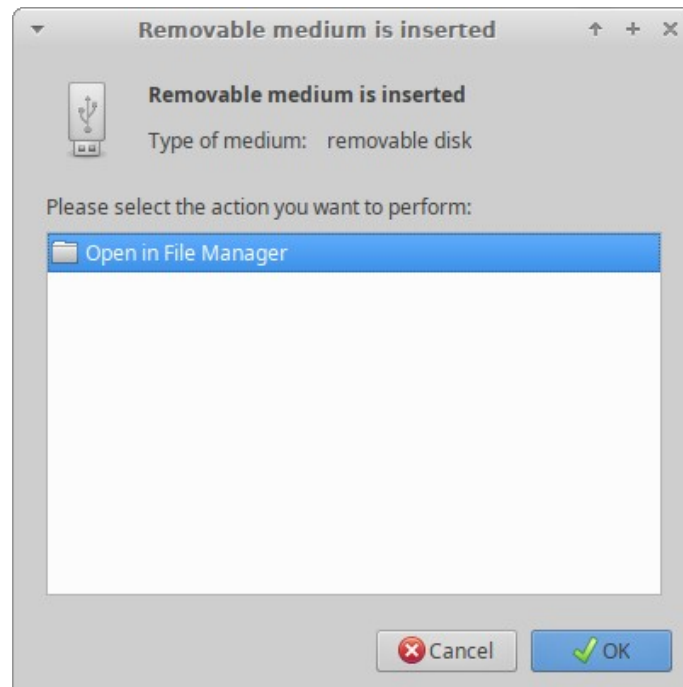

Click the OK button.

The File Manager window will then open, and on my system looks like the screenshot on the following page.

QMX appears as a removable USB Flash device named “QMX”, and the folder two files. The firmware file in this example is named shows a single file which is the firmware version file, 1_00.QMX in this example. The EEPROM file is always named EEPROM. You can read and write EEPROM files in order to make and restore backup copies of your configuration etc.

The firmware file name must not be longer than 8 characters, and cannot contain punctuation or spaces; the file extension must be no more than 3 characters. This is because the file system emulation is FAT16 and these are the specifications of the FAT16 format.

You may check the properties of the file and will note that it is a 529 KBytes file.

QMX firmware images are always a 529K file. The creation date and modification date etc. have not been set, because it was important to minimize the size and complexity of the QFU bootloader, in order to maximize the space available to the application firmware.

You may copy the existing firmware file to another directory of your computer. Crucially, to do the firmware update, all you need to do is copy the new firmware file to this QMX “Flash disk”.

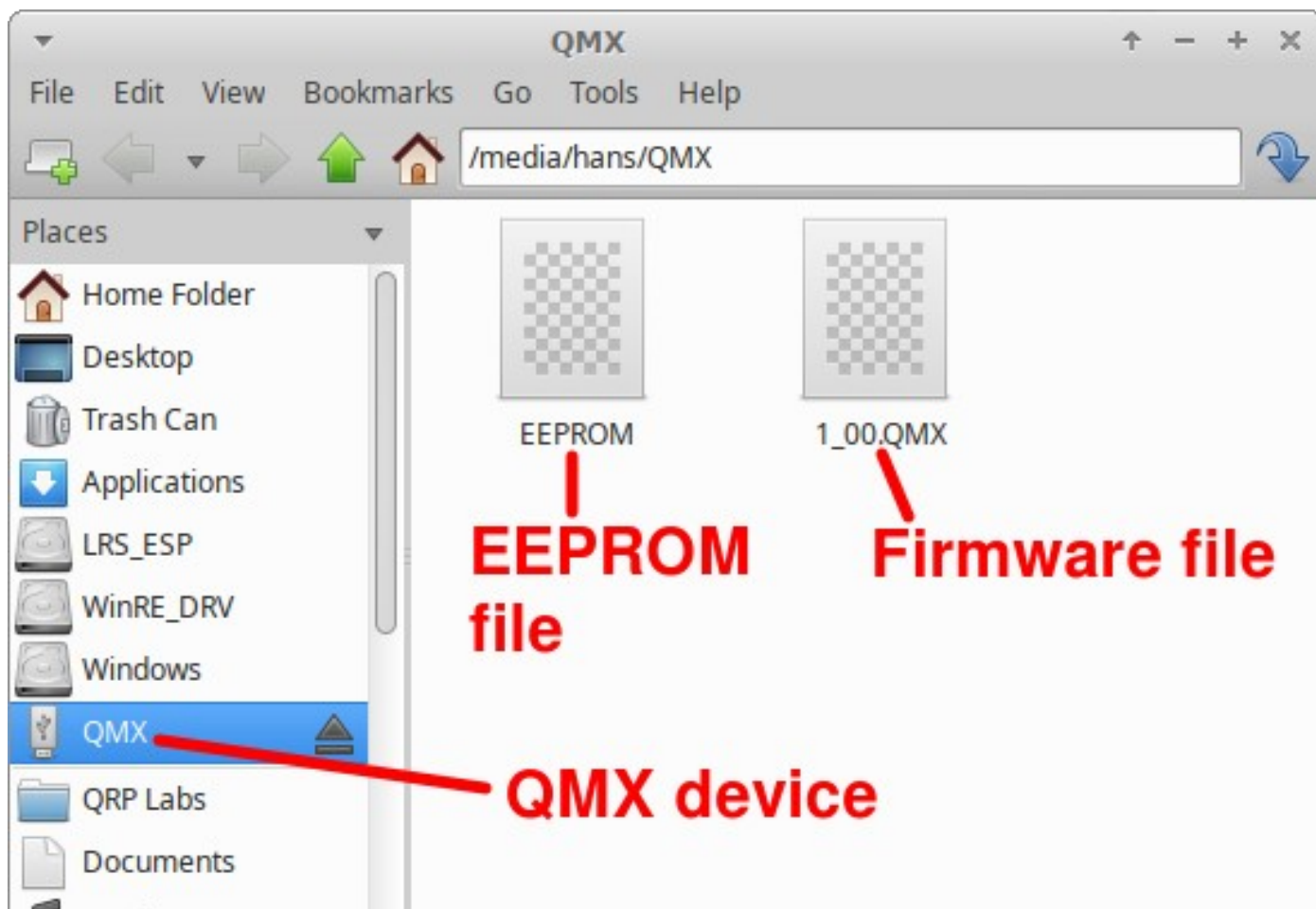

Download the new firmware file from the QRP Labs website at <http://grp-labs.com/qmx>, unzip it, and simply drag it into the folder where the existing firmware file version is shown. Or copy and paste it, however you wish.

The file on the QRP Labs website is a ZIPPED file, please be sure to unzip it to get the .QMX file before copying it to QMX.

As soon as you copy the new file to the QMX QFU “flash drive”, the QMX QFU bootloader erases the current program from its memory and installs the new one.

The QMX firmware is 256-bit AES encrypted and this means:

- The encrypted QMX firmware file will only work on a QRP Labs QMX board, it cannot be installed on any other board, even one containing the same processor.

- No other firmware file will work on the QRP Labs QMX board except an official QRP Labs encrypted QMX firmware file.

The procedure will vary slightly for different Operating systems but in all cases is just a simple matter of copying the new firmware file to the emulated QMX QFU USB Flash drive.

On booting up for the first time, the QMX screen contrast adjustment will be required; QMX will then ask you for your choice of version, use the right-hand rotary encoder to select the version you built (for example 80-20m) then press the left button to select it. If you chose the wrong band version, you can always get back to this selection using by executing a Factory Reset. Please refer to the operating manual for further details.

The above firmware update procedure works on ANY modern OS because the QFU bootloader emulates a USB Flash memory stick with the USB Mass Storage Device (MSD) class, for which drivers are already present.

The QFU bootloader implements a USB device stack (Mass Storage Device class), emulated FAT16 file system, Flash erase/write, and 256-AES encryption.

Forcing firmware update mode using wire jumpers

If for any reason, the firmware update did not execute correctly, you cannot access either the user interface on the QMX or log in via the terminal, and you need to force the unit to re-enter firmware update mode – you can do this by connecting a wire jumper from the Aux 2 pin to Ground (see diagram below) then re-starting QMX (cycle the power supply voltage). QMX will remain in bootloader mode until you remove the wire link.

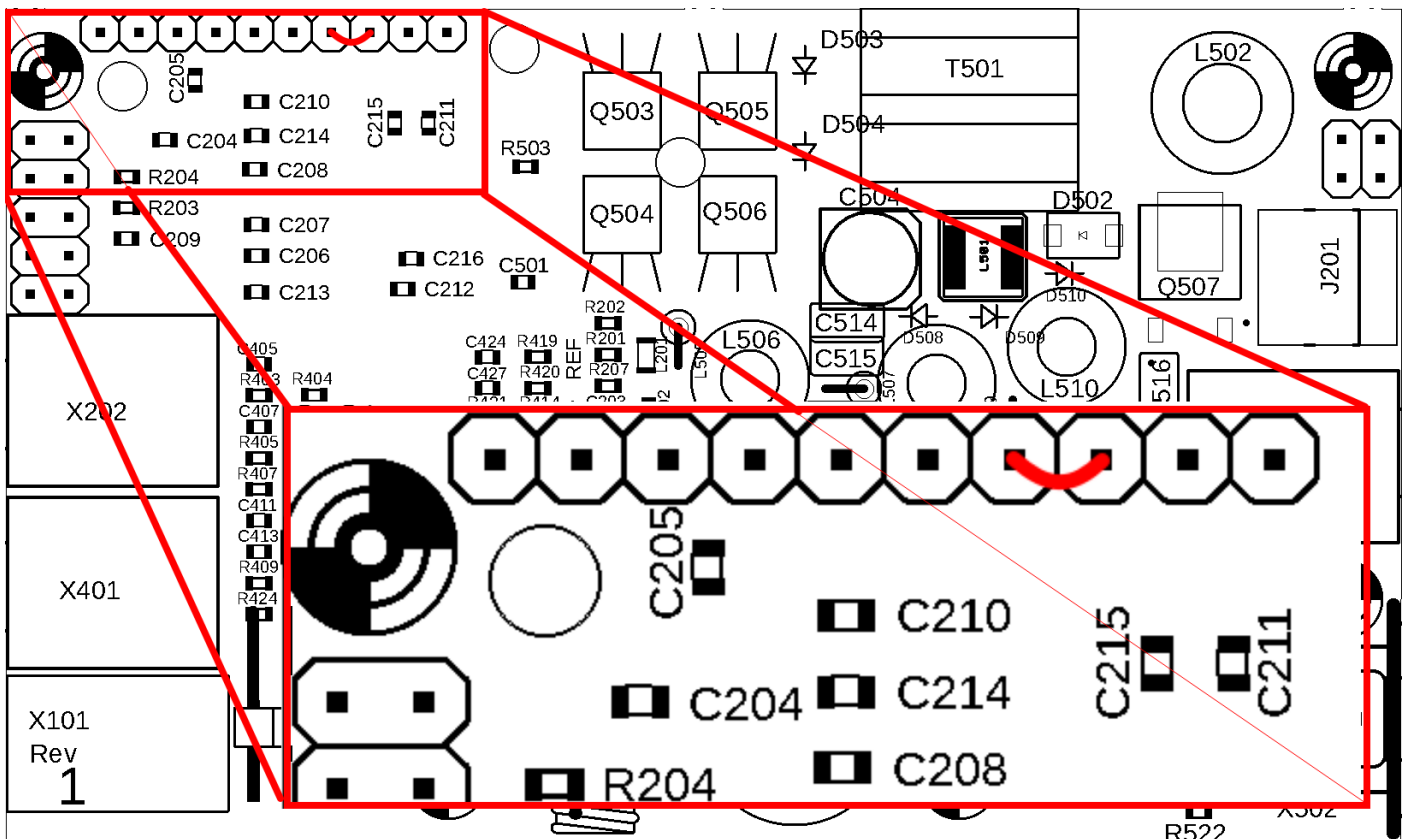

2.33 Optional enclosure

Installation in the QMX enclosure is simple and requires no wiring. It is important to do the assembly in the correct sequence, as follows (Photographs are from the similar QCX-mini).

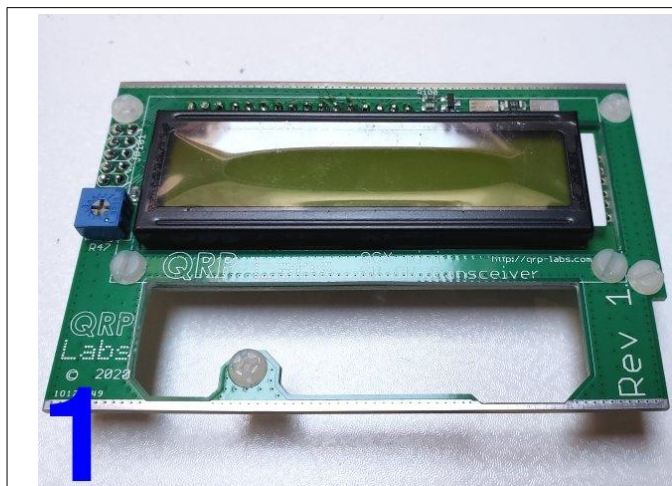

Start with the Display board...



... and the main board, with the controls board bolted in position.



Peel off the plastic protective coating from the LCD module.

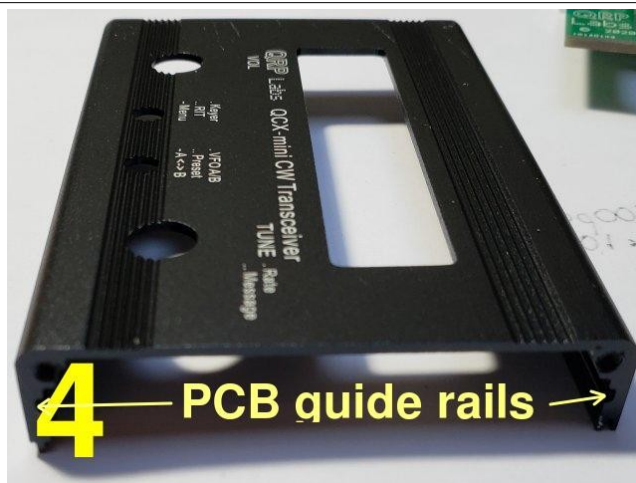

Here's the top half of the enclosure. Note the PCB guide rails in the extrusion walls.



Slide the display board into position along the PCB guide rails in the enclosure.



Bolt the right-hand side panel to the main PCB using the supplied BNC washer and nut

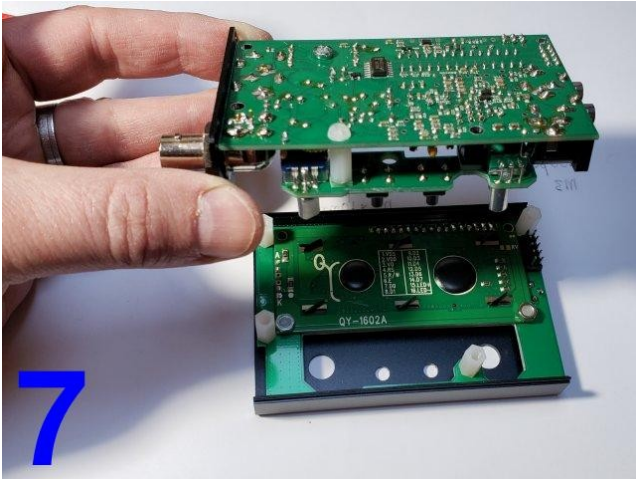

7 Place the front of the enclosure face down on the bench as shown, and prepare to attach the main board.

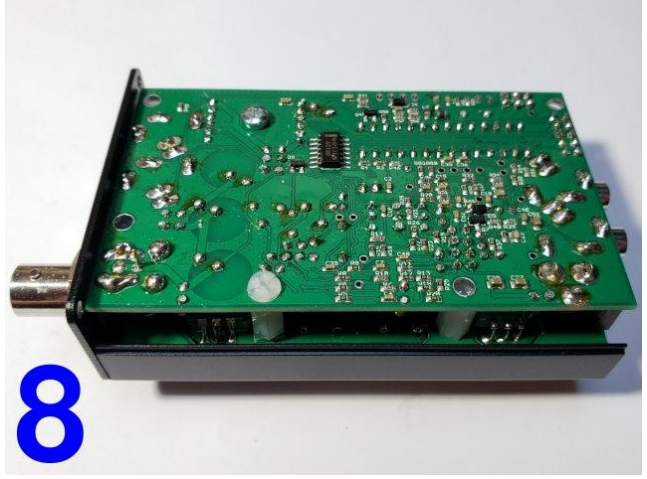

8 Align the 2x5-pin header connector between the main and display boards; some wiggling will be needed to get the controls to fit through the holes in the front panel.

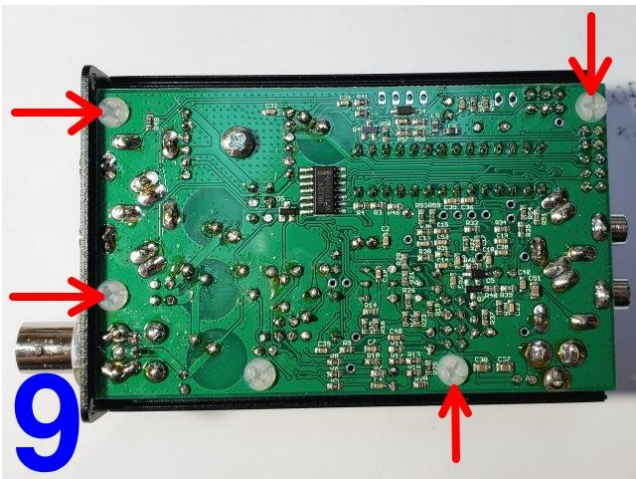

9 Fit four M3 6mm nylon screws in the positions shown



10 This is how it looks from the DC connector end

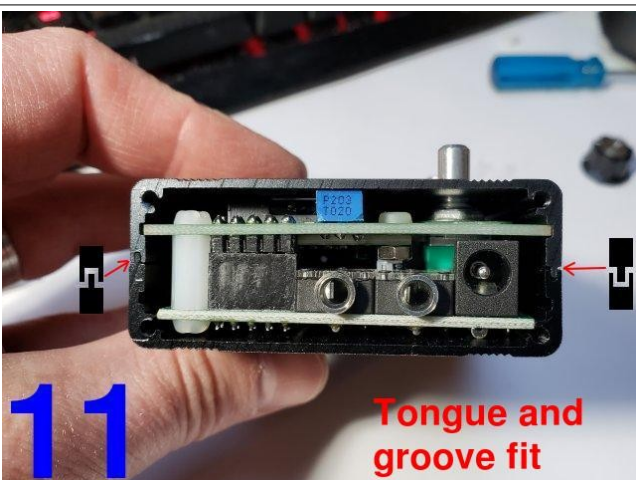

11 Determine correct orientation of the bottom half of the enclosure; note the tongue-and-groove arrangement which means that the bottom half only fits one way round! Make sure you have the correct way.



12 Now bolt the left-hand side panel to the enclosure extruded top and bottom halves using four of the supplied small black countersunk screws in the panel corners. The screws need to be carefully aligned and should screw in easily (if properly aligned).



Screw in the other four black screws in the corners of the right-hand side panel.



Apply the supplied four self-adhesive feet to suitable positions on the base of the enclosure if desired (optional).



Install the supplied knobs by tightening their grub screws. Leave a small gap between each knob and the front panel, to allow the knob to turn easily. The grub screw of the volume control knob should be at the position of the flat on the shaft. The grub screw position on the rotary encoder is not important.



Plug in the power...

SUCCESS!

(hopefully)

Disassembly of the QMX should follow similar steps, in reverse.

3. Resources

- For updates and tips relating to this kit please visit the QRP Labs QMX kit page <http://qrp-labs.com/qmx>
- For any questions regarding the assembly and operation of this kit please join the QRP Labs group, see <http://qrp-labs.com/group> for details

4. Document Revision History

1.00	04-May-2023	First draft
1.00a	24-May-2023	First official version
1.00b	25-May-2023	Some spelling mistake corrections and update to the page 59 photo
1.00c	25-May-2023	Clarification of diode polarity in section 2.6
1.00d	26-May-2023	Section 2.13 amendment (wire lengths) and page 20 BOM correction
1.00e	31-May-2023	Added first time checks section and other updates
1.00f	09-Jul-2023	Amended for modified L401 style (to remove 20m sensitivity problem); corrected error with the 180p and 270p capacitors in the LPF being swapped.
1.00g	18-Aug-2023	Added note about removing superfluous PCB rail material from manufacturing process. T1 wrongly named on page 4, changed to T501. Added more checks including Q103/Q104 short, before power up
1.00h	20-Aug-2023	Removed 22pF capacitor from BOM on p21 and p22 photo
1.00i	12-Sep-2023	P10 step 14, referred to 2.32, it is now correctly 2.33. P43, 10mm nylon nut should be (and now is) 9mm. Moved T501 preparation to a separate document. Removed the recommendation to drill out the SMPS spacer nuts Contrast adjustment pot corrected to R305
1.00j	24-Sep-2023	Corrected photograph caption in section 2.17 (no “de-threaded”)
1.01	28-Nov-2023	Manual for Rev 2 PCB QMX assembly
1.02		Fix mix-up of red/yellow L401 for high/low band versions
1.02a	10-Feb-2024	Add note on page 45 regarding the grounded PTT modifications
1.04	08-May-2024	Manual for Rev 4 PCB QMX assembly (incl 60-15m version)
1.04a	03-Jun-2024	Corrected problem with 60-15m section 2.5 diagram, page 26