

QMX+ QRP Labs Multimode Xcvr (transceiver) Assembly manual

--- PCB Rev 2 ---

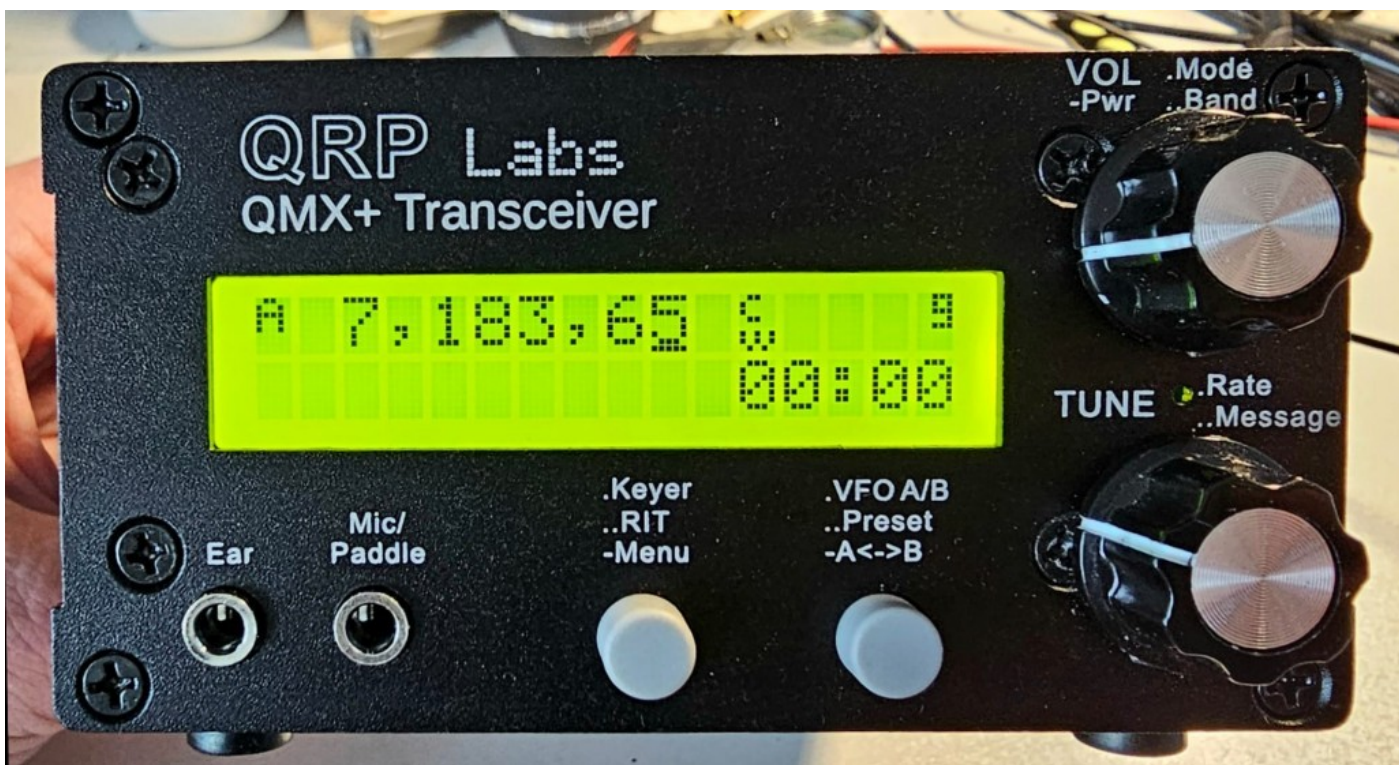

Contents

Contents.....	2
1. Introduction.....	3
2. Assembly.....	5
2.1 General guidelines.....	5
2.2 PCB diagrams (trace, component identification).....	8
2.3 Parts list.....	13
2.4 Inventory of parts.....	19
2.5 Install all the ceramic capacitors.....	21
2.6 Install 1N4007 diodes.....	23
2.7 Install 47uH inductors.....	24
2.8 Install BS170 PA transistors.....	25
2.9 Assemble and install transformer T501.....	26
2.10 Wind and install L502.....	28
2.11 Wind and install Band Pass Filter toroids L401, L403-L405.....	29
2.12 Install Low Pass Filter toroids.....	32
Low pass filters for shiny black T37-10 toroids:.....	33
Low pass filters for yellow T37-6 toroids:.....	34
2.13 Wind and install trifilar toroid T401.....	35
2.14 Wind and install transformer T507.....	38
2.15 Install rear panel connectors.....	39
2.16 Install right-angle front panel pin header connectors.....	40
2.17 Install Audio and Paddle connectors.....	41
2.18 Install R305 contrast trimmer potentiometer.....	43
2.19 Install female pin headers JP301, JP302 and JP304.....	43
2.20 Install CR2032 battery holder.....	44
2.21 Install microphone.....	44
2.22 Install push-button switches S302 and S303.....	45
2.23 Install rotary encoders S301 and S304.....	45
2.24 Assemble front panel and LCD.....	46
2.25 Add the button caps and knobs.....	51
2.26 Final enclosure assembly.....	52
2.28 QMX+ front panel connections.....	54
2.29 QMX+ rear panel connections.....	54
2.30 FINAL CHECKS BEFORE APPLYING POWER THE FIRST TIME!.....	57
2.31 Connections for basic operation.....	58
2.32 Updating the firmware.....	59
3. QLG3 GPS option.....	63
4. Dev kit option.....	65
5. Resources.....	66
6. Document Revision History.....	66

1. Introduction

The QMX+ is a high performance, 12-band 5W multi-mode transceiver with CAT control and built-in USB sound card.

- 160m-6m operation, with 3-5W from a 9V or 12V supply (build options)
- Clean single signal output (zero residual carrier, zero unwanted sideband)
- Large 16 x 2 character yellow/green LCD, switchable backlight
- Built-in SWR metering and protection
- Solid state PIN-diode switched Low Pass Filters and solid state Band Pass Filters
- Solid state transmit/receive switching
- High performance embedded-SDR SSB receiver using 112dB 24-bit stereo ADC chip
- Built-in USB sound card: 48ksps 24-bit stereo
- Built in USB Virtual COM port serial for CAT control
- Si5351A Synthesized local oscillator with better than 0.001Hz resolution and high precision 25MHz TCXO reference as standard
- Built-in signal generator
- Built-in suite of configuration and analysis tools
- Built-in iambic keyer
- On-screen S-meter
- CW decoder
- CW: Full or semi QSK, fast break-in; VFO A/B/Split, RIT, configurable offset, sidetone
- Beacon mode: standalone CW, FSKCW or WSPR operation
- CR2032 battery backed real-time clock (CR2032 is not supplied)
- Optional internal GPS module for setting real-time clock and frequency discipline for WSPR operation
- Lifetime free firmware upgrades with QRP Labs Firmware Update (QFU) bootloader for easy firmware update on any OS with no extra software, or drivers, or programming hardware
- All SMD pre-installed by factory, only through-hole component soldering by the constructor
- Low receive current (switching buck converters) 80mA; Transmit current 1.0 – 1.1A (transmit dependent on power supply; example is approximately for 9V supply, 5W output)
- Connectors: USB-C (audio and serial for CAT), Power, PTT (external amp), audio out, paddle and RF
- Built-in microphone for SSB operation
- Optional smart aluminium extruded enclosure measuring 106 x 55 x 146mm
- Optional dev kit board allows your own experiments and modifications

No test equipment is required to build, align and operate this transceiver. All adjustments can be made using built-in test equipment; or left alone (the transceiver will work well even with no adjustment).

We hope you enjoy building and operating this kit! Please read this manual carefully, and follow the instructions step by step in the recommended order. **Pay attention to ALL the details described in this manual.**

The circuit theory is described in detail in another document and we recommend reading and understanding this section too, to get the maximum enjoyment and education from your new radio.

The operating manual is a separate document and will get you started with QMX+ with CW, or with your WSJT-X or other digi modes software, in minutes.

**PLEASE READ THE BASIC ASSEMBLY AND USE INSTRUCTIONS IN THIS MANUAL VERY CAREFULLY BEFORE APPLYING POWER TO THE BOARD!
IMPORTANT!**

QMX+ can be built for 9V or 12V operation! You need to decide NOW!

A 9V QMX+ produces 3-5 W power output from a supply voltage of 9V or a little over. At 12V, a QMX+ built for 9V could be producing 8 W power output which is likely to cause over-heating and perhaps failure of the BS170 final transistors. Do not power a QMX+ with a higher voltage than you built it for.

Operation of QMX+ at more than 5W power output is NOT RECOMMENDED.

If you wish to operate using a 12 V supply, you may use a two turn secondary winding on the output transformer T501, so a 3:2 ratio instead of the 3:3 turns ratio documented in this manual. Remember this when you come to the assembly step for preparing and installing the output transformer T501. The “primary” is still 3 turns, with a tap half way at 1.5 turns. The secondary (no tap) will now be only two turns.

The chart below shows the measured power output vs supply voltage for the standard 3:3 winding (Red line); at 12 V supply the output power of around 8 W is too high and likely to cause over-heating or failure of the power amplifier transistors. If you wish to use a supply of 12 V the 3:2 winding style is more suitable and will produce 3 – 5 W output for 12V supply. The graph shows 40m but other bands are very similar.

Operation at more than 12V will reduce the protection safety margin available in the event of very long key-downs, hot environment, antenna mismatch, cable faults etc. I don't recommend more than 12V. It isn't worth pushing more just for a fraction of a dB. It is acceptable to use diodes in series on the power line, each one will drop the voltage 0.6V or so. Beware that a 12V nominal battery will potentially be several volts higher when fully charged.

40m power output vs Voltage, transformer windings

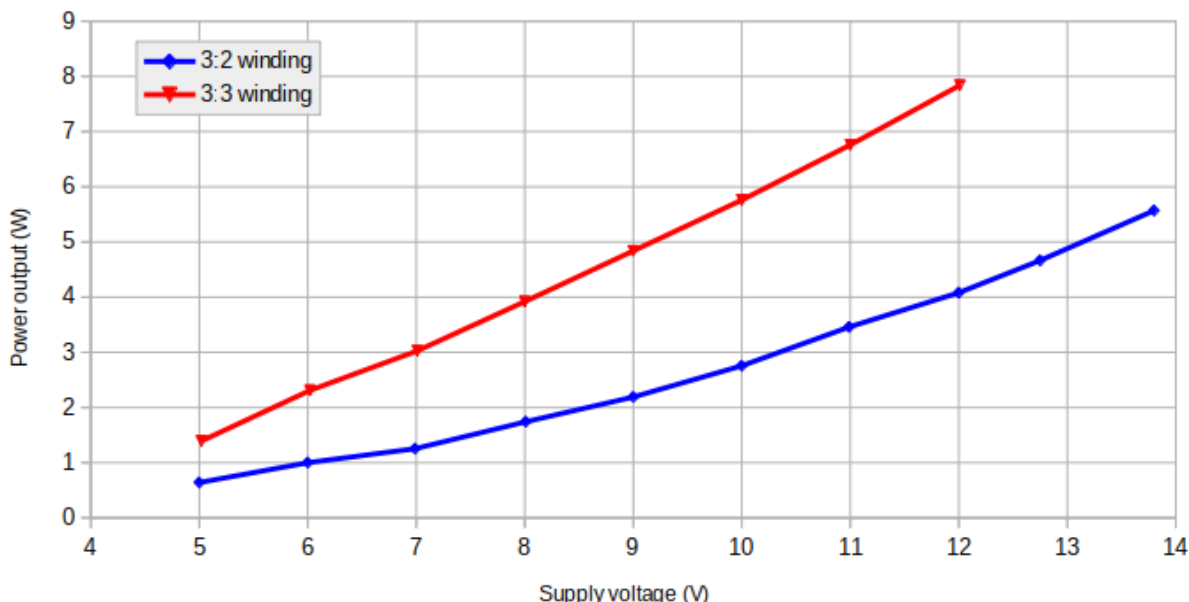

2. Assembly

2.1 General guidelines

Assembly of this kit is quite straightforward, but very detailed; most components are SMD and have already been pre-assembled by the PCB factory. The usual kit-building recommendations apply: work in a well-lit area, with peace and quiet to concentrate. **Some of the other semiconductors in the kit are sensitive to static discharge. Therefore, observe Electrostatic discharge (ESD) precautions.**

And I say it again: **FOLLOW THE INSTRUCTIONS!!**
Don't try to be a hero and do it without instructions!

A jeweler's loupe is really useful for inspecting small components and soldered joints. You'll need a fine-tipped soldering iron too. It is good to get into the habit of inspecting every joint with the magnifying glass or jeweler's loupe (like this one I use), right after soldering. This way you can easily identify any dry joints or solder bridges, before they become a problem later on when you are trying to test the project.



You could also take photos with a mobile phone, and use the phone's zoom features to view the board in detail.

Triple check every component value and location BEFORE soldering the component!

It is easy to put component leads into the wrong holes, so check, check and check again! It is difficult to de-solder and replace components, so it is much better to get them correctly installed the first time. In the event of a mistake, it is always best to detect and correct any errors as early as possible (immediately after soldering the incorrect component). Again, a reminder: removing a component and re-installing it later is often very difficult!

Please refer to the layout diagram and PCB tracks diagrams below, and follow the steps carefully.

Use of a good quality soldering iron and solder is highly recommended for best results!

The following pages show the PCB layout and track diagrams of the QMX+.

When removing the main PCB from its electrostatic-discharge-proof bag, it is a good idea to CUT open the bag rather than try to un-zip it and pull the board out. Cutting it open will make the PCB easier to remove and without risk of damaging protruding components.

6-layer PCB

QMX+ is a 6-layer PCB. This means that there are two internal ground-planes and two internal signal layers, in addition to the normal top and bottom signal layers. This is necessary in order to achieve the required component density in the QMX+ design, as well as to achieve the required ground-plane, signal ground return paths necessary to deliver low-noise and high performance with such a high component density in a mixed mode (analog/digital) board.

Because of the internal layers it is essential that you never ever drill into the PCB; just because you think you see a clear spot on the top and bottom layers, does NOT mean that there is nothing hidden in the middle.

There should never be any reason to drill into the board anyway but I'm just saying, in case for some peculiar reason you feel an irresistible temptation to go wild.

Tracks shown in BLUE are on the bottom layer. Tracks shown in RED are on the top layer. One internal layer is used mainly for transporting digital and analog signals relatively long-distance on the board, and these traces are shown in YELLOW. One layer is used primarily (but not exclusively) for power rails (12V, 5V, 3.3V). These traces are shown in PURPLE. Two of the internal layers are used ONLY for ground-plane with no exceptions. Additionally, all un-used area on ALL the layers, is assigned as ground-plane wherever possible, with frequent ground plane stitching vias connecting the layers on all 6 planes, at intervals not more than 0.1 inches.

For best RF low noise performance, any signal transitioning between layers should have a nearby ground via stitching the ground-planes together, placed as close as possible, to minimize emissions due to discontinuity of the ground return paths. Frequent ground plane stitching also prevents the creation of internal microwave cavities which could resonate and enhance noise propagation between harmonics of digital signals and sensitive RF signals.

This diagram from the Eagle CAD "Design Rules Check" illustrates the layer set-up which is based on the specification of the PCB manufacturer.

Layer	Material	Thickness
1	Copper	0.035mm
	Prepreg	0.185mm
2	Copper	0.035mm
	Core	0.4mm
3	Copper	0.035mm
	Prepreg	0.185mm
14	Copper	0.035mm
	Core	0.4mm
15	Copper	0.035mm
	Prepreg	0.185mm
16	Copper	0.035mm

Type	From	To
Through	1	16

6 layers - + - +
Setup: (1+2*3+14*15+16)
Total Board Thickness: 1.565mm

Apply Select Cancel Check

You will note that there is only one type of via, which goes through the entire board through all 6 layers. In many cases, a signal actually only needs to transition part-way through the board, for example from the bottom layer (16) to the internal signal layer (3). Other types of via are possible, which are called "blind" and "hidden" or "buried" vias.

Blind via: has one end on the board surface layers, and drills through to an internal layer where it terminates. It does not have a drill hole all the way through the board, so other components and traces could be placed on the opposite board surface or on internal layers without conflict.

Hidden or buried via: neither ends of the via are visible on either surface; the via transitions signals entirely between internal layers only.

Unfortunately a 6-layer board is much more expensive than a 2-layer board; and if you use blind or hidden vias the costs escalate even more drastically. For this reason, no blind or buried vias are used in the QMX+. It is necessary to use a 6-layer board, but the design is not so complex or compact that blind or buried vias are needed.

NOTE: the capacitor lead spacing on the PCB is 0.1-inches (2.54 mm) and most of the capacitors are sized appropriately for this. From time to time, due to availability constraints, we may have to use capacitors with 0.2-inch lead spacing (5.08 mm); this is not a mistake, it is just due to component availability. In this case simply use a pair of long-nosed pliers (etc) to straighten out the wires and make them spaced for the 0.1-inch pads.

Board structure

The QMX+ consists of several different PCBs as described below. Some are 6-layer, some only 2-layer (front and back copper traces), as follows:

- **Main board:** (6-layer) the main PCB of the QMX+ with most of the components, on both sides.
- **Front panel board:** (2-layer) the front panel board holds the LCD module, controls (buttons and encoder), audio out and paddle connectors.
- **Connectors board:** (2-layer) This is a small board whose purpose is to hold the two front panel connectors at the correct position behind the front panel.

Additionally there are two optional boards:

- **Dev kit:** (2-layer) this is a plain matrix board with through-hole plated pads, and spacer hardware to mount it 11mm above the main board. There are possible connection points for pin headers between the two boards.
- **QLG3 GPS:** (2-layer) an internal GPS module that fits behind the rear panel. It is powered by QMX+ and permanently connected (unlike an external GPS module at the paddle port).

Tips for a successful build:

1. READ the manual, and every instruction carefully! Don't try to be a hero (proceed without reading carefully). There are many more people who will need to buy a new board, than real heroes...
2. Don't rush! Take your time!
3. Use good lighting!
4. Use a jeweler's loupe to check component values of capacitors BEFORE soldering.
5. Use a soldering iron with a fine tip and high power. For example 60W
6. When soldering capacitors (and other components), note that where pins are grounded, these typically need a lot more heat to ensure a good clean joint. A common error is poorly soldered ground connections of LPF capacitors, which causes incorrect filter performance (often manifested as low power output).
7. When soldering and clipping component leads, be very careful of nearby SMD components which could easily be damaged. Before soldering/clipping, identify nearby SMDs, then make sure that you approach the lead to be soldered or clipped from the opposite direction to the nearby SMD component.
8. KEEP the component lead offcuts from the capacitors – they are used later when installing the LCD module.
9. Solder connectors with no more heat and time necessary to create a good solid clean joint to avoid melting the plastic body parts of the connectors.
10. Remember diodes MUST be connected the correct way round!
11. After every joint, inspect with the jeweler's loupe to check for a good clean joint and any solder bridges to any nearby components: a lot of the components are packed very close together.
12. Clip all components leads as short as possible to avoid any shorts to the enclosure on the underside of the board.
13. Install all connectors square and well-seated on the boards, to ensure when the boards are plugged together and installed in the enclosure, everything fits properly.
14. **QMX+ is supplied with factory-installed firmware. Since some time may have elapsed between when the boards were tested / flashed and when your order was shipped, there may be a later firmware version available now. We recommend you install the latest firmware, a very simple procedure which is described in section 2.33.**

2.2 PCB diagrams (trace, component identification)

Subsequent pages show the trace and component identification diagrams for the various QMX+ PCBs. Ground planes are NOT shown; ground planes occupy EVERY available space on all six layers, with frequent stitching vias between the planes; for the sake of clarity, the vias are also omitted from the diagrams.

QMX+ Main board:

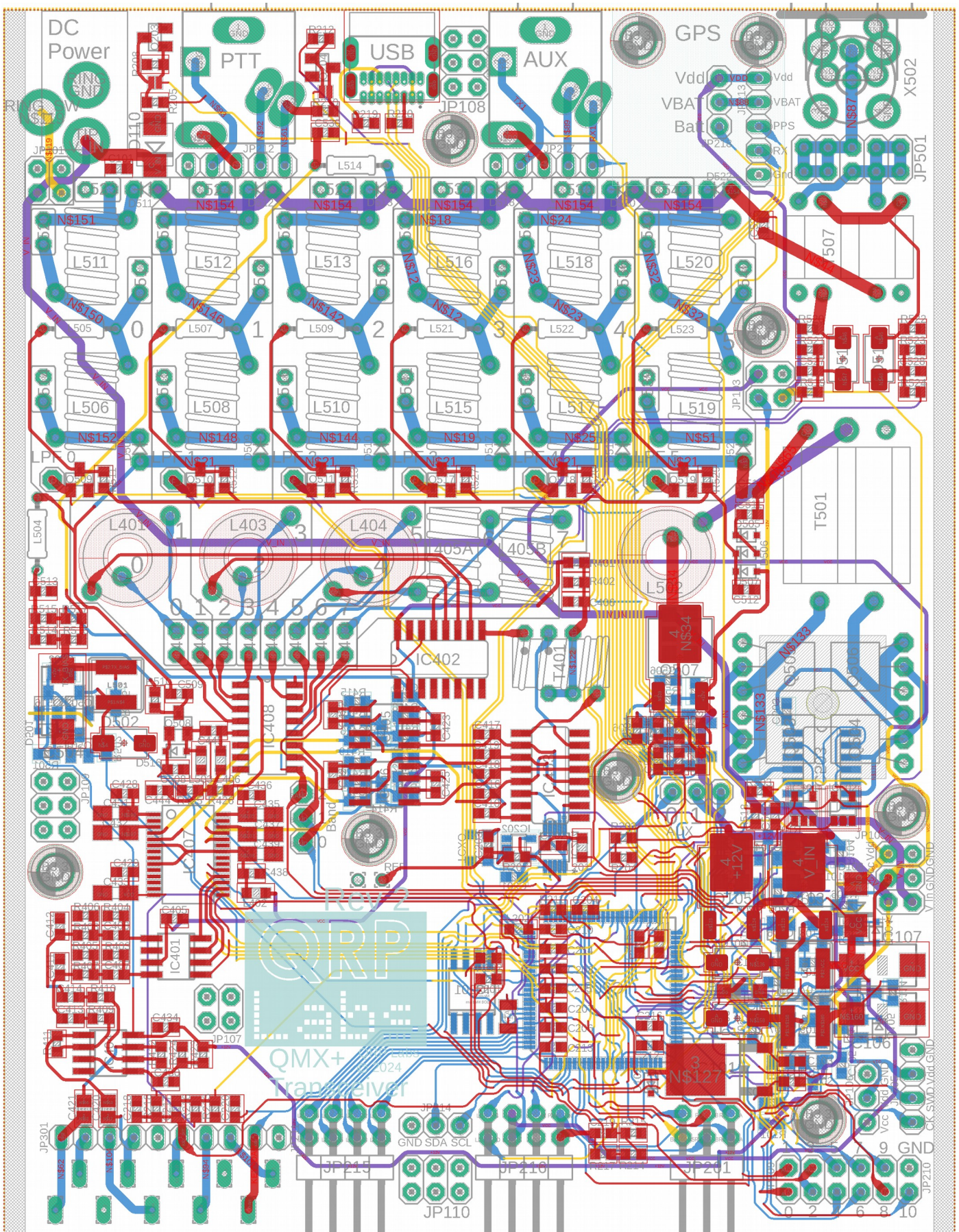

QMX+ Main board layout, top side:

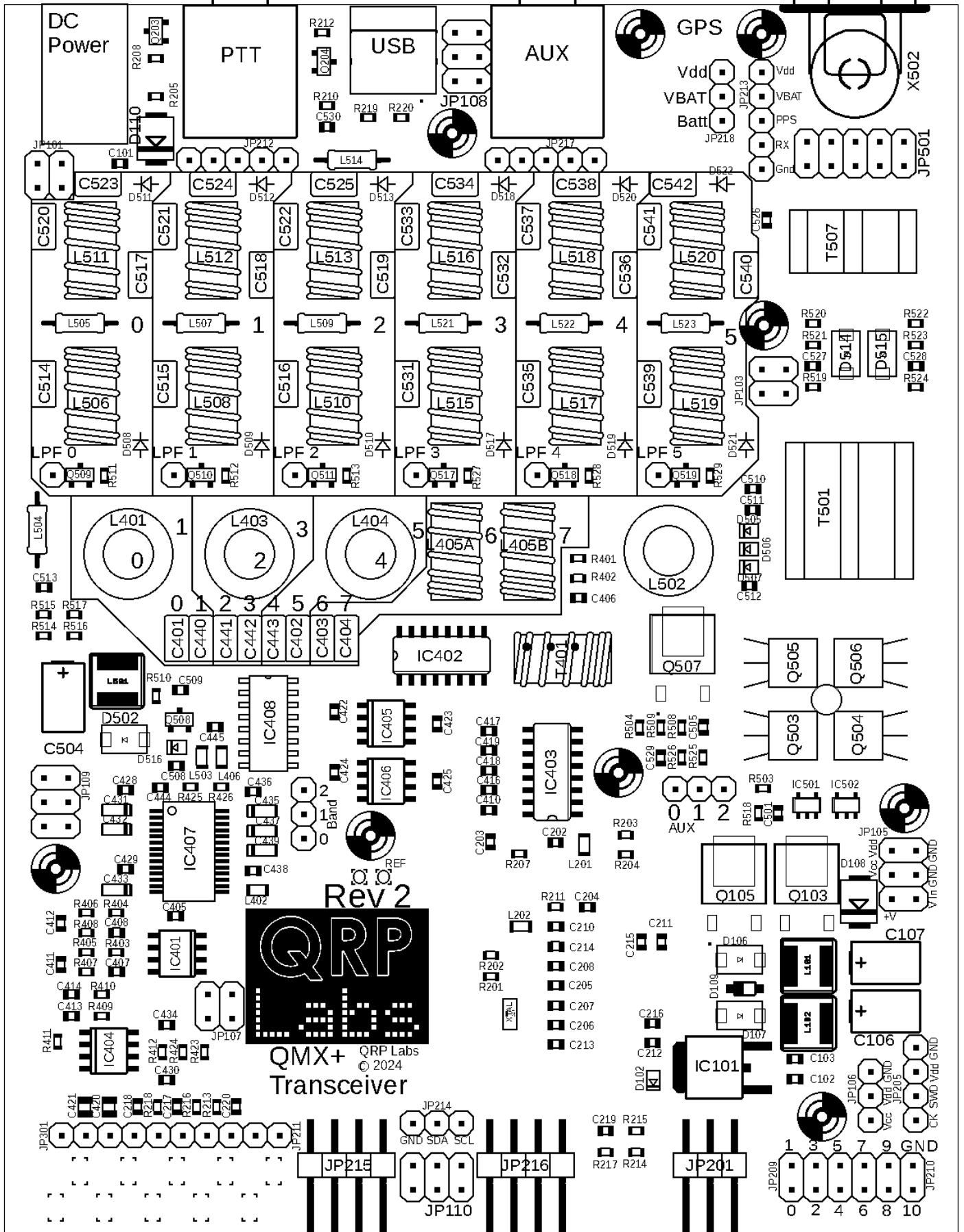

QMX+ Main board layout, bottom side:

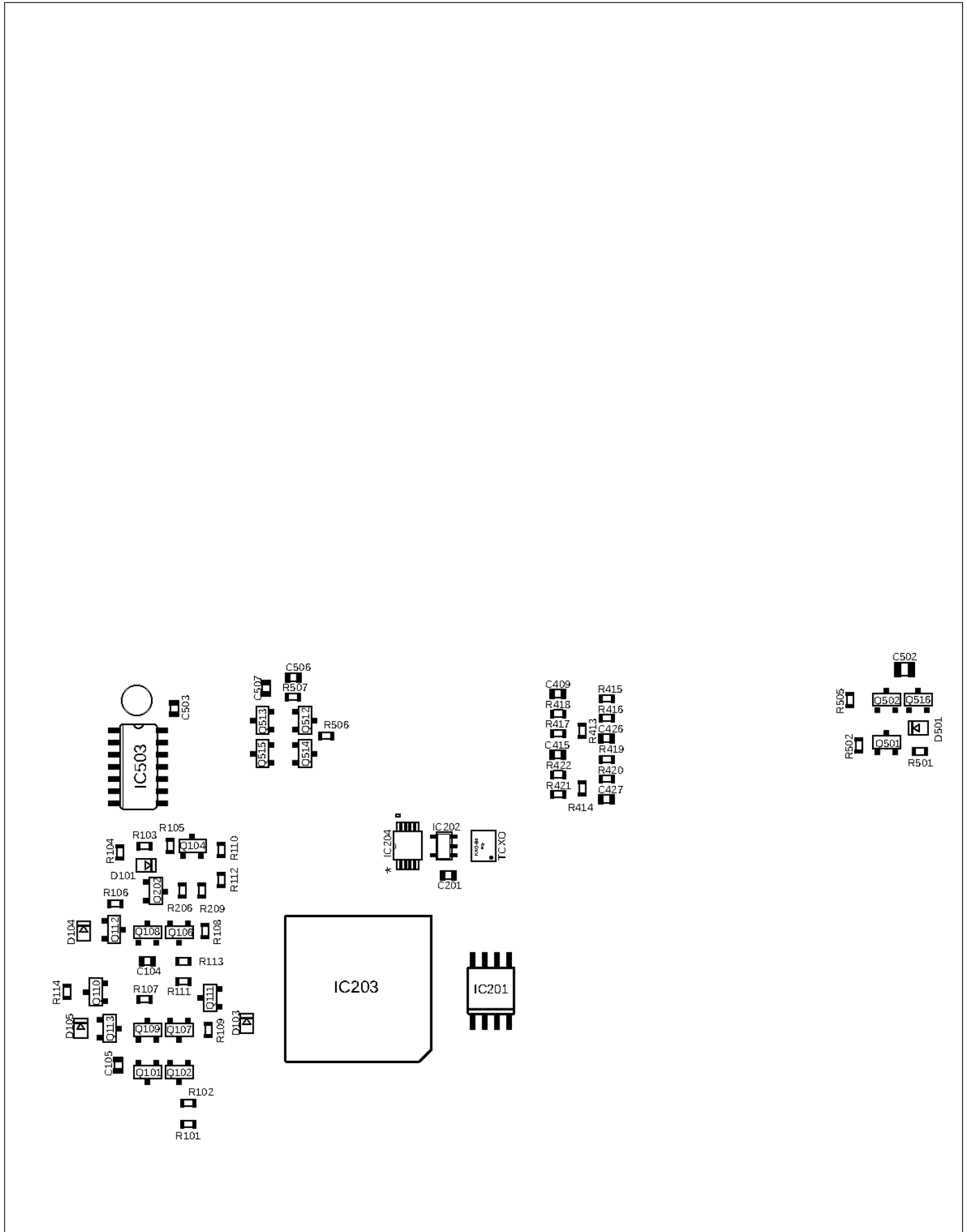

QMX+ Front panel board traces:

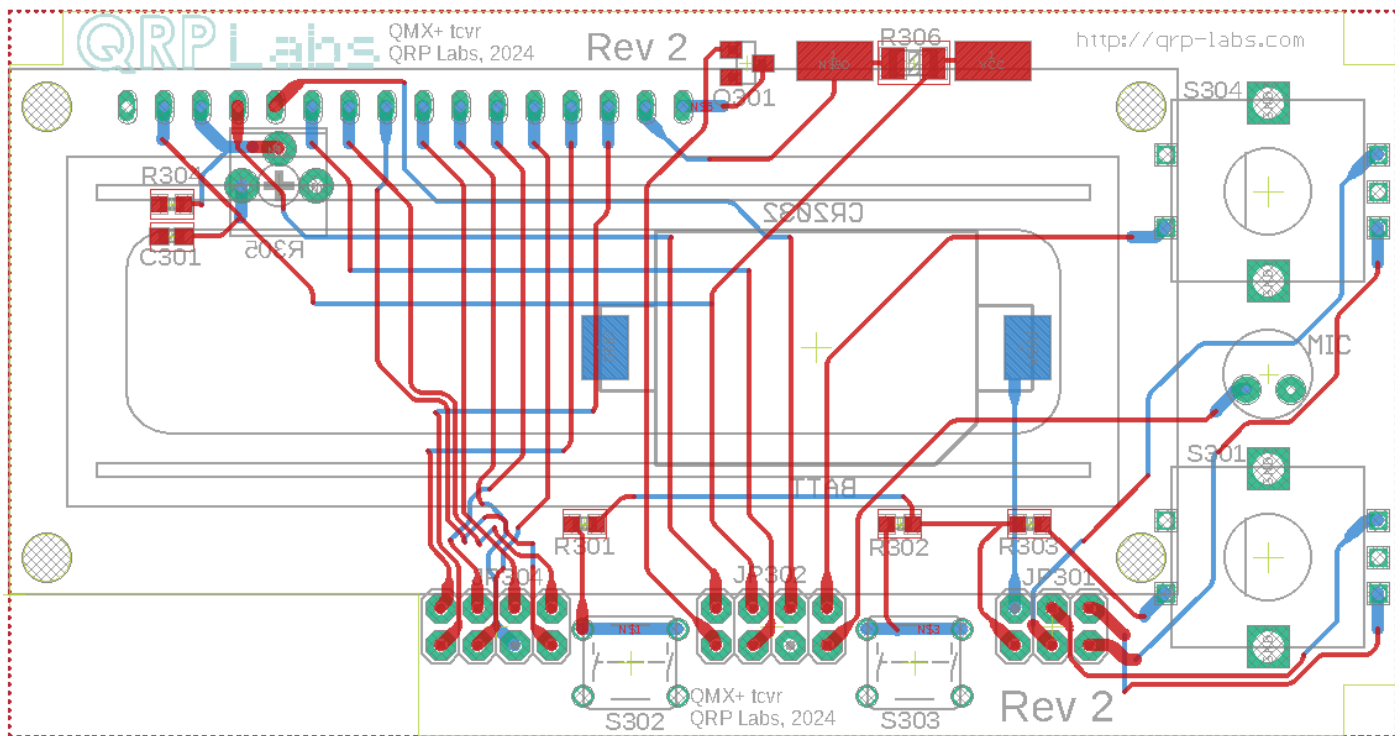

QMX+ Front panel board:

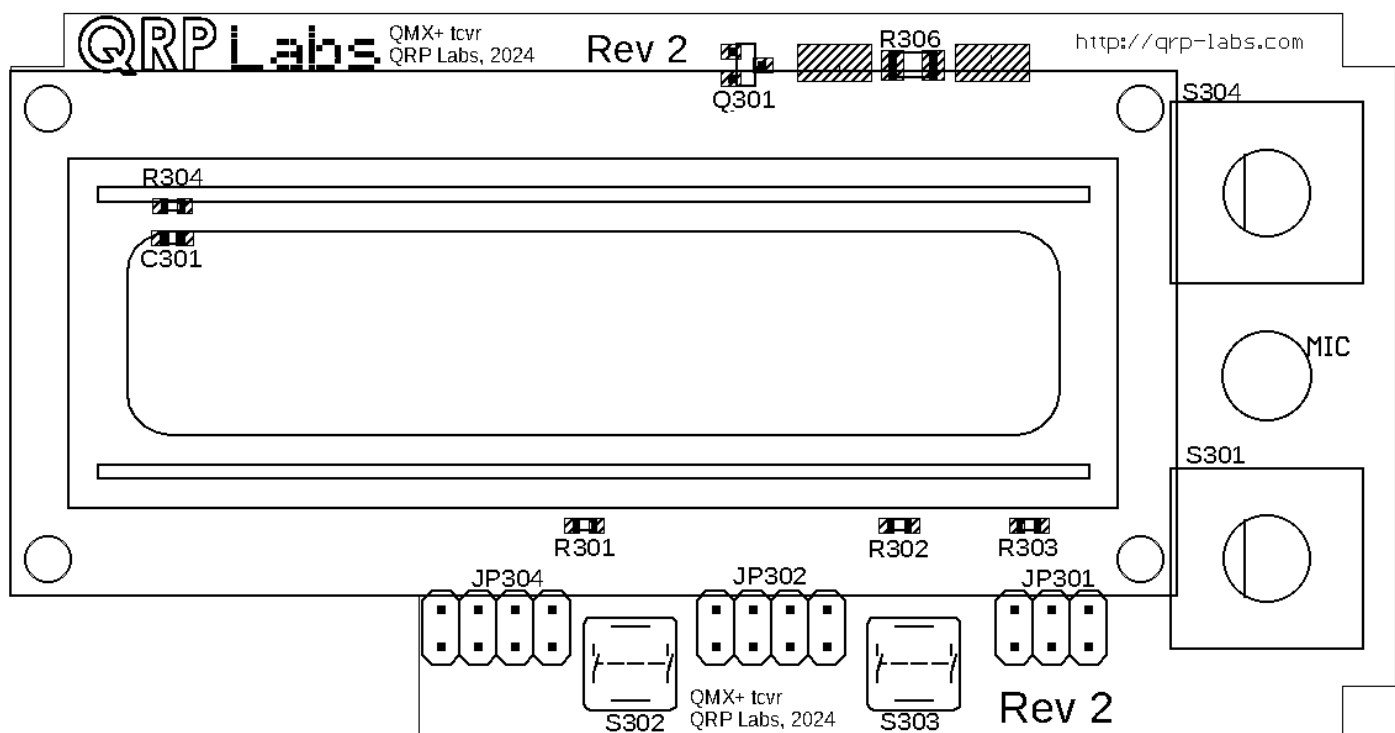

QMX+ Connectors board:

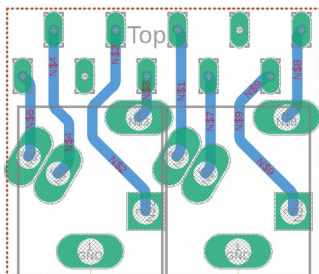

2.3 Parts list

Component nomenclature is by schematic sheet. Part numbers

- 1xx Power supplies, schematic page 1
- 2xx Main board, CPU etc., schematic page 2
- 3xx LCD board and controls board, schematic page 3
- 4xx Main board, receiver section, schematic page 4
- 5xx Main board, transmitter section, schematic page 5

Many components are SMD, pre-soldered to the PCB in the factory. Only through-hole components need to be installed by the constructor. SMD components in the parts list are identified in the Description column and by the text colour being purple.

Resistors

Qty	Value	Description	Component numbers
14	100k	SMD 0603	R101, R103, R104, R105, R108, R109, R208, R209, R212, R502, R503, R518, R521, R523
20	10K	SMD 0603	R102, R106, R107, R204, R213, R214, R215, R216, R401, R402, R405, R406, R425, R426, R501, R505, R508, R519, R524, R526
7	22k	SMD 0603	R110, R111, R112, R113, R206, R423, R424
5	47-ohms	SMD 0603	R114, R415, R418, R419, R422
4	1k	SMD 0603	R201, R202, R515, R517
2	47k	SMD 0603	R203, R525
2	220-ohms	SMD 0603	R205, R210
5	470k	SMD 0603	R207, R510, R511, R512, R513, R527, R528, R529
3	2.2k	SMD 0603	R211, R217, R218
4	3.3k	SMD 0603	R301, R304, R409, R410
1	6.8k	SMD 0603	R302
1	13k	SMD 0603	R303
1	33-ohms	SMD 1206	R306
2	267k	SMD 0603	R403, R404

Qty	Value	Description	Component numbers
2	560-ohms	SMD 0603	R407, R408
3	5.6k	SMD 0603	R411, R412, R507
2	100-ohms	SMD 0603	R413, R414
4	470-ohms	SMD 0603	R416, R417, R420, R421
4	5.1k	SMD 0603	R504, R506, R519, R520
1	1.91k	SMD 0603	R509
2	33-ohms	SMD 0603	R514, R516
2	49.9-ohms	SMD 0603	R520, R522
1	20K	TRIM3339P Trimmer	R305

Capacitors (50V, Multi-layer Ceramic capacitors except where indicated otherwise)

Qty	Value	Description	Component numbers
16	2.2u	SMD 0603	C101, C102, C103, C104, C105, C215, C216, C406, C407, C408, C413, C414, C430, C434, C444, C510
3	470u	10V tantalum	C106, C107, C504
31	0.1u	SMD 0603	C201, C202, C203, C206, C207, C208, C209, C210, C211, C212, C214, C217, C219, C409, C410, C415, C428, C429, C436, C438, C445, C501, C503, C507, C508, C513, C526, C527, C528, C529, C530
3	47n	SMD 0603	C205, C411, C412
3	1u	SMD 0603	C213, C405, C506
5	1n	SMD 0603	C204, C218, C220, C505, C509
4	33n	SMD 0603	C416, C417, C418, C419
3	10u	SMD 0805	C420, C421, C502
4	4.7n	SMD 0603	C422, C423, C424, C425
2	10n	SMD 0603	C426, C427
4	10u	Tantalum case A style	C431, C433, C435, C439
2	1u	Tantalum case A style	C432, C437
2	47p	SMD 0603	C511, C512
1	10p	Label "100" or "10J"	C541
2	15p	Label "150" or "15J"	C404, C537
1	27p	Label "270" or "27J"	C533
1	30p	Label "300" or "30J"	C403
1	33p	Label "330" or "33J"	C402
1	39p	Label "390" or "39J"	C443
1	43p	Label "430" or "43J"	C522
3	68p	Label "680" or "68J"	C442, C539, C54
1	82p	Label "820" or "82J"	C538
1	100p	Label "101"	C521
3	120p	Label "121"	C441, C535, C540

Qty	Value	Description	Component numbers
3	180p	Label "181"	C531, C534, C536
1	220p	Label "221"	C520
1	270p	Label "271"	C440
1	330p	Label "331"	C532
2	390p	Label "391"	C516
4	680p	Label "681"	C515
1	820p	Label "821"	C523
2	1200p	Label "122"	C514
1	2200p	Label "222"	C517

Semiconductors

Qty	Description	Component numbers
10	SMD: 1N4148 SOD323	D101, D102, D103, D104, D105, D501, D505, D506, D507, D516
5	SMD: SS14 DO-214AC	D106, D107, D502, D514, D515
12	1N4007 diode	D508, D509, D510, D511, D512, D513, D517, D518, D519, D520, D521
1	SMD: 5.6V 5W SMB	D108
1	SMD: 3.6V 500mW SOD-123	D109
1	SMD: 78M33 TO252	IC101
1	SMD: 24M01 SOIC-8	IC201
1	SMD: SN74AHC1G00DBV	IC202
1	SMD: STM32F446VET6	IC203
1	SMD: MS5351M	IC204
1	SMD: CS4334 SOIC-8	IC401
2	SMD: 74CBT3253 SOIC-16	IC402, IC403
1	SMD: NE5532 SOIC-8	IC404
2	SMD: LT6231	IC405, IC406
1	SMD: PCM1804	IC407
1	SMD: 74CBT3251	IC408
2	SMD: 74AHC1G86DBV	IC501, IC502
1	SMD: 74ACT08 SOIC-14	IC503
1	SMD: BSS84AK MOSFET	Q202 (Nexperia brand)
3	SMD: BSS84 MOSFET	Q102, Q204, Q502
15	SMD: BSS123 MOSFET	Q101, Q104, Q106, Q107, Q110, Q203, Q301, Q501, Q508, Q509, Q510, Q511, Q517, Q518, Q519
5	SMD: BC817 NPN SOT23-3	Q112, Q113, Q512, Q514, Q516
2	SMD: BC857 PNP SOT23-3	Q513, Q515
4	BS170: TO92 MOSFET	Q503, Q504, Q505, Q506

Qty	Description	Component numbers
3	SMD: AO3415A SOT23-3	Q108, Q109, Q111
3	SMD: AOD403 (TO252)	Q103, Q105, Q507
1	SMD: 25MHz TCXO module	TCXO
1	SMD: 32,768kHz crystal	XTAL

Inductors

Qty	Description	Component numbers
5	SMD: 47uH L2012	L201, L202, L402, L406, L503
3	SMD: 330uH (CD54)	L101, L102, L501
8	47uH axial inductor	L504, L505, L507, L509, L514, L521, L522, L523
2	FT37-43 (dull matt black)	L502, T401
1	BN61-202 binocular, 3:3	T501
1	BN43-1502 binocular	T507
1	T50-2 (red)	L401
1	T37-6 (yellow)	L506
4	T37-6 (yellow) OR T37-10 (black)	L403, L508, L511, L512
4	T37-17 (yellow/blue)	L404, L405b, L510, L513
7	T37-0 (pink)	L405a, L515, L516, L517, L518, L519, L520

Miscellaneous

Qty	Value	Description
1	2.1 mm DC	2.1 x 5.5 barrel DC power connector
1	USB C	USB type C connector
1	BNC	Metal RF connector
4	3.5mm jack	3.5mm Stereo connector
1	CR2032 socket	CR2032 coin cell holder
2	2x4	Pin header connector socket (female)
2	2x4	Pin header connector 90-degree plug (male)
1	2x3	Pin header connector socket (female)
1	2x3	Pin header connector 90-degree plug (male)
1	1x16	Pin header connector plug (male)
1	PCB	Main PCB Assembly
1	PCB	Front panel PCB Assembly
1	PCB	Connectors PCB
1	1602 LCD	80x36mm HD44780 LCD module yellow/green
1	6mm Electret	Microphone
2	Rotary	Rotary encoder switch
2	6x6x12mm	Push-button switch

Qty	Value	Description
2	Switch cap	Cap for push-button switch
2	15mm	Knob
1	880cm	0.33 mm diameter wire (AWG #28)
1	M3 x 10 mm	Steel 10mm long M3 screw
1	M3	Steel M3 nut
1	M3 x 12 mm	Steel 12mm diameter M3 washer
4	M3 x 6mm	Nylon threaded hex spacer, 6mm
4	M3 x 20mm	Black machine screw
8	M3	Nylon nut

Enclosure (OPTIONAL)

Qty	Value	Description
2	Top/Bottom	Extruded aluminium top/bottom (identical parts)
1	Front panel	Laser etched drilled/cut (display, controls, connectors)
1	Rear panel	Laser etched, drilled (connectors)
8	M3 machine screw	Screws to secure end panels
4	Rubber foot	Self-adhesive rubber foot

QLG3 GPS (OPTIONAL)

Qty	Value	Description
1	PCB Assembly	QLG3 GPS PCB Assembly
1	Antenna	1575MHz active patch antenna, 2m cable and SMA
1	SMA connector	90-degree SMA connector
2	M3 x 11mm	Nylon threaded hex spacer, 11mm
4	M3 x 6mm	Nylon screw
1	1x5	Pin header connector socket (female)
1	1x5	Pin header connector plug (male)

Dev kit (OPTIONAL)

Qty	Value	Description
1	PCB	Dev kit PCB
4	M3 x 11mm	Nylon threaded hex spacer, 11mm
8	M3 x 6mm	Nylon screw

Real time clock (optional CR2032 battery installation)

QMX+ contains a real time clock backed up by a CR2032 coin cell battery so that the clock keeps running on its own when the rest of the QMX+ is powered down or the power source is disconnected.

For safety reasons we are not able to ship the CR2032 coin cell battery internationally so it is not included. However this is an extremely common battery type which is easily available and very inexpensive. So you can procure and fit the battery yourself. As is normal for this type of battery, the battery needs to be inserted into the socket so that the + is on the outside.



IMPORTANT NOTES!

- 1) Please power down QMX+ before inserting the battery!
- 2) Try to handle the actual cell as little as possible, I heard rumors that greasy fingers can leave oil on the battery which depletes it faster.
- 3) Apparently not all CR2032 batteries are exactly the same physically so you may find it doesn't fit as easily as mine did; check carefully that both contacts are contacting the correct poles of the battery and are not short-circuiting the battery.

2.4 Inventory of parts

Note: Capacitor and toroid colours vary depending on availability. All capacitors are NP0/COG Class-I RF dielectric.

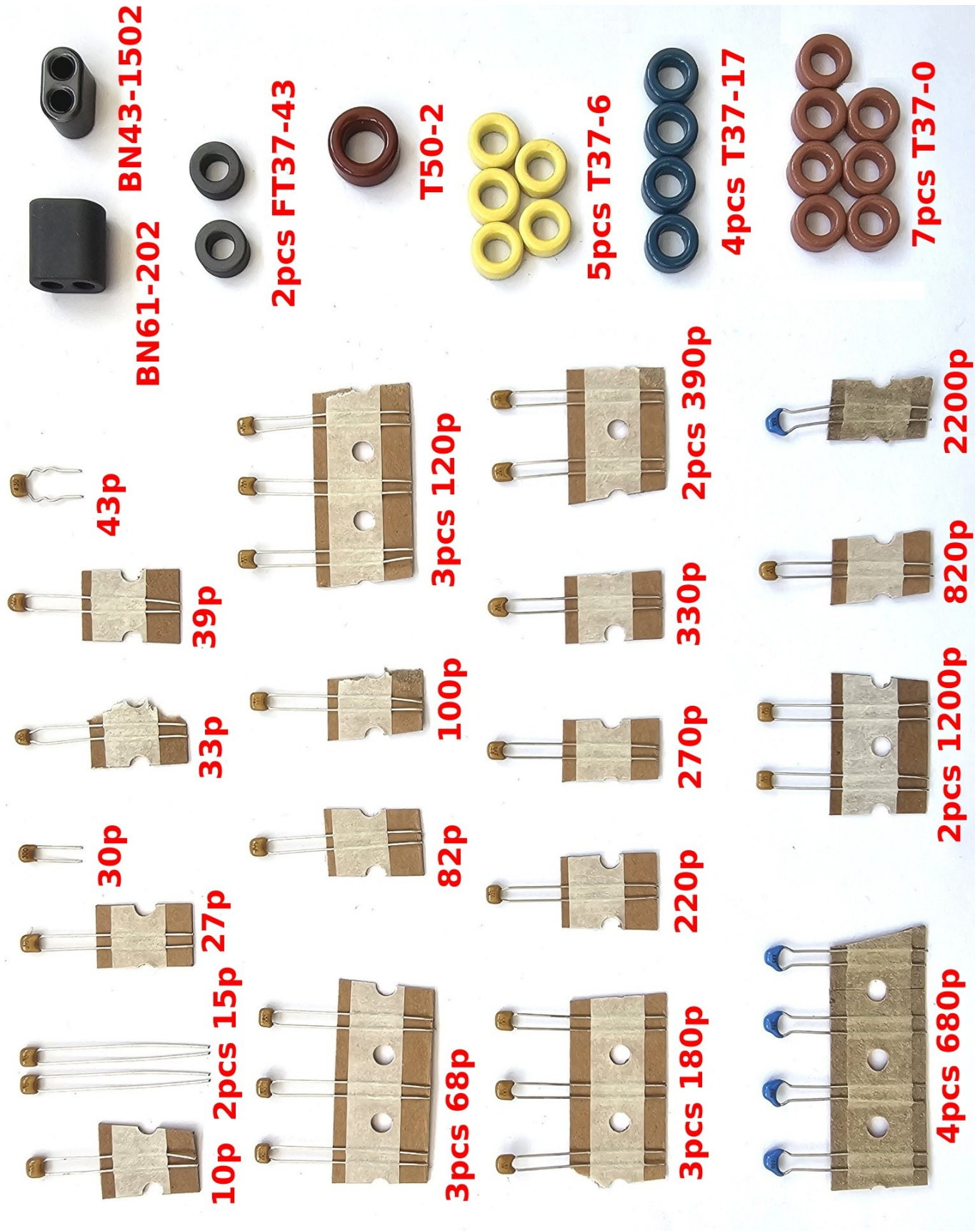



8pcs 47uH inductor



12pcs 1N4007 diode



4pcs BS170



8pcs M3 nut (nylon)

6mm microphone



2.1mm connector



4pcs 3.5mm stereo jack socket



2x3 90deg male header



2x3 female socket



2pcs 2x4 90deg male



2pcs 2x4 female



4pcs 6mm hex spacer



4pcs 20mm screw



CR2032 coin battery holder



1x16-pin male header



10mm screw



12mm washer

M3 nut



2pcs 15mm knob



2pcs 6x6x12mm switch



2pcs rotary encoder



2pcs Button cap



22K trimmer



BNC connector

2.5 Install all the ceramic capacitors

There are 32 through-hole capacitors in accordance with the following table and diagram. The procedure is so easy that I have included all capacitors in a single assembly step rather than doing one diagram for each capacitor value. Nevertheless be very careful to insert the correct value capacitors in the correct places. Mistakes are VERY hard to correct later, and WILL ruin some aspect of the radio's functioning! So check and double-check before soldering!

In the diagram, the component label (capacitor body inscription) is written in red next to the capacitor body. The diagram shows the rear part of the PCB, rotated 90-degrees with the rear panel connectors on the right hand side.

- The usual labeling for capacitors is three numbers where the first two digits indicate the value, and the third indicates the number of zeroes. For example "122" means 12 followed by 2 zeroes, which is 1200pF. However for capacitors smaller than 100pF, they are often (but not always) labeled with just two digits followed by a letter indicating the tolerance. **Again – be very careful to correctly identify the capacitors before installation.**
- Capacitor colours may differ from those shown in the inventory photograph; two brands of NP0 capacitors are used according to availability, either the yellow-coloured Vishay (preferably), or blue-coloured TDK brand.
- The 43pF capacitor was only available with 5mm spaced leads so you need to bend them carefully to fit in the 2.5mm-spaced holes.
- **Keep the wire off-cuts! We need them later!**
- **Ground pin connections require a LOT more heat to achieve a good joint.**

Qty	Value	Description	Component numbers
1	10pF	Through-hole, label "100" or "10J"	C541
2	15pF	Through-hole, label "150" or "15J"	C404, C537
1	27pF	Through-hole, label "270" or "27J"	C533
1	30pF	Through-hole, label "300" or "30J"	C403
1	33pF	Through-hole, label "330" or "33J"	C402
1	39pF	Through-hole, label "390" or "39J"	C443
1	43pF	Through-hole, label "430" or "43J"	C522
3	68pF	Through-hole, label "680" or "68J"	C442, C539, C542
1	82pF	Through-hole, label "820" or "82J"	C538
1	100pF	Through-hole, label "101"	C521
3	120pF	Through-hole, label "121"	C441, C535, C540
3	180pF	Through-hole, label "181"	C531, C534, C536
1	220pF	Through-hole, label "221"	C520
1	270pF	Through-hole, label "271"	C440
1	330pF	Through-hole, label "331"	C532
2	390pF	Through-hole, label "391"	C516, C525
4	680pF	Through-hole, label "681"	C401, C515, C519, C524
1	820pF	Through-hole, label "821"	C523
2	1200pF	Through-hole, label "122"	C514, C518
1	2200pF	Through-hole, label "222"	C517

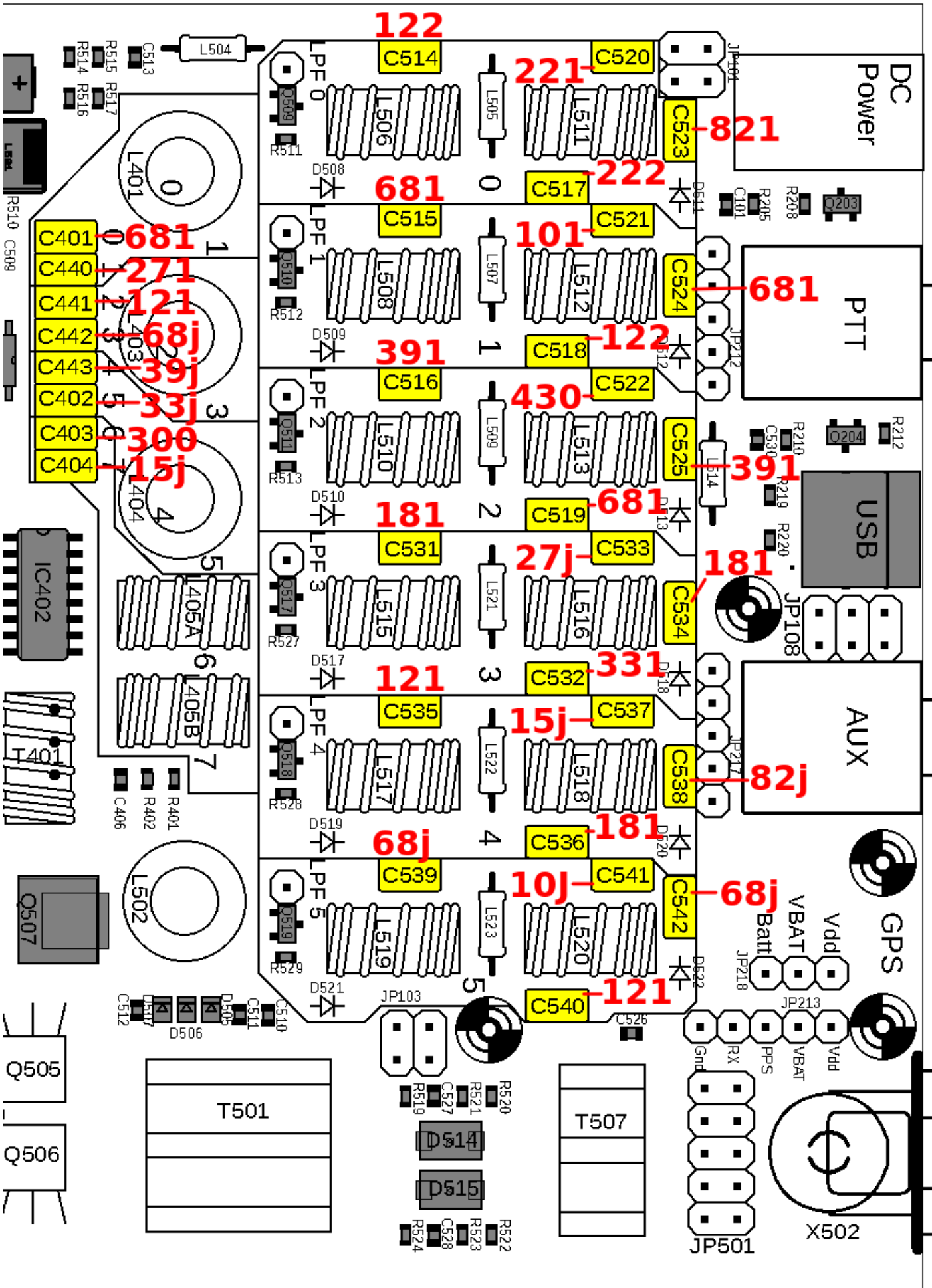

2.6 Install 1N4007 diodes

Install the 12 1N4007 diodes D508-D513 and D517-522.

Pay attention to the orientation of the diodes which is critically important. The diodes have a black body and a white stripe. The PCB silkscreen arrows point towards the white stripe (diode cathode) end. But the white silkscreen arrow on the PCB can be hard to see.

The QMX+ PCB has a regular repetitive layout, which makes it much easier to install these diodes than on a QMX:

- All six diodes at the LPF outputs, nearest the top edge of the PCB in the diagram (rear panel side) are orientated with their cathodes (white stripe) pointing to the LEFT.
- All six diodes at the LPF inputs are orientated with their cathodes (white stripe) pointing UP.

One lead of the diode needs to be bent over. It doesn't matter which one, all that's important is that the cathode (white stripe) is correctly soldered to the pad at pointed to by the arrow. I chose to bend the diode lead with the cathode.

Again this diagram shows only the rear half of the QMX+ PCB.

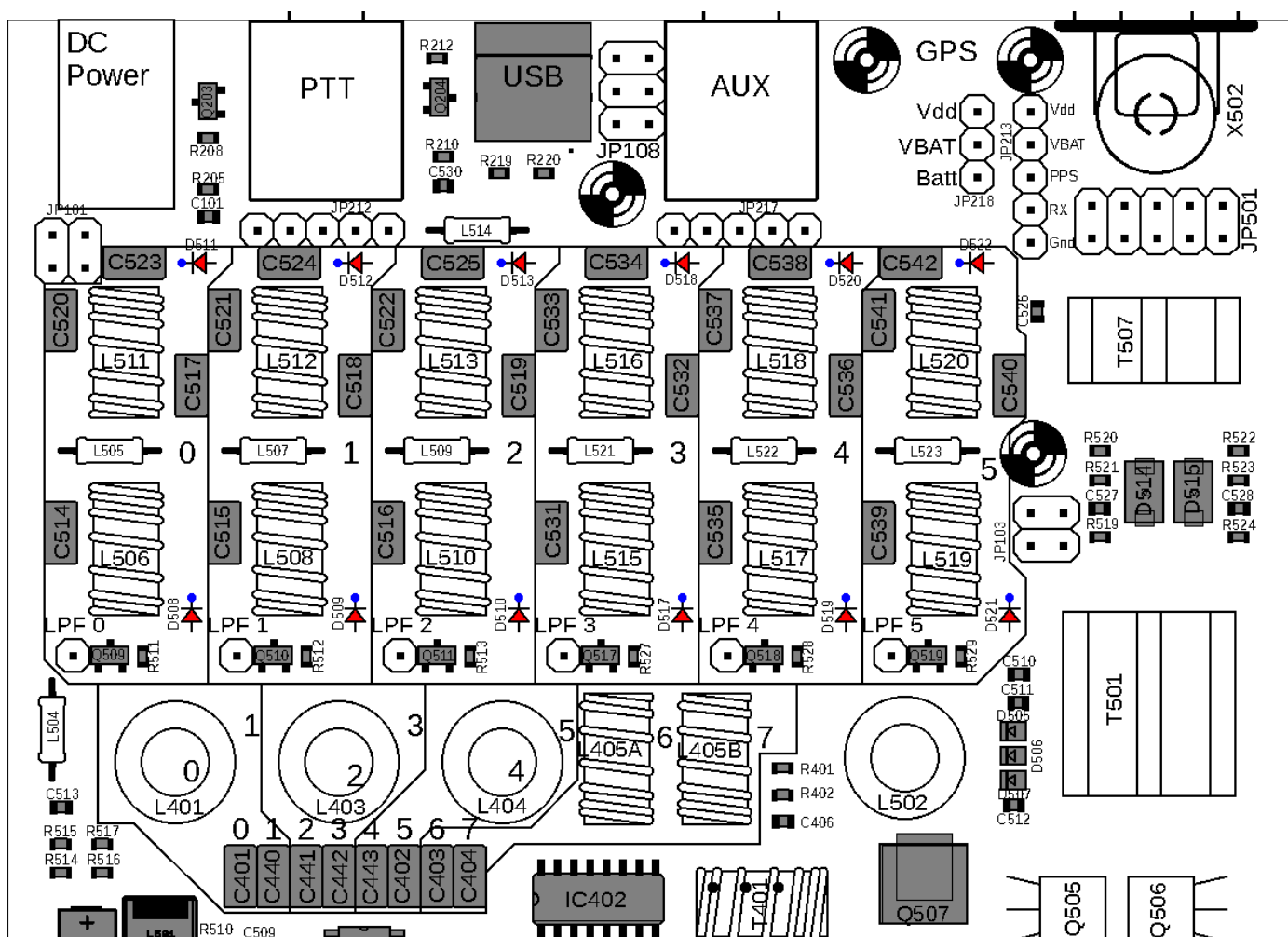

2.7 Install 47uH inductors

Install the eight 47uH axial inductors L504, L505, L507, L509, L514, L521, L522 and L523.. These axial through-hole inductors are all installed lying flat on the PCB. Bend each lead at 90-degrees carefully, near the inductor body, and the wires should then be correctly spaced to fit the holes on the board.

The orientation of these inductors is not important. The diagram shows the rear half of the main PCB.

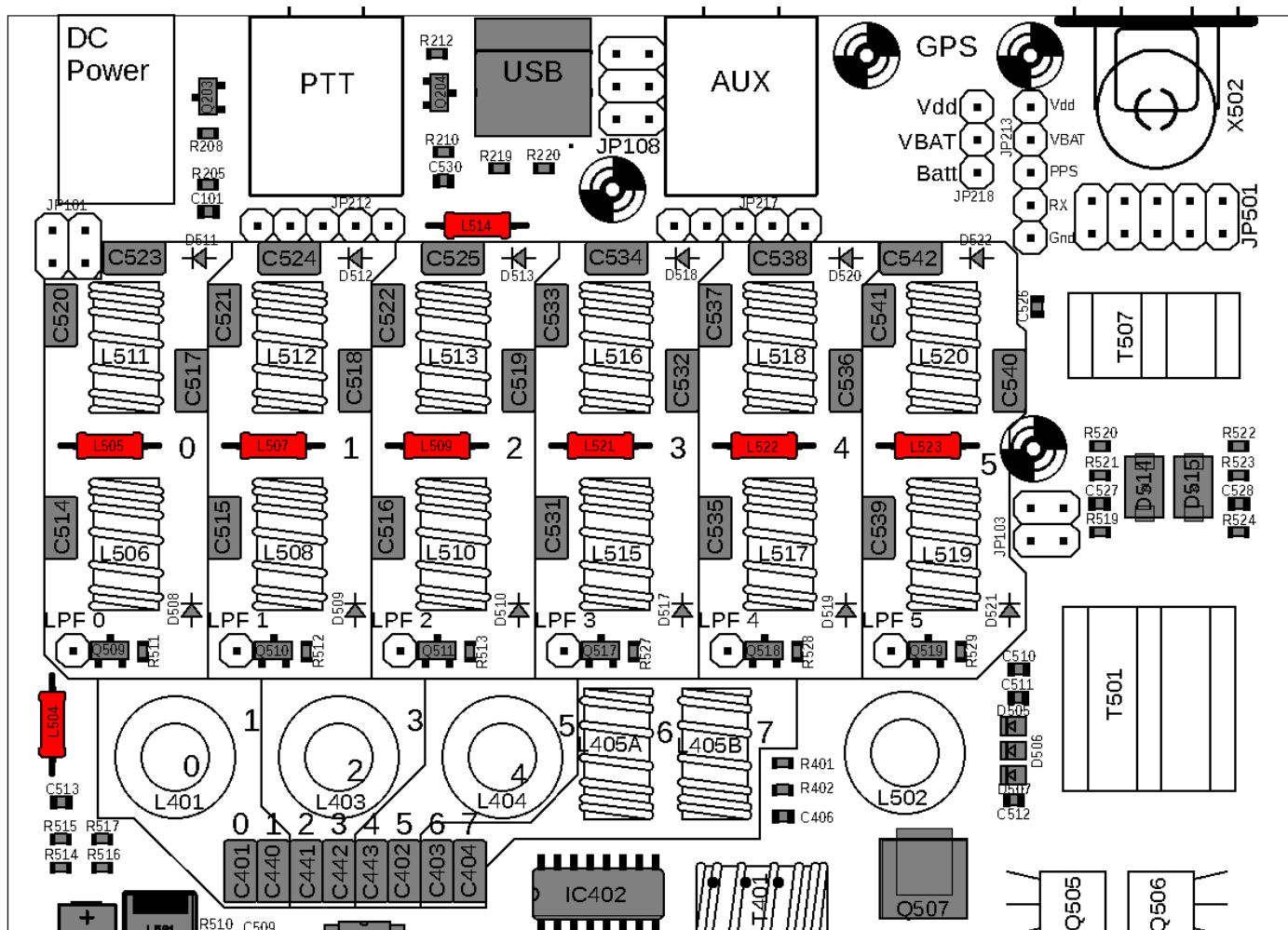

2.8 Install BS170 PA transistors

Install the four BS170 transistors in the positions shown, with their flat faces flush against the PCB.

Use the 10mm M3 steel bolt, washer and nut to firmly press the transistor faces against the PCB, as shown.

Refer to the diagram and photographs below.

Note that the washer is NOT the heatsink. Its purpose is to hold the transistor flats against the PCB, which is intended to be the heatsink.

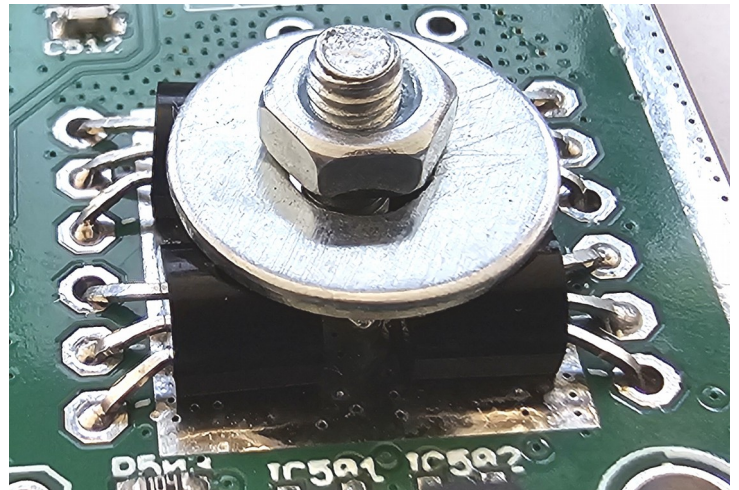
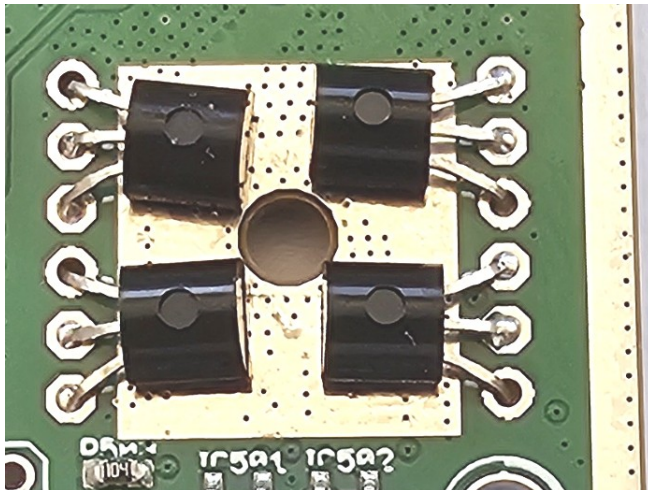
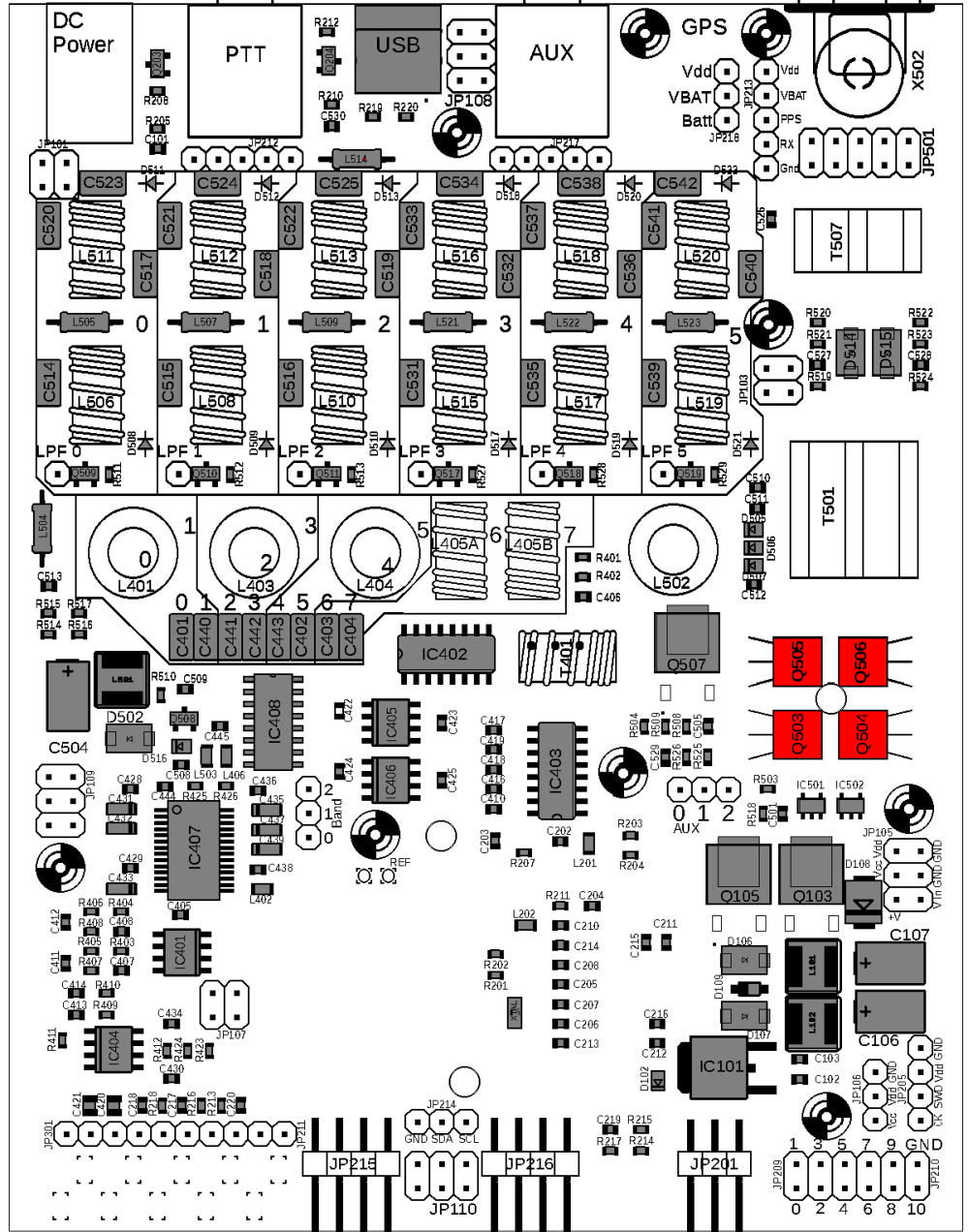

2.9 Assemble and install transformer T501

Transformer T501 is wound on the large binocular ferrite former, using 0.33mm (AWG #28) wire.

This wire is also used for L502 and T507 so do not use all of it on the transformer. Please refer to the separate document that describes the preparation of this transformer.

When the transformer is ready, insert the wires into the holes on the PCB.

Note: Previously 0.60mm wire was used, now the kit is supplied with 0.33mm. 0.33mm wire was found to have equivalent (or even slightly better) performance than 0.60mm.

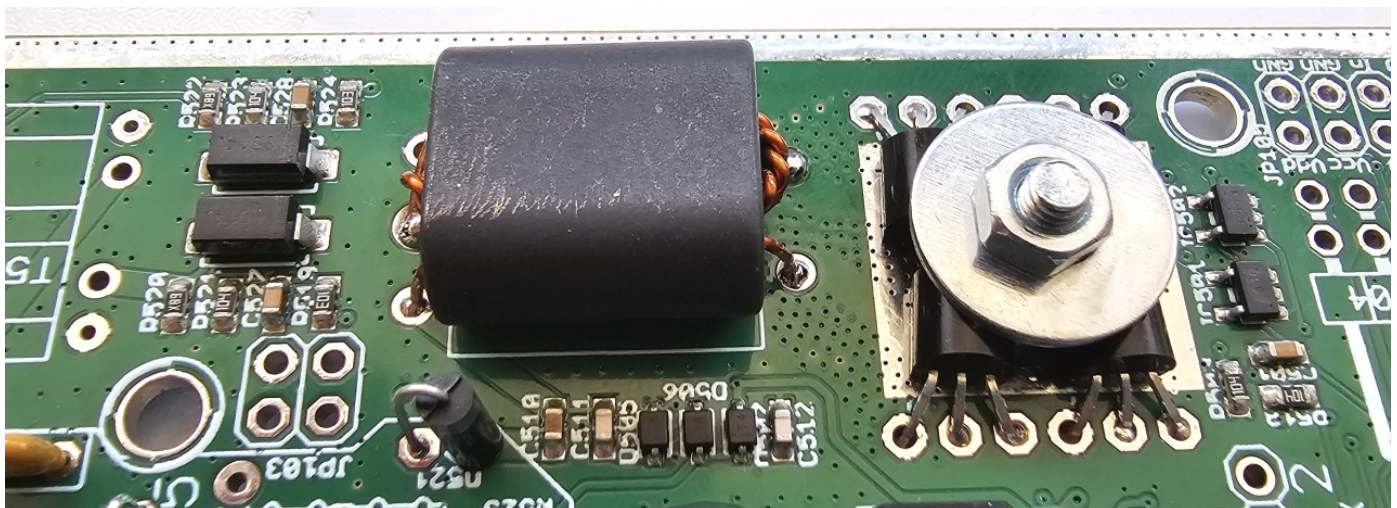
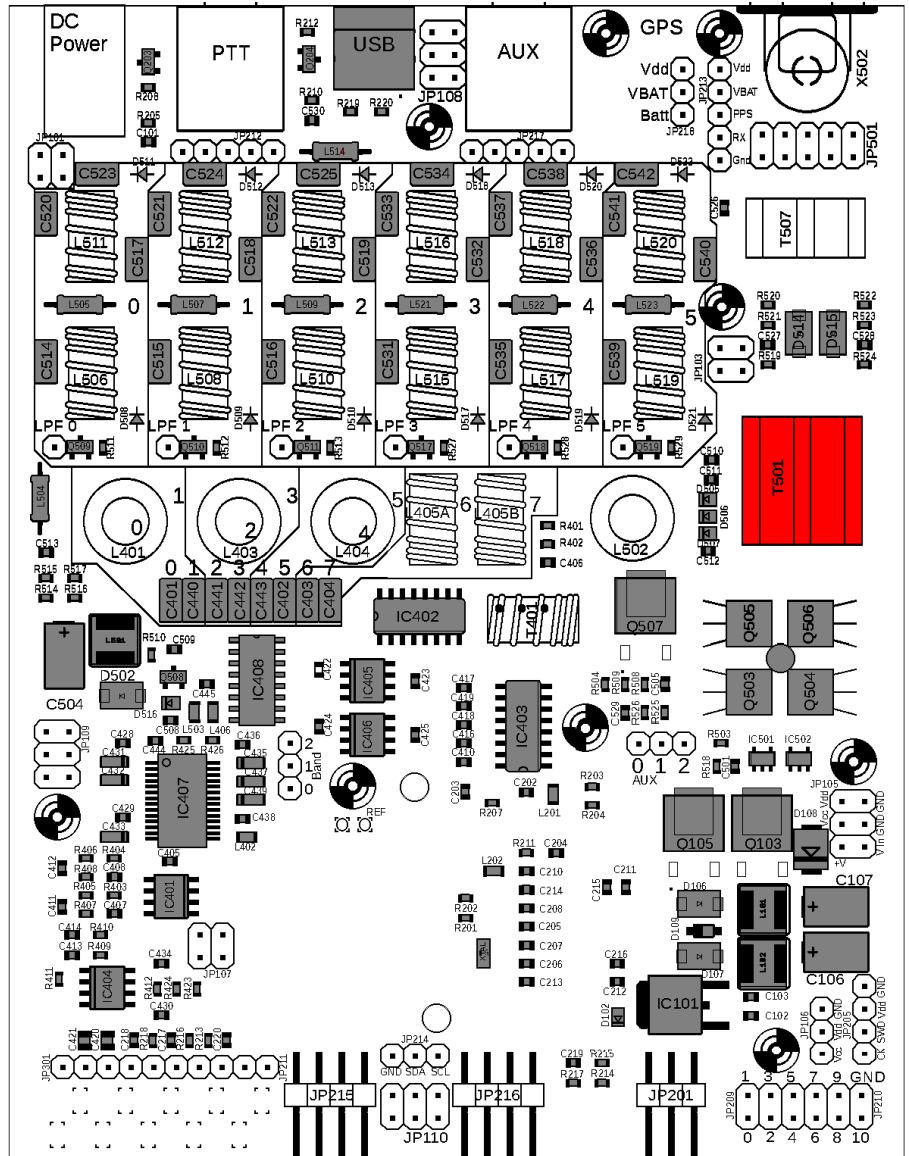

Cut the wire-endings to a length of about 2mm on the underside of the board and solder them with plenty of heat, time and solder.

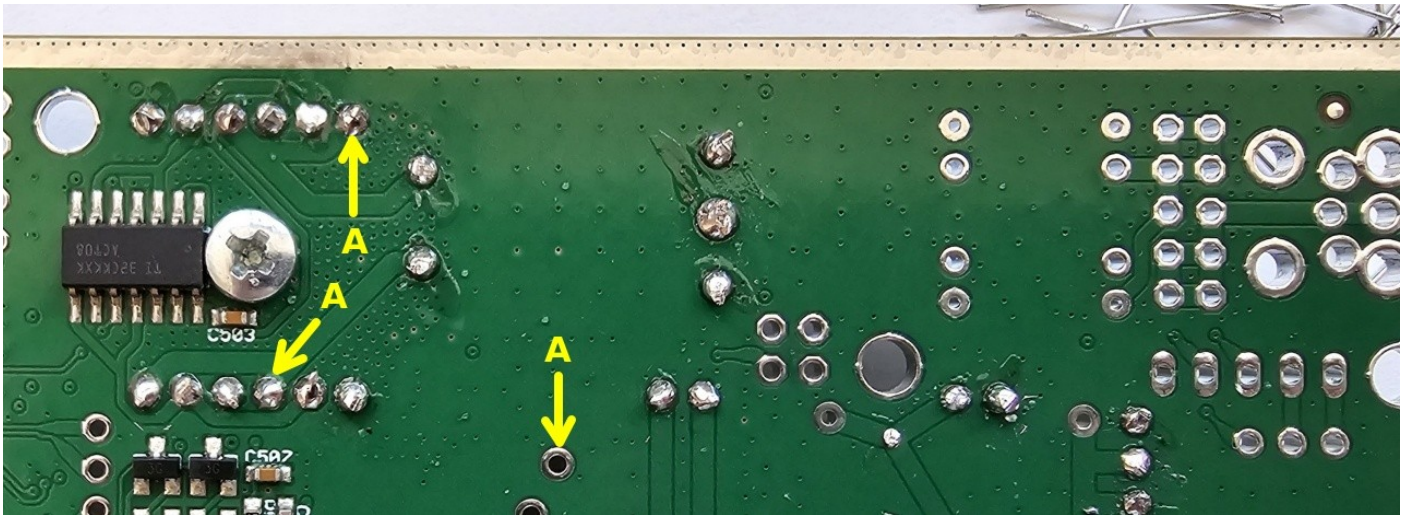

Now check for DC continuity with a DVM between all the points marked A in the photograph above.

These points are connected to the two left-hand (in the photograph) wires of transformer and the central wire of the three pads on the right hand side. The reason for putting the DVM probes on these three weird points rather than the transformer pads themselves, is that if you touch the DVM probes to the transformer pads you may connect directly to the copper wire itself; it won't then prove that you have made a properly soldered connection to the PCB.

Check that there is NO DC continuity from the points marked A, and ground. A convenient ground connection can be made by putting one DVM probe in one of the large plated grounded holes such as the one at the top left of the photograph above.

Now check that there is DC continuity from the end of C510 (SMD capacitor on the top side of the board) and ground, as shown by points B in this photograph (again the ground connection at B is just a plated through hole; again don't test directly at the transformer pads, see above):

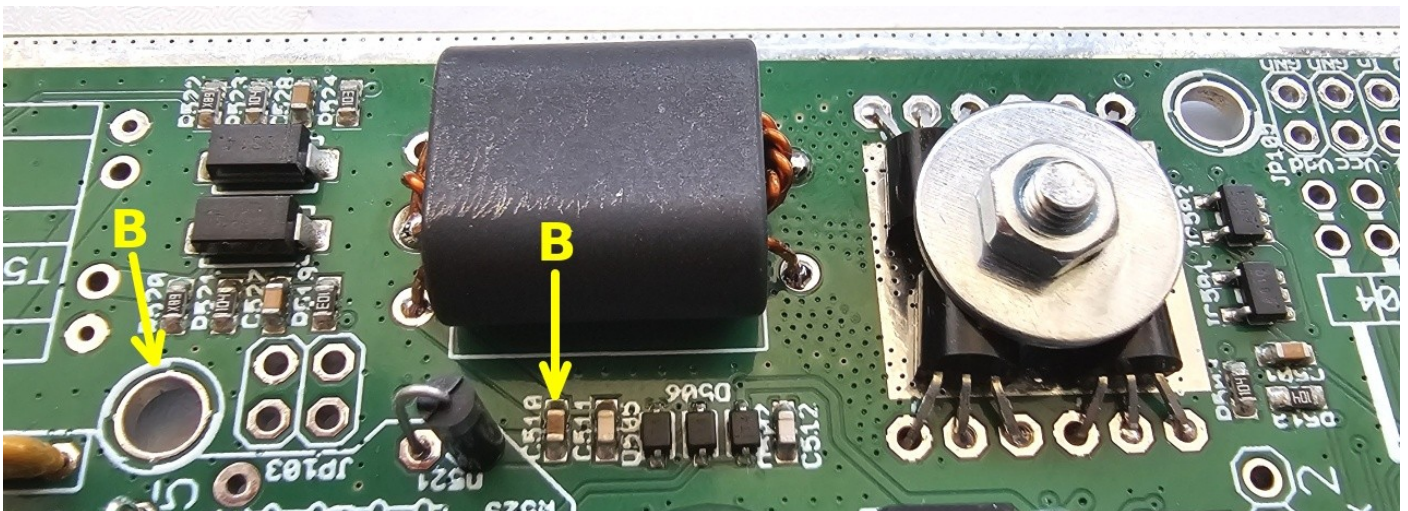

If any of the A-A-A points, or B-B points do not show DC continuity; or if you have DC continuity from the A-points to ground, it means you have a FAULT. Resolve it NOW before going further! Perhaps the transformer is wound incorrectly, or perhaps there is a short internally or near the ends due to enamel scraped off the wires.

2.10 Wind and install L502

L502 consists of 10 turns of 0.33mm (AWG #28) wire wound on an FT37-43 toroid (**dull black colour – be careful not to mix up with shiny T37-10 of your kit has them!**). (**Note: Photo shows 0.60mm wire but the kit now uses 0.33mm**). Firstly, you have to understand that there's a right way and a wrong way to wind a toroidal inductor, too. The terms "right" and "wrong" are probably not as appropriate here, as "handedness" or "winding direction". There are two directions you can wind the toroid. If you choose the right one, then all the wires will automatically end up near the holes they are to be soldered into. If you do it wrongly, it will be a bit messy.



For all the toroidal inductors in the QMX+ kit, you will get it right, if you start as shown (photo, above right) and pass the wire through the toroid from the top side down through the hole, out and then around and over again; accumulating turns in the anticlockwise direction.

With this in mind, wind 10 turns and install the toroid. As with the output transformer T501, I recommend scratching the enamel with a knife or wire-cutter, and then cutting it to about 2mm length on the underside of the board. Then solder, applying the soldering iron for at least 10 seconds and plenty of solder, to ensure a good connection. Do NOT tin the wires before inserting into the holes: the holes are not large enough to accommodate tinned wires.

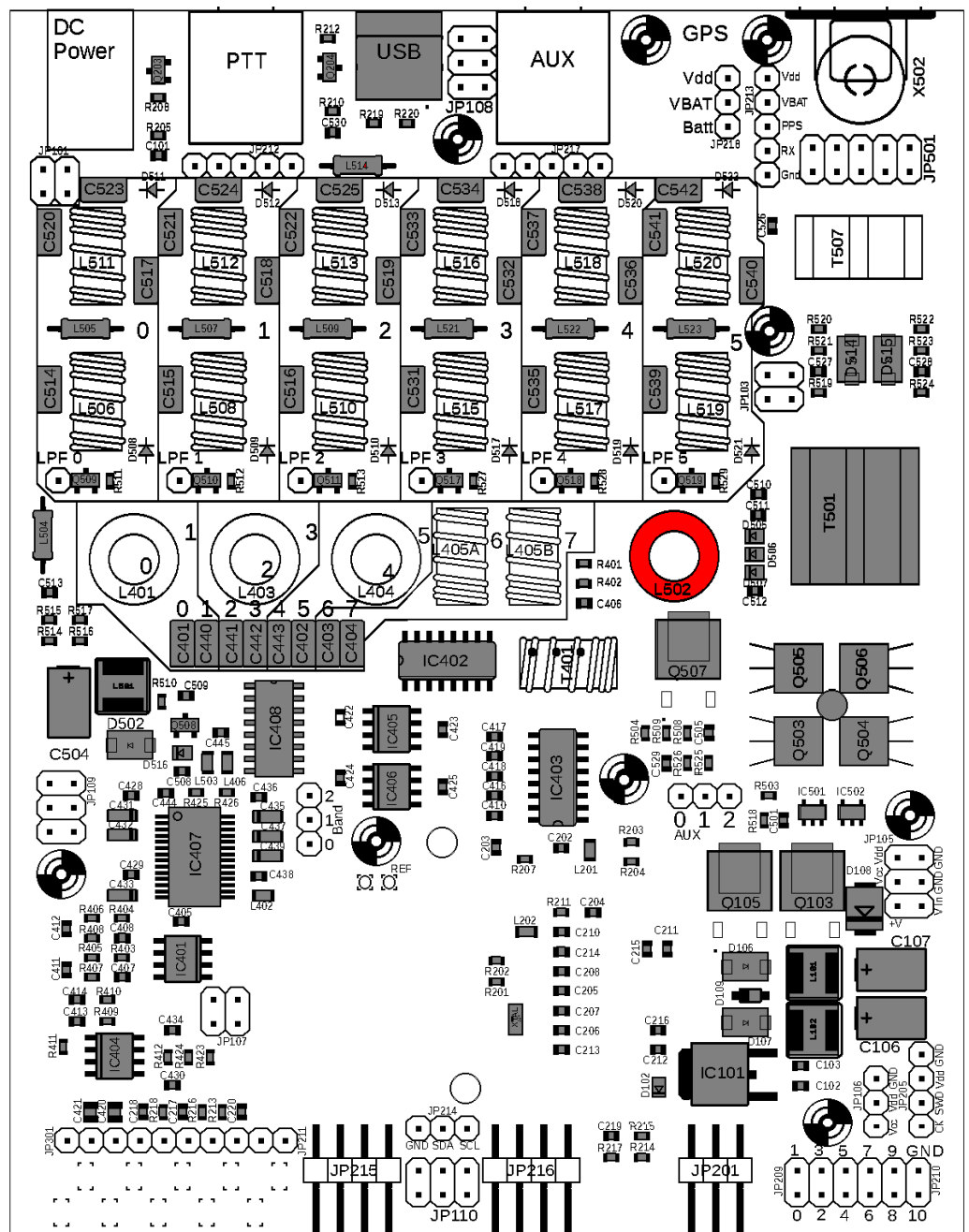

2.11 Wind and install Band Pass Filter toroids L401, L403-L405

Unlike on QMX where there is one single T50-sized toroids with multiple taps producing four Band Pass Filters, in QMX there are five toroids, each having a single tap, and this makes a total of eight BPFs. Using one toroid with one tap per two BPFs makes it much easier to optimize performance without getting unwanted interactions between taps due to parasitic resonances.

The exception is L405, where it proved impossible to obtain good 6m performance due to the interaction with the 10m winding. Accordingly TWO toroids are used for L405, which have been designated L405a and L405b. One end of the toroids is connected to the same point but winding the two inductances on separate cores avoids the unwanted parasitic interaction. The two toroids L405a and L405b are installed vertically, in the same space indicated on the board as L405. The other toroids L401, L403 and L404 are laid flat on the board.

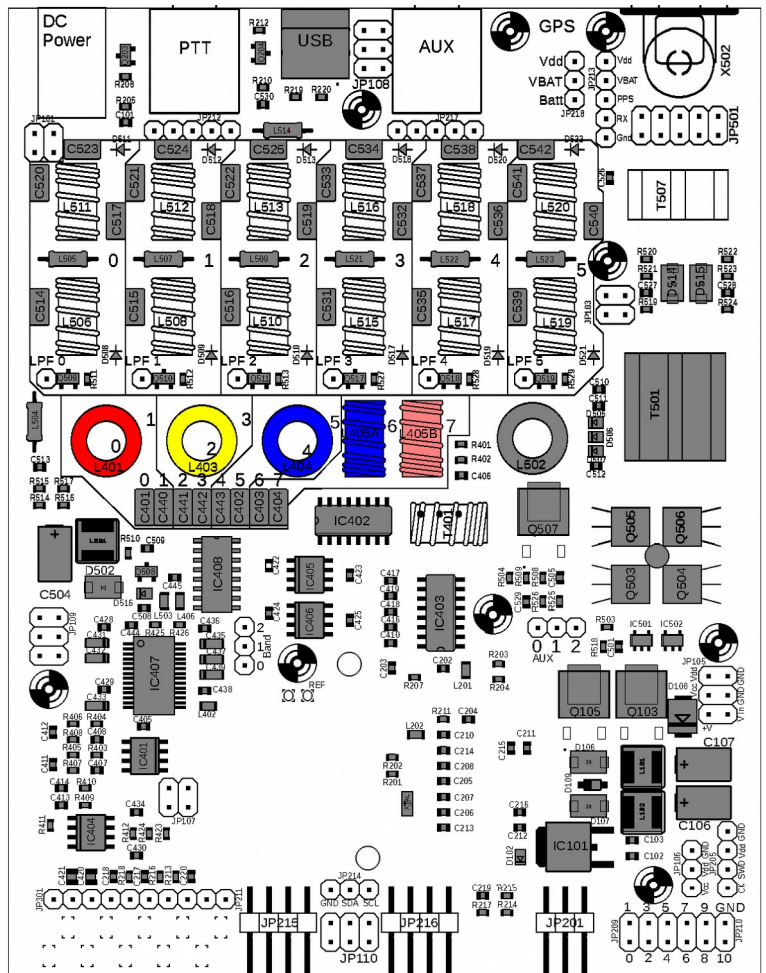

The five toroids are as follows:

- L401: T50-2 (red) for 160 and 80/60m – note the larger T50-size, compared to the others which are all T37-sized. L401 is the only T50-size toroid in the QMX+ kit.
- L403: T37-6 (yellow) **OR** T37-10 (shiny black) for 40/30 and 20/17m
- L404: T37-17 (yellow/blue) for 17 and 15m
- L405a: T37-17 (yellow/blue) for 12/11/10
- L405b: T37-0 (pink) for 6m

Note that we're calling the L405b toroid "pink"; it's not really all that pink but it's pink-ish compared to the more common type -2 material toroids which are definitely earthy red. In the QMX+ kit there is no possibility of confusing the toroids because the only type-2 toroid in the kit is L401 T50-2; all the red-ish T37-sized are the "pink" T37-0.

The winding and installation of L403 will be described in detail.

NOTE: L403 could be supplied as black T37-10 or yellow T37-6. All kits contain at least one T37-6 which is always used for L506. So check: if you have four shiny T37-10, then L403 is one of these! Take care not to MIX them up with the dull matt black FT37-43 toroids.

L401 and L404 follow the same principles. Cut 50cm of the thin (0.33mm) wire for L403. Not more than 48cm – which is more than plenty – otherwise the wire will run out before you finish all the

toroids. Note that if you do run out of wire or you have to re-do anything, exactly the same wire diameter is not critical. The number of turns is what matters. L403 has:

- T37-6 toroid (yellow): Total 30 turns with a tap at 19 turns.
- T37-10 toroid (black): Total 22 turns with a tap at 21 turns.

Remember: each time the wire passes through the center of the toroid counts as ONE turn.

Start winding with the wire coming in from the left, over the top of the toroidal core, and down through the hole, out to the right. You continue to fill up the toroid windings anti-clockwise around the core. The start of the winding will henceforth be indicated with 0.

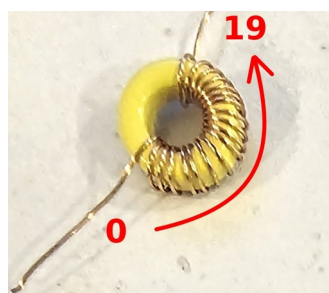
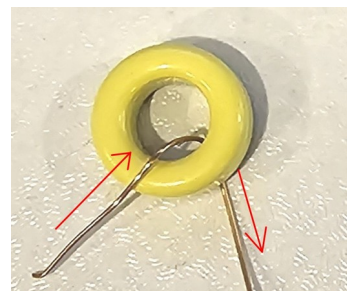

Continue winding 19 turns (or 21 on a black T37-10 toroid) onto the toroid, filling it up in an anti-clockwise direction.

After the 19'th turn (21 on black T37-10), create a loop protruding about 2cm or so from the core. Twist tightly as soon as the wire leaves the core.

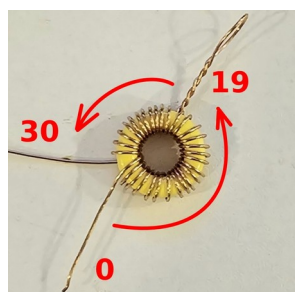
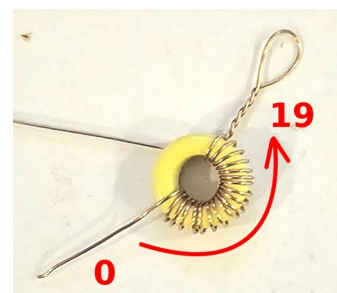

Continue winding to complete the whole 30 turns (33 turns for black T37-10).

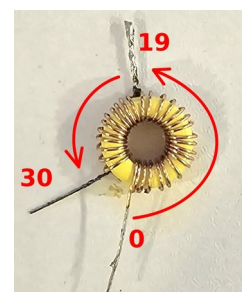

Now cut all three connections to a length of about 2cm and tin them with solder. The easiest way to do this put a big blob of molten solder on the iron tip, and apply it to the end of each wire (where you just cut it). The solder will easily burn off the enamel at the wire-ends then you can gently move the iron towards the toroidal core, burning off the enamel as you go. As per the picture, even the twisted section at the 19-turn tap (21-turns on black T37-10) gets tinned with solder nicely and evenly and easily. The holes on the board have a 1mm diameter so even after tinning the twisted 0.33mm wire, there will be no difficulty inserting the wire into the holes in the PCB.

Note that in the case where you find you need to re-work a toroid, or remove a turn, etc – trying to clean out the hole can be a tricky process. Never use implements such as a pin, that can damage the through hole plating. The easiest way to deal with it (not necessarily most beautiful) is simply to solder the wire to the pad on the top side of the PCB. The holes are through-hole plated anyway so you are assured of a good connection for the signal.

This diagram shows the installation of L403. Of course, it is absolutely critical that the three wires go into the correct holes. The START of your winding, identified as '0', must go into the hole nearest the line of capacitors, as indicated. The tap goes into

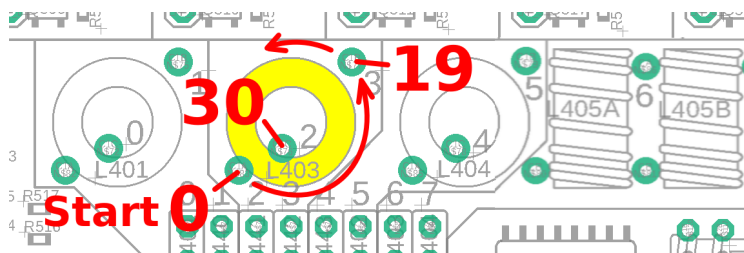

the hole marked '19' at the top right of the toroid, and the end of the winding goes into the hole marked '30' which is near the middle of the toroid.

Now L401 and L404 follow the same principles. This table details the number of turns required, and the type of core and length of wire. The wire will be PLENTY, do not cut more than the indicated amount. L403, you have done already (see above).

Part number	Toroid type	Number of turns	Length of wire
L401	T50-2 (large red)	0 – 33 – 44	85cm
L403	T37-6 (small yellow)	0 – 19 – 30	48cm
L404	T37-17 (small yellow/blue)	0 – 21 – 31	50cm

NOTE: Diagram shows yellow T37-6; if your toroid is a shiny black T37-10 it must be 33 turns tapped at 19.

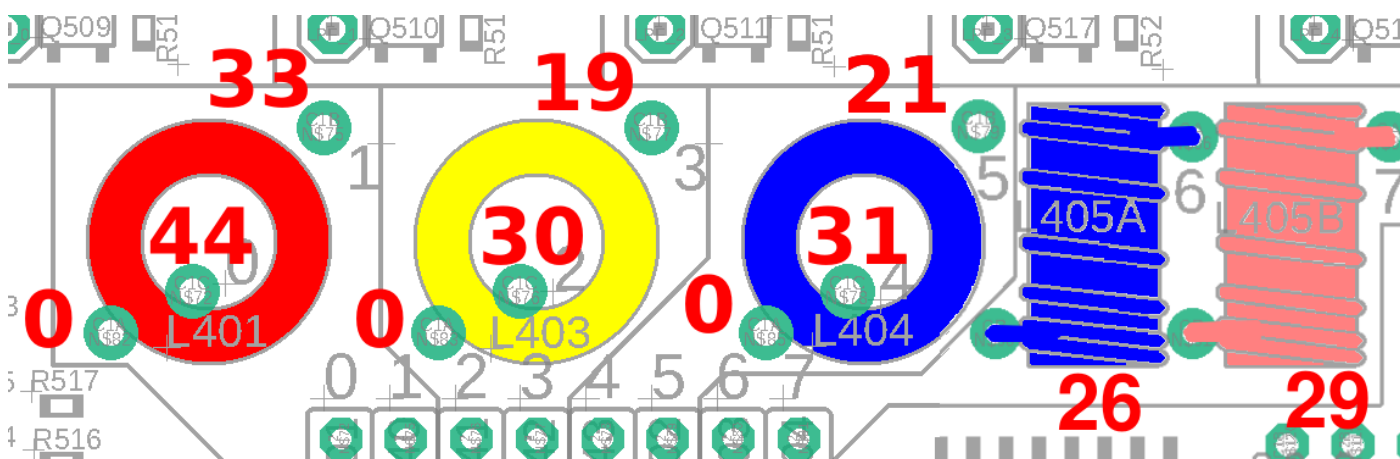

In all cases, the start of the winding indicated by turn 0, is the one at the bottom nearest the row of capacitors; the tap is at the top right, and the “far” end of the winding is near the middle.

The holes on the board are also numbered on the silkscreen: 0, 2 and 4 are the “far end” of the windings of L401, L403 and L404 respectively; 1, 3 and 5 are the 33-turn, 19-turn and 21-turn taps of L401, L403 and L404 respectively.

Now L405a and L405b are wound as normal toroids, with no tap, according to:

Part number	Toroid type	Number of turns	Length of wire
L405a	T37-17 (small yellow/blue)	26 turns	38cm
L405b	T37-0 (small pink)	29 turns	47cm

These two toroids are to be installed in positions L405a and L405b.

Which way around the toroids goes doesn't matter (which wire is considered the “start” and which the “end”); arrange it whichever way seems neatest to you.

2.12 Install Low Pass Filter toroids

There are 12 Low Pass Filter toroids, all wound using the 0.33mm (AWG #28) enameled wire. Remember, as per the previous instructions, using the right winding direction will make the toroids much easier to fit to the PCB. Refer to the table below. Make sure to count carefully and install the toroids in the correct places! Remember that each time the wire passes through the center of the toroid counts as one turn. Spread the turns evenly with a small gap. Winding the toroids as tightly as possible will slightly improve the performance of the Low Pass Filters. But don't pull so tightly that you break the wire!



The following table lists the required toroids, number of turns, cut wire length; the diagram below also shows the toroid type and number of turns. Note that the Inductance column shows the theoretical inductance modeled. This is only then a guide for experimentation during the development phase, the practical result differs from the model inevitably. Therefore it is recommended to not get too fancy, don't try to measure using an LC-meter etc., just count turns, evenly space them around the core, and let's see how it goes.

NOTE: that L508, L511 and L512 may be supplied as either yellow T37-6 toroidal cores or shiny black T37-10 cores. Be careful NOT to mix up the shiny black T37-10 cores with the dull matt black FT37-43 (every kit contains two FT37-43).

However, L506 is always a yellow T37-6 toroid.

Band	Part number	Core	Inductance	Number of turns	Wire length
160m	L511	T37-6 (Yellow) OR T37-10 (Black)	3.54uH	34 (yellow toroid) 37 (black toroid)	48cm / 50cm
160m	L506	T37-6 (Yellow)	4.42uH	38	53cm
80 / 60m	L512	T37-6 (Yellow) OR T37-10 (Black)	1.55uH	22 (yellow toroid) 24 (black toroid)	33cm / 34cm
80 / 60m	L508	T37-6 (Yellow) OR T37-10 (Black)	1.83uH	25 (yellow toroid) 27 (black toroid)	37cm / 38cm
40 / 30m	L513	T37-17 (Blue/yellow)	866nH	21	32cm
40 / 30m	L510	T37-17 (Blue/yellow)	1.03uH	23	34cm
20 / 17 / 15m	L516	T37-0 (pink)	435nH	24	36cm
20 / 17 / 15m	L515	T37-0 (pink)	518nH	26	38cm
12 / 11 / 10m	L518	T37-0 (pink)	268nH	23	34cm
12 / 11 / 10m	L517	T37-0 (pink)	313nH	25	37cm
6m	L520	T37-0 (pink)	160nH	14	23cm
6m	L519	T37-0 (pink)	188nH	15	24cm

Low pass filters for shiny black T37-10 toroids (see next page for yellow T37-6 toroids):

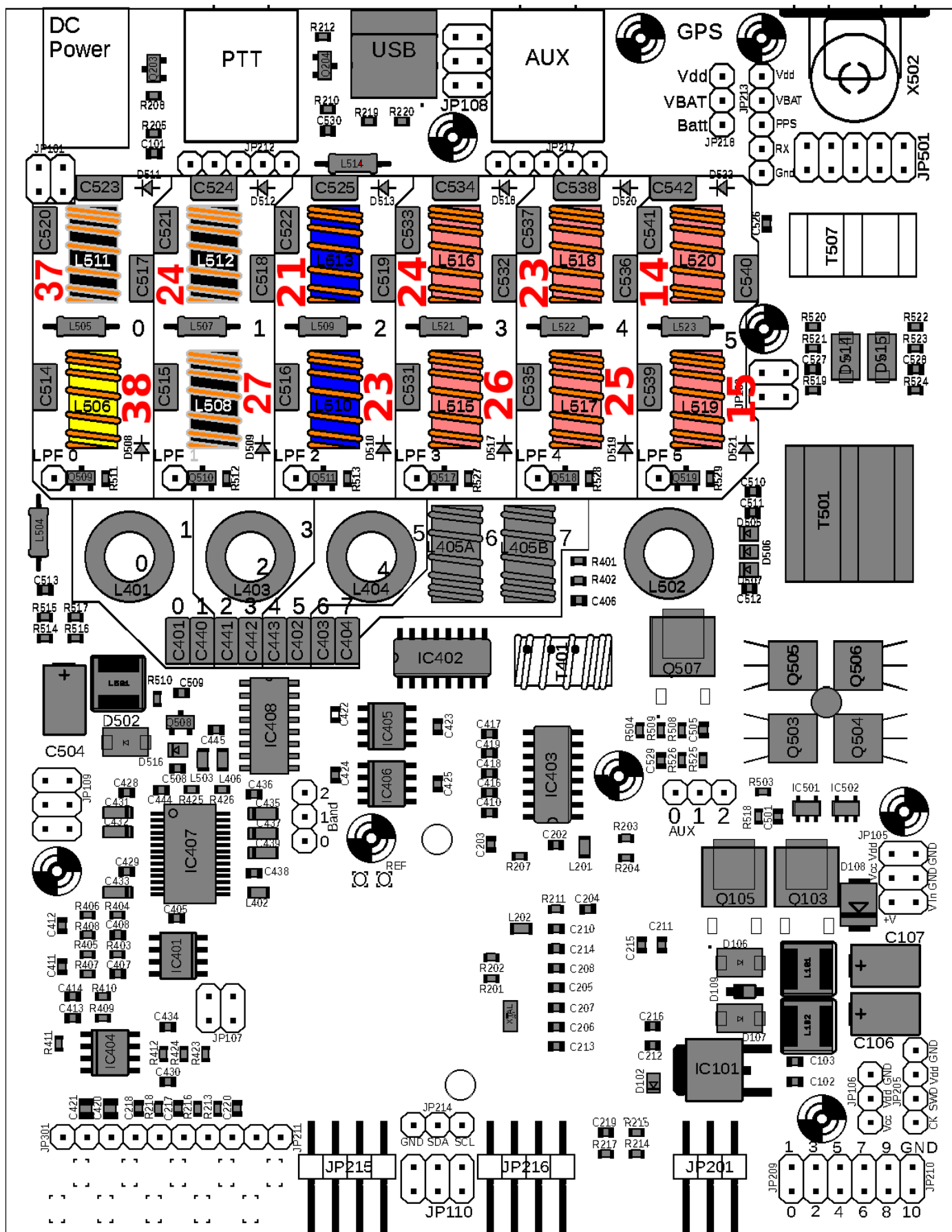

Low pass filters for yellow T37-6 toroids:

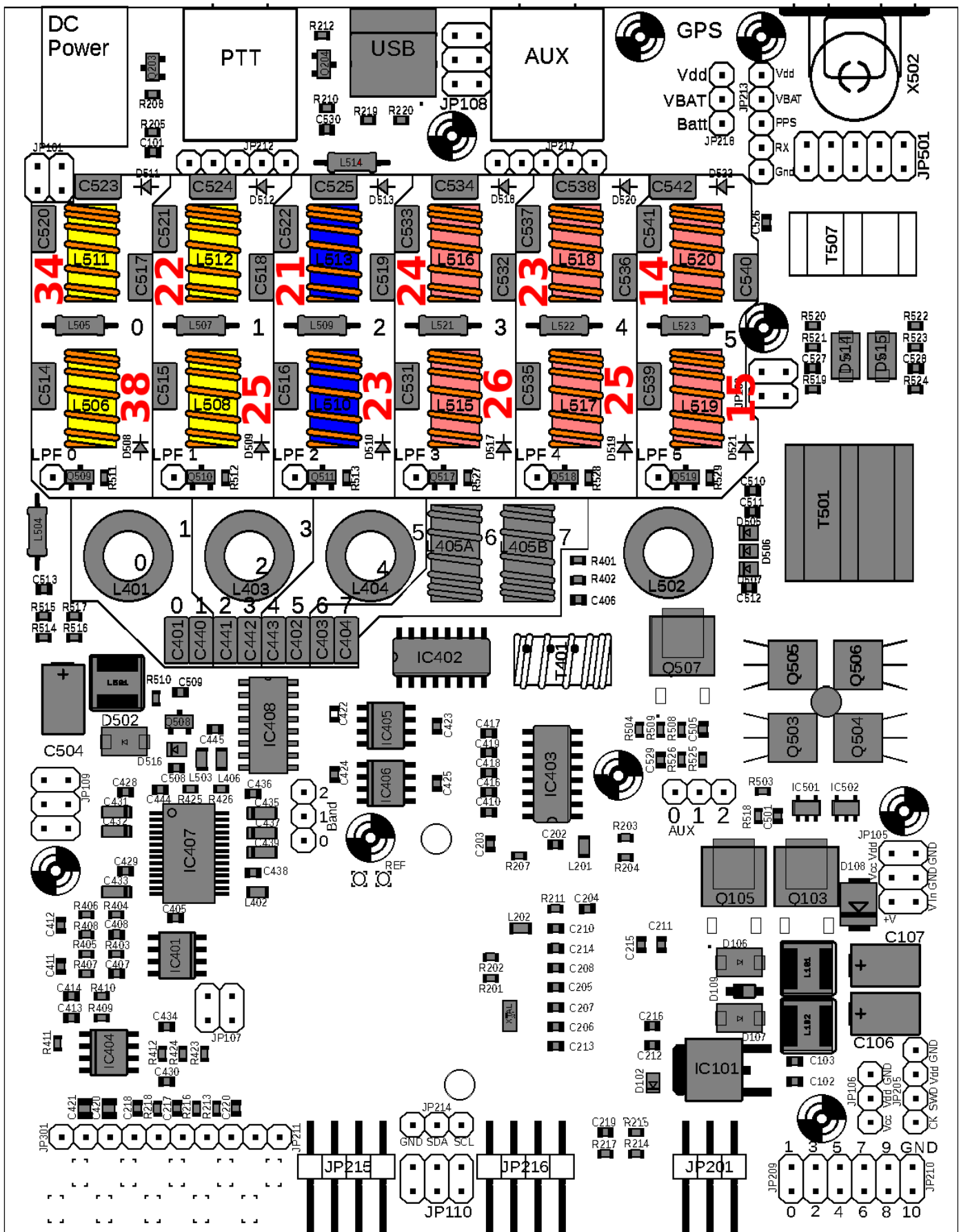

2.13 Wind and install trifilar toroid T401

This toroid needs some care so please follow these instructions very carefully.

Cut three 20cm lengths of 0.33mm (AWG #28) wire. These three pieces now need to be tightly twisted together to make the trifilar wire. My method for this is to tie one end in a knot around a small screwdriver shaft. Similarly tie the other end around another small screwdriver. Now clamp one end somehow to something solid. You could use a vise, if you have one. If you don't, then you have to get creative and think of something. Here I taped it to the edge of the desk. Now you can twist the screwdriver at the free end, repeatedly until you twist the three wires together thoroughly. You need to keep the wire under a little tension to keep the twists evenly spaced.

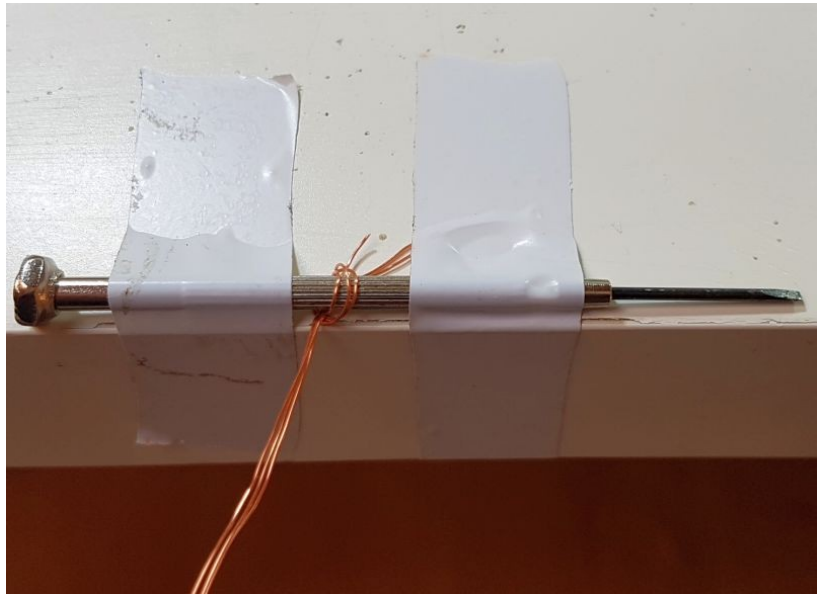
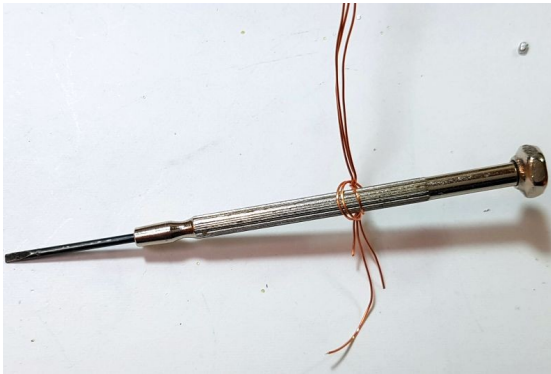
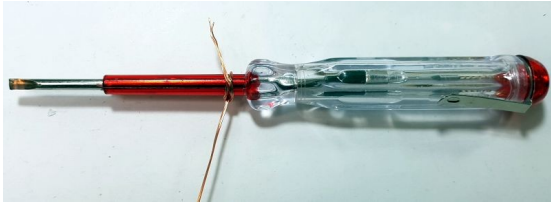

A 20cm length of wire should have about 60 twists. It is not critical.

The end result is something like the photo (right). The measurement scale is in cm.

Now cut off the untidy ends, and this is the piece of wire that will be used to wind the FT37-43 toroidal core as a trifilar transformer (matt black not shiny black T37-10!).



Hold the core between thumb and finger. Pass the wire first from above, to below. Then take the wire from below, and bring it around to pass through the toroid again to form the second turn. After each turn, ensure the wire is fitting snugly around the toroidal core. Wind 10 turns on the core. Each time through the toroid's central hole counts as one turn. Cut off the excess wire, leaving about 2cm remaining.

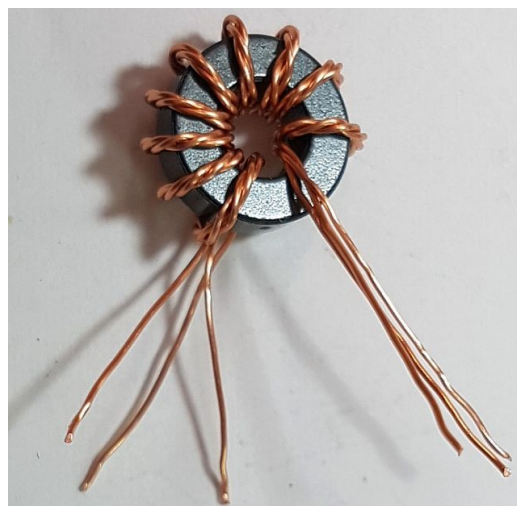
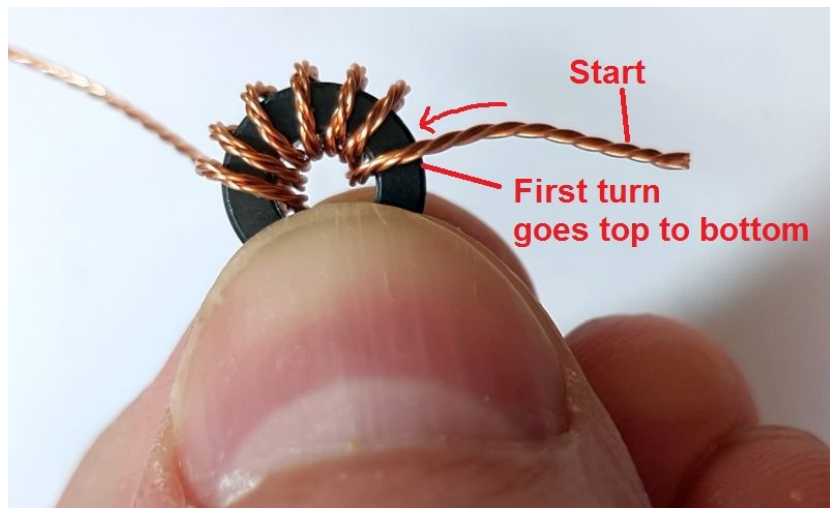

Now it's necessary to identify which wire belongs to which winding. You have three windings twisted together, they all use the same wire. The only way to do this is with a DMM as continuity tester. First, untwist and straighten the wire ends that are not wound around the toroidal core.

Now tin the last few mm at the ends of each wire. You can do this by scraping off the enamel then tinning with the soldering iron; or, if your soldering iron is powerful enough, hold the wire end in a blob of molten solder for a few (maybe 10) seconds, until the enamel burns off.

Now use a DMM to test for continuity. Re-arrange the wires so that there is continuity from A-A, B-B, and C-C in this photo.

Carefully keep this orientation of wires and insert the transformer this way into the PCB. BE CAREFUL not to lose the orientation of the wires! The right wires must be in the right holes, so that the windings are connected correctly in the circuit!

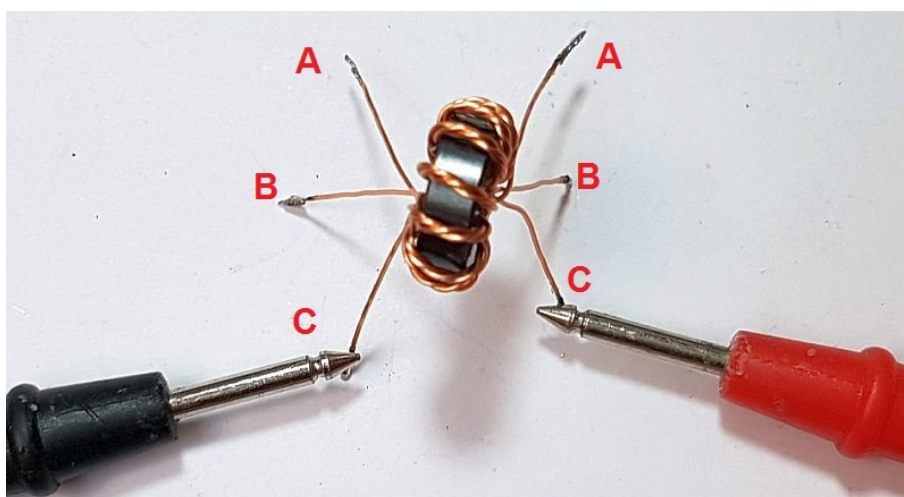

Refer to the diagram on the following page to see the correct orientation.

Once the wires are inserted through the correct holes in the PCB, and pulled tight, check for continuity between the pairs of wires in holes A, B and C once AGAIN. It is much easier to get this right first time, than it is to make repairs later!

When you are satisfied that the wires are all in the correct holes, you can cut them to a length of about 2mm and solder them. It is best to cut-and-solder one wire at a time, since if you cut all the

wires to 2mm length then the toroid is more likely to fall out before you've had a chance to solder any of the wires. If that happens, it will be tough to get all the wires back in the correct holes again.

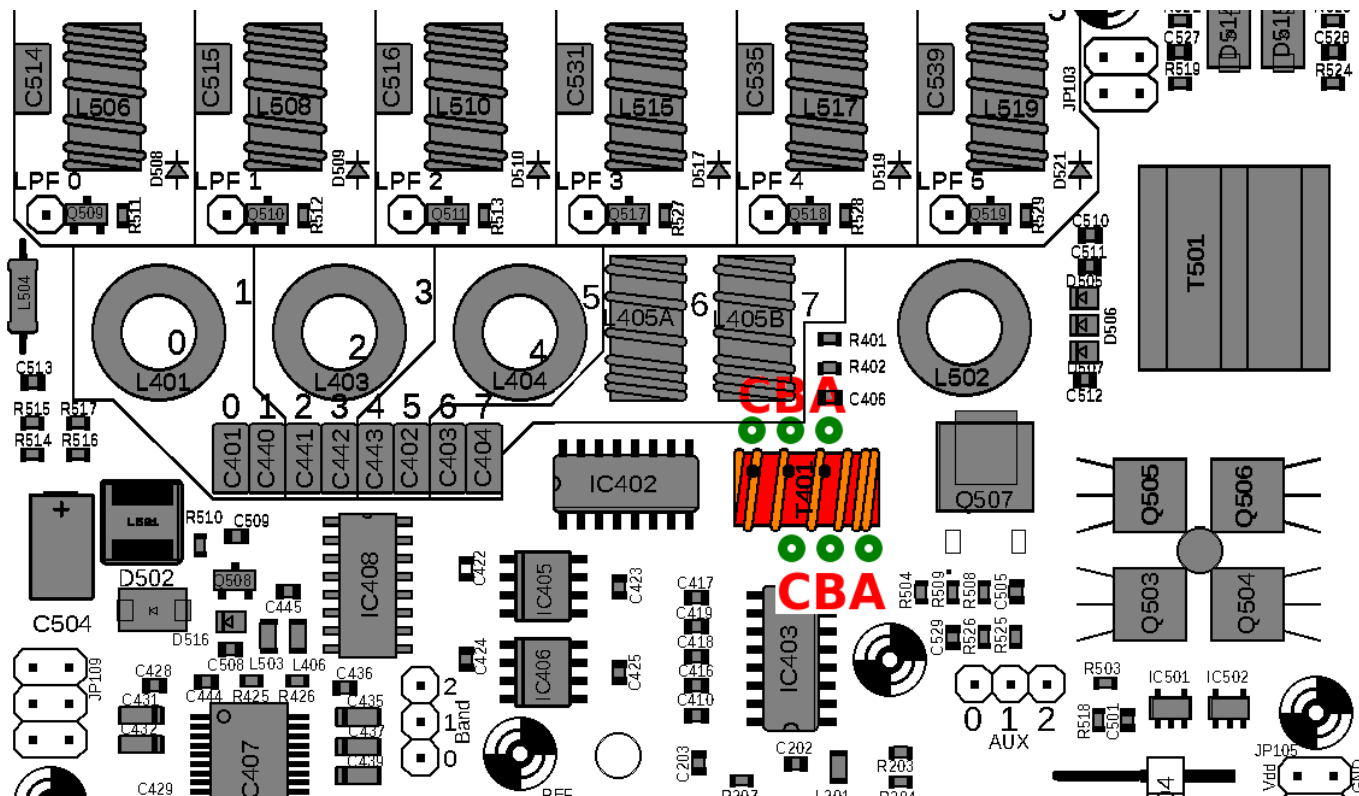

Be careful when soldering the wires of toroid T401, NOT to touch any of the nearby SMD components! Once again my method involves holding the iron and plenty of solder on the joint for at least 10 seconds to make sure the enamel burns off completely.

The photograph (right) shows the board after installation of T401. You can use a DVM in continuity testing mode (or check for zero ohms resistance) to verify all connections are correctly made. You should see DC continuity between all the pads of T401 and IC402 pin 9, IC403 pins 7 and 9, and the right hand side of SMD capacitor C406 (indeed the right hand side of R401 and R402 also). These points are identified by the yellow arrows in this photograph.

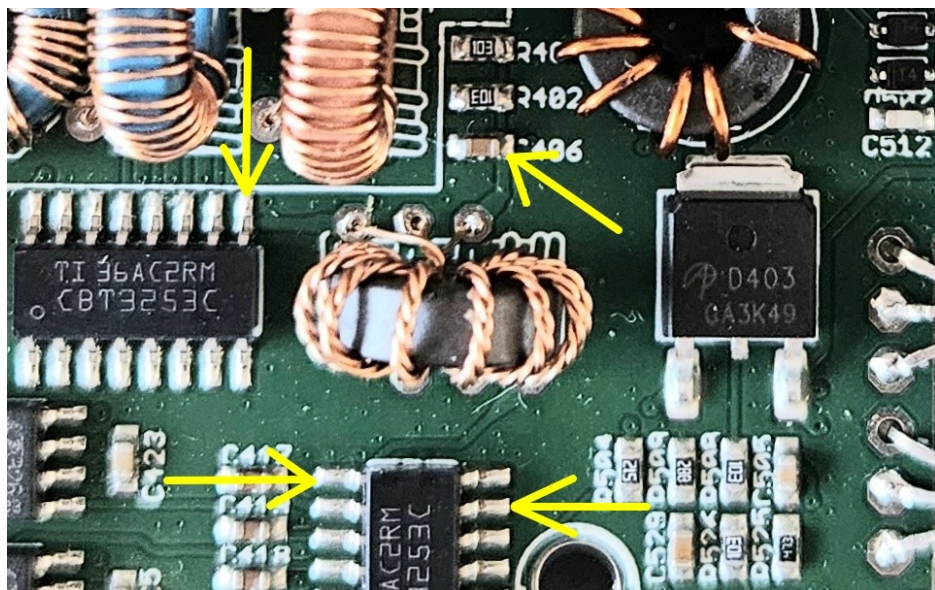

2.14 Wind and install transformer T507

Cut two lengths of 0.33mm wire, each approximately 25cm long. Wind 10 turns through each hole of the BN43-1502 binocular core. Cut two 25mm lengths of 0.33mm wire (**note, previously 0.60mm was used**). These are threaded only ONCE through each hole.

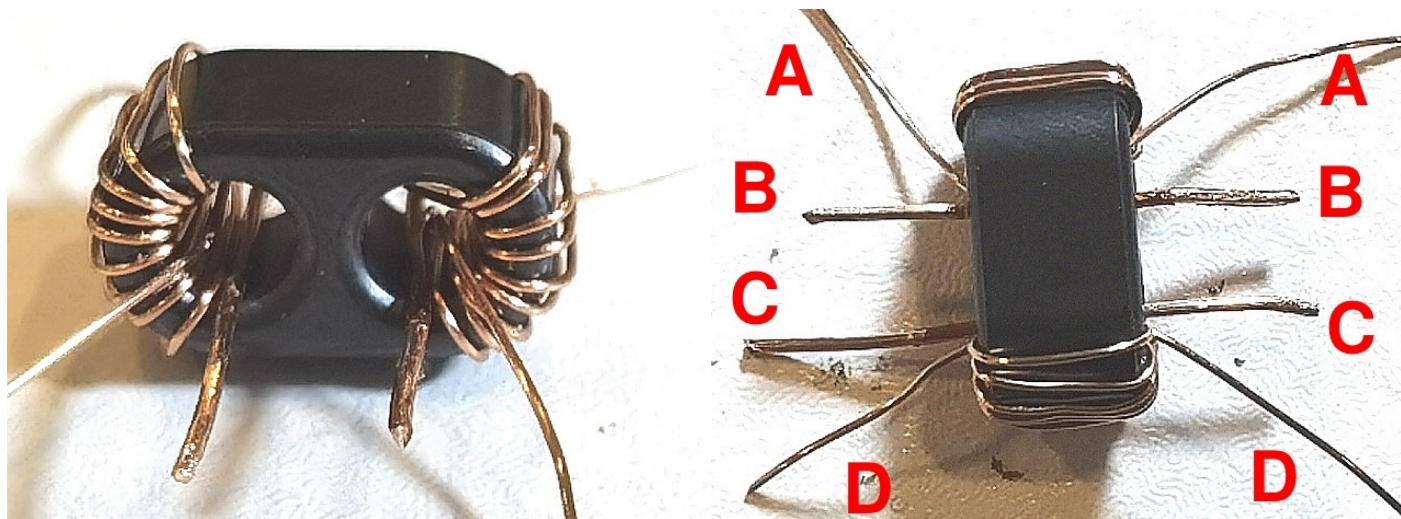

The transformer is installed as shown on the diagram. The single-turns (ONE time through the hole) are installed at B-B and C-C. The enamel needs to be scraped off the ends before installation but not tinned (it would not fit in the holes). The ends of the 10-turn windings are fitted at A-A and D-D.

Also use a capacitor off-cut wire (remember you saved them?) to create a jumper wire between the two middle pads of JP501 as shown; insert a piece of wire and solder it on the underside of the board.

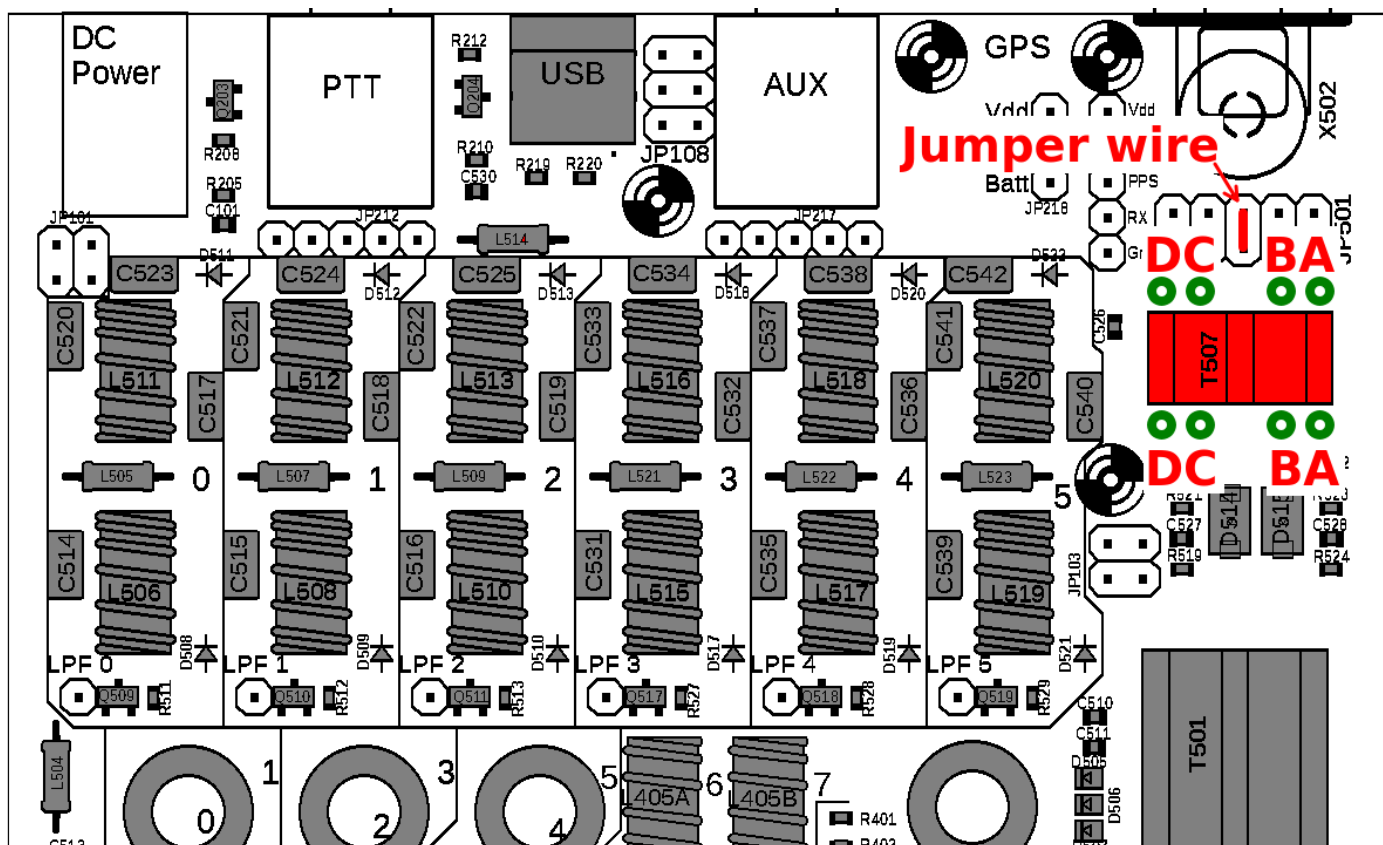

2.15 Install rear panel connectors

Install the four rear panel connectors as follows (USB-C is already SMD assembled):

- X101: DC Power connector
- X201: 3.5mm jack: PTT output
- X218: 3.5mm jack: AUX connection
- X502: BNC RF connector – NOTE: there is a footprint for an SMA connector that you may install if you wish; however this will have gaps around it as it pokes through the enclosure.

It is very important to install these carefully aligned so that they are straight and at right-angles with respect to the PCB. The connector body should be installed square and not protrude beyond the edge of the PCB. 3.5mm stereo jack connectors X201 and X218 will try to NOT sit at 90-degrees, they will try to sit slightly twisted; it is important to apply necessary force to hold them in the correct 90-degree orientation with respect to the board edge, during soldering.

When the connectors are well-aligned, you will have no trouble fitting the PCB into the optional enclosure. A very good strategy is to bolt the enclosure's rear panel to the BNC connector during installation to make sure that everything sits square (90-degrees).

Clip off excess leads and tabs to make sure nothing protrudes more than 1.5mm.

It's a good idea to inspect the USB-C connector soldering (labeled J201). This is a high quality part with through-hole pins which are designed to be soldered by SMD machines, however in practice the SMD assembly process doesn't apply much solder. All boards' USB connectors are tested before shipment. But it is probably still worth touching up the connections to make sure all the joints are electrically and mechanically sound, including the mounting tabs. Be very careful to avoid any solder bridges short-circuiting the pins of the connector, which are very close-spaced.

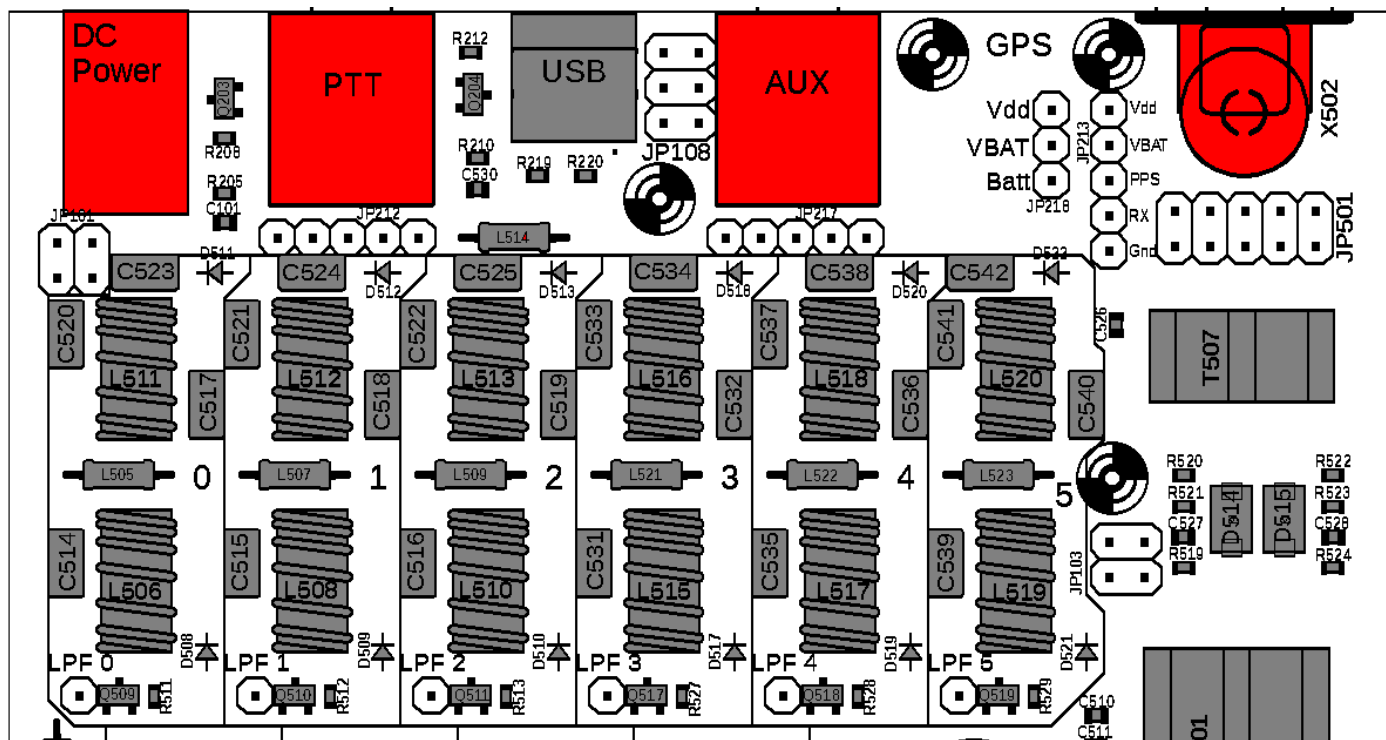

2.16 Install right-angle front panel pin header connectors

Install the following 90-degree male pin header connectors:

- 2x4-pin 90-degree male header connector JP215
- 2x4-pin 90-degree male header connector JP216
- 2x3-pin 90-degree male header connector JP201

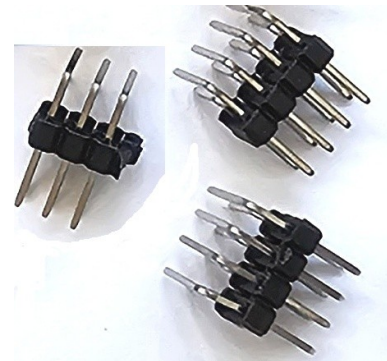

Be careful to ensure that the pin headers are accurately aligned, they should sit square in the PCB, with the pins matching the silkscreen legend, not at a slightly twisted angle.

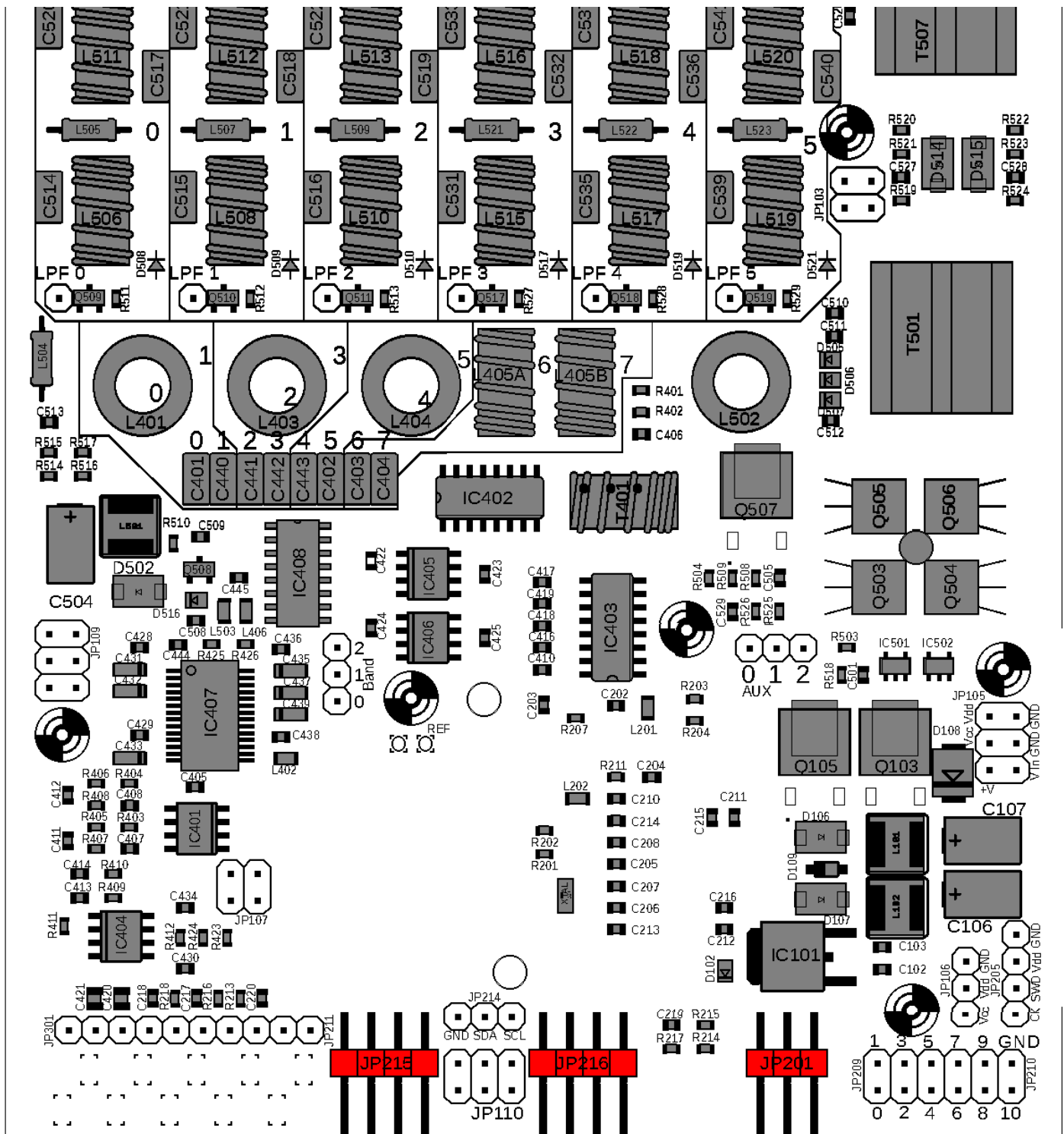

2.17 Install Audio and Paddle connectors

The audio and paddle connectors are 3.5mm stereo jack sockets of the same type as the AUX and PTT out connectors on the rear panel. They need to be installed on their own small PCB, which is attached to the main PCB using the capacitor wire off-cuts you kept from earlier. In the end, the appearance of the front half of the PCB is like this:

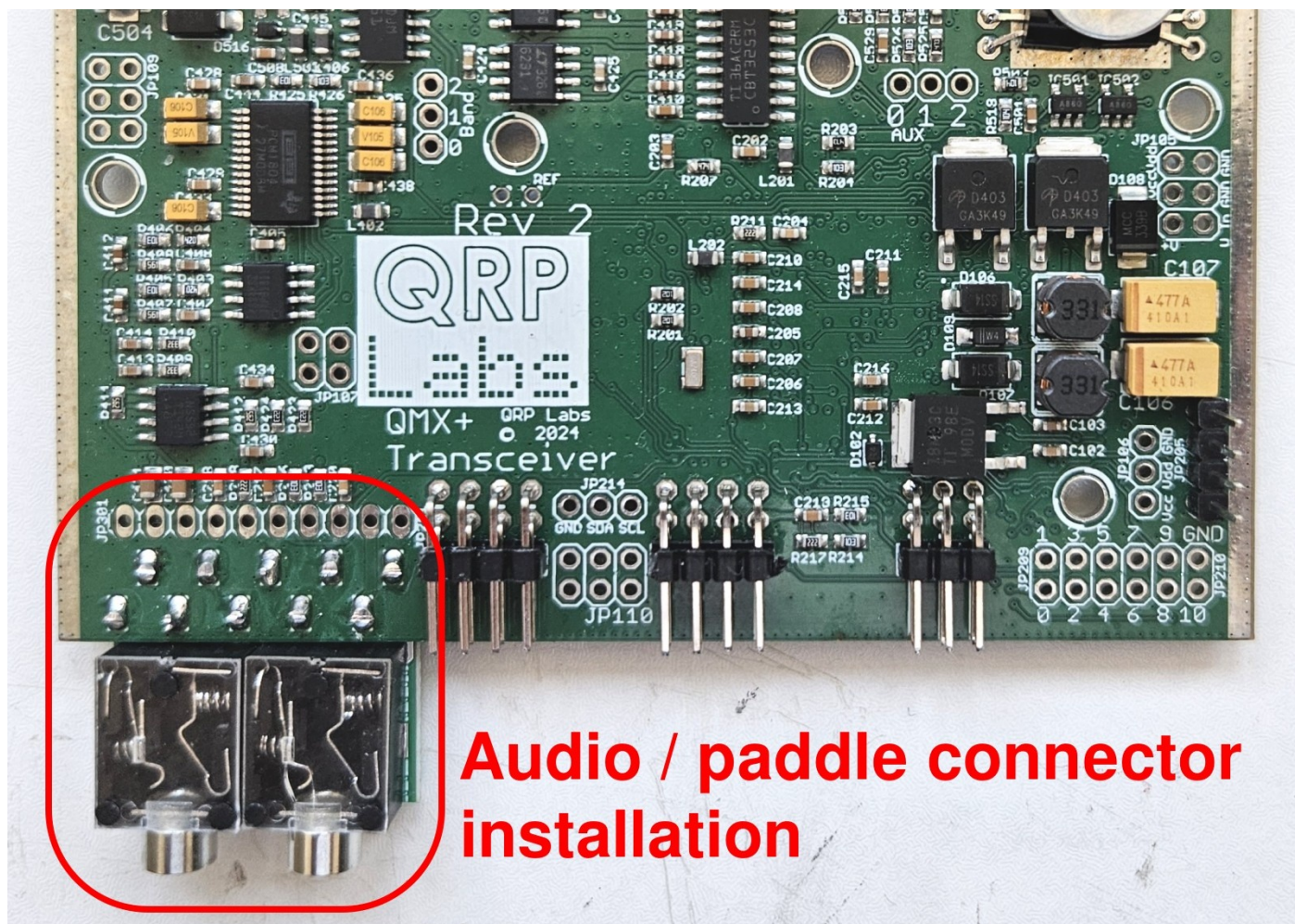

Insert the two connectors on the side of the PCB labeled “Top” which has the outline of the connectors on the silkscreen. Solder them on the side labeled “Bottom”.

Again it is very important that the body of the connectors is square, make sure that the connector body edges line up with the white outline on the silkscreen.

Solder one pin first, and then add one more pin one at a time, checking the alignment at each step.

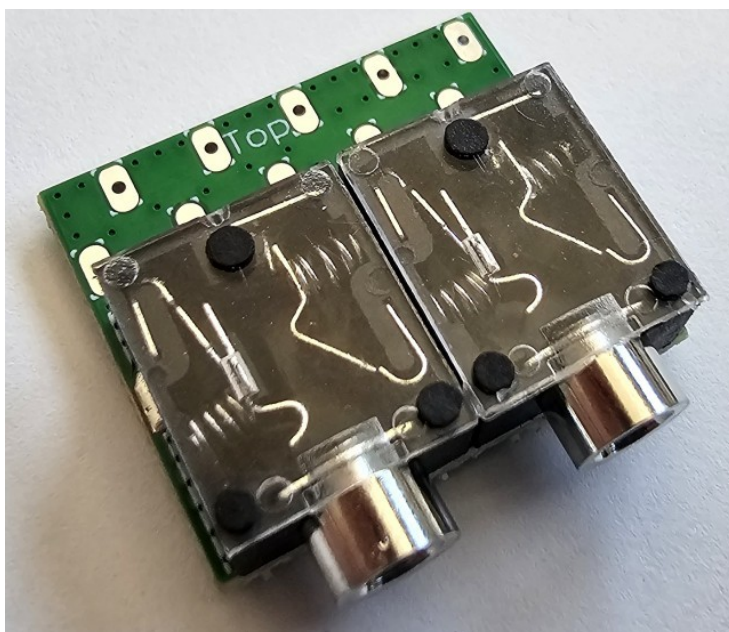

This small connectors PCB has ten connecting holes to the bottom left corner of the main board. You will insert capacitor offcut wires into these holes and solder on each side, to fix the connector board to the main PCB.

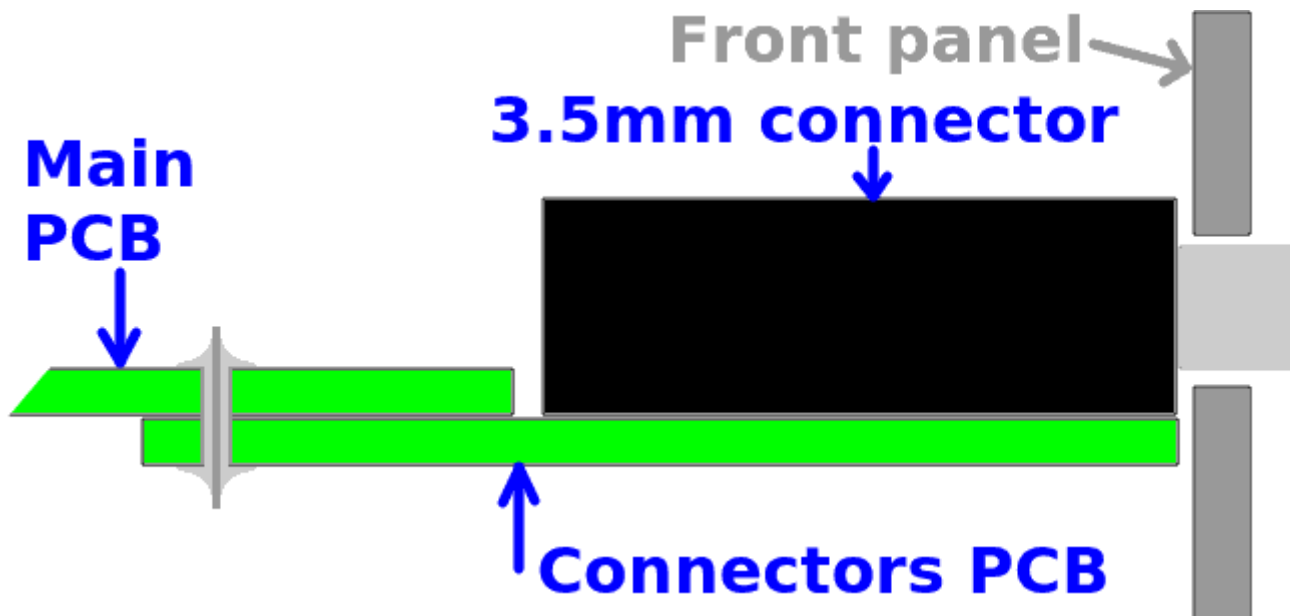

It's very important that the connectors PCB must be UNDER the main PCB. Study this section and all the diagrams and photographs, before soldering.

Insert 10 capacitor offcut wires into the holes, making sure that the connectors PCB and the main PCB are accurately aligned, and that the wires pass all the way through the holes in both boards. To a certain extent the 10 wires will ensure good alignment.

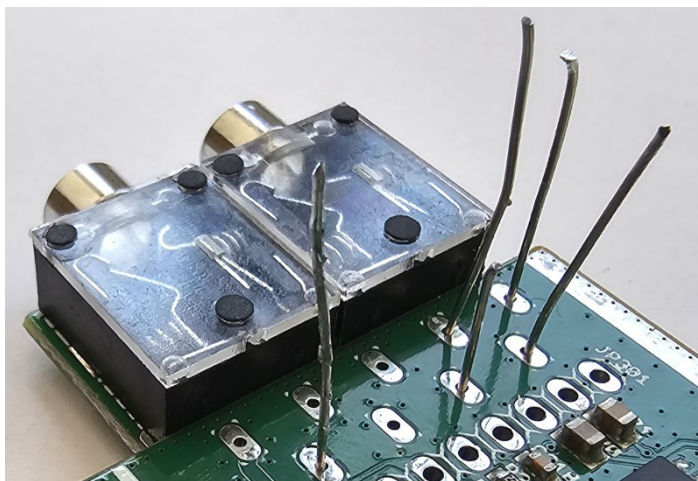

When you are sure everything is properly aligned, you can start soldering, on both sides of the boards; for each wire make sure that it still passes all the way through the holes of both boards before soldering.

Two more views of the situation:

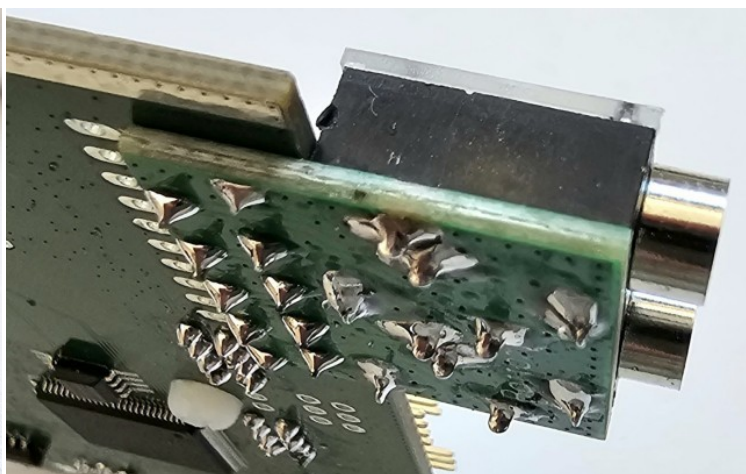
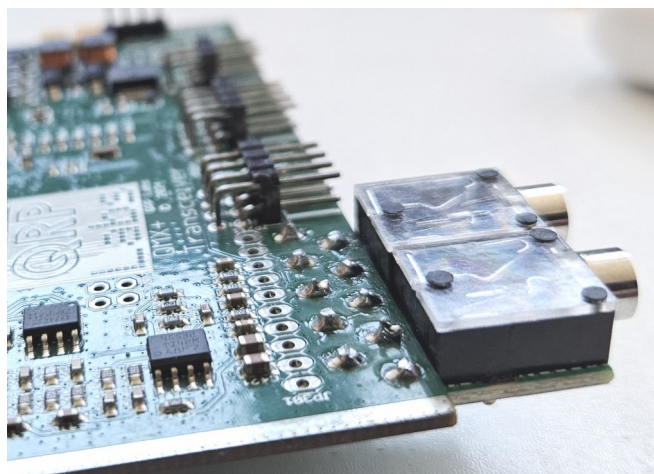

2.18 Install R305 contrast trimmer potentiometer

This trimmer is installed on the BACK (bottom) side of the front panel PCB!

Be very careful to solder this on the correct (front) side of the PCB, it will be very difficult to remove afterwards if you get it wrong now. **Adjust the trimmer to the fully anti-clockwise position.**

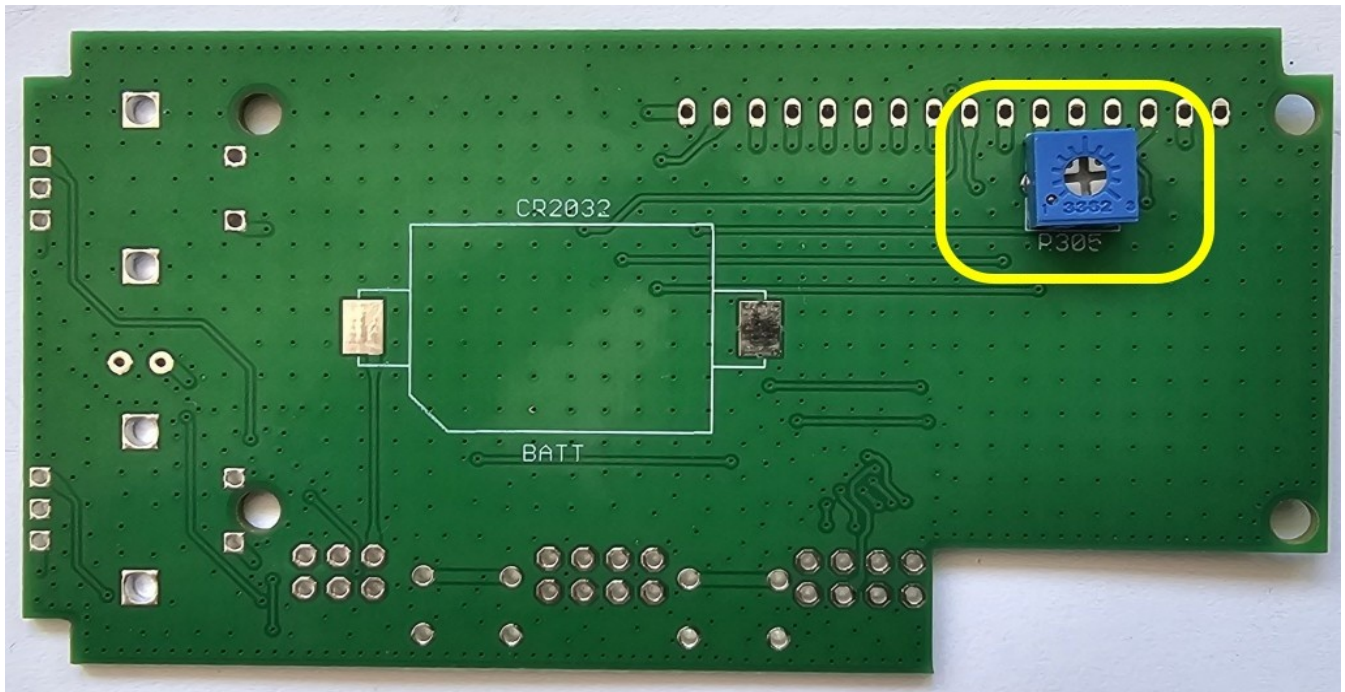

2.19 Install female pin headers JP301, JP302 and JP304

The connectors are installed on the BACK (bottom) side of the front panel PCB!

Install two 2x4-pin female header connectors and one 2x3-pin female header connectors on the REAR side of the board, with the soldering on the front side. Ensure accurate alignment.

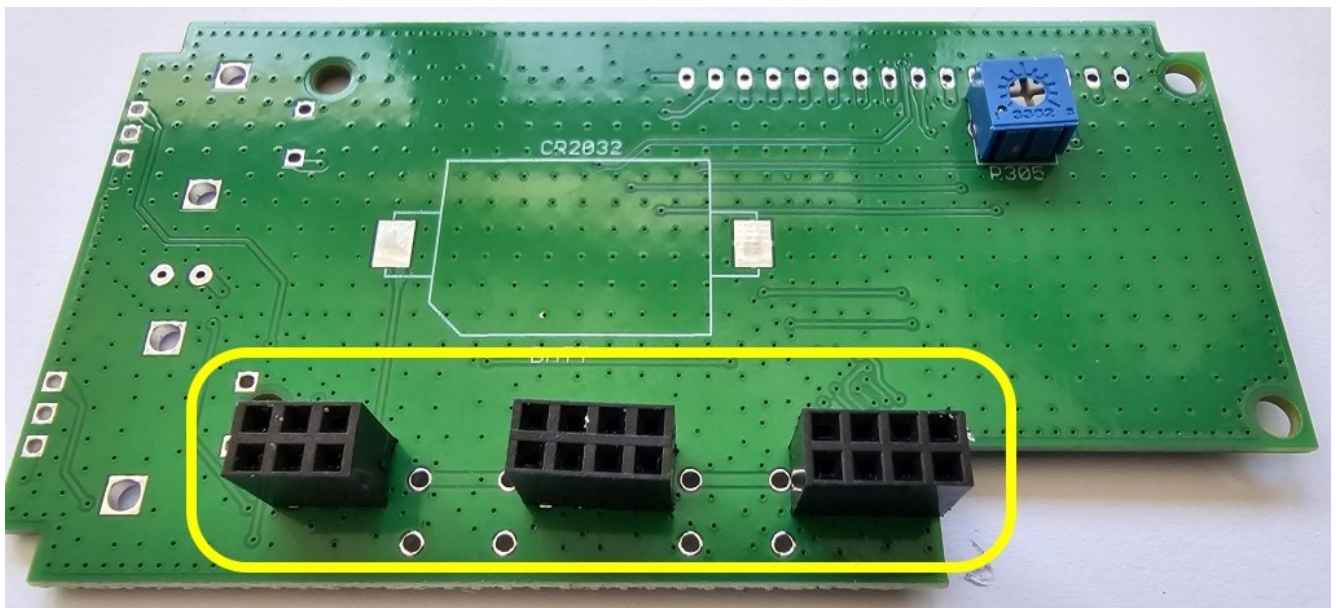

2.20 Install CR2032 battery holder

The CR2032 battery holder is an SMD component which is easily soldered by hand. Just a blob of solder on the terminals suffices. Correct orientation is ensured by observing the cut-off corner and making sure it is at the bottom left: critical for correct battery polarity!

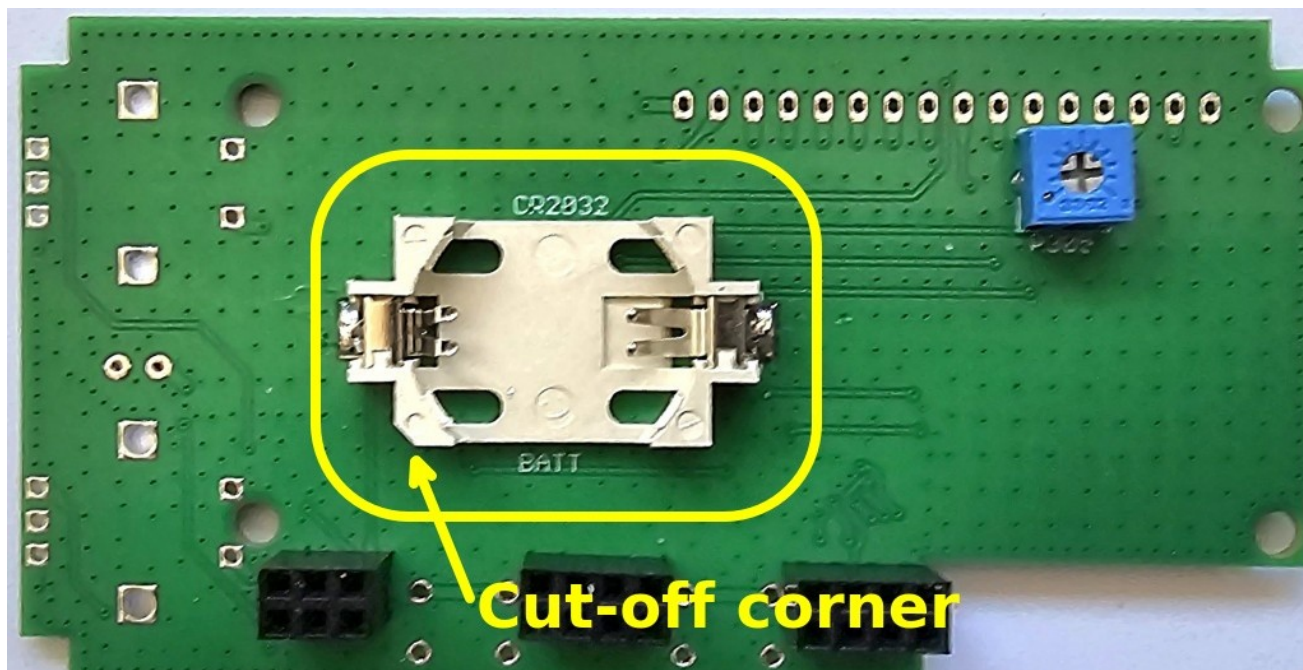

2.21 Install microphone

The microphone is installed on the front side of the front panel PCB. The microphone's rear has a little '+' printed on it, which should be inserted into the left hole. The pins of the microphone will need spreading slightly to fit in the holes. When orientated correctly the microphone will coincide with the white circle on the PCB silkscreen.

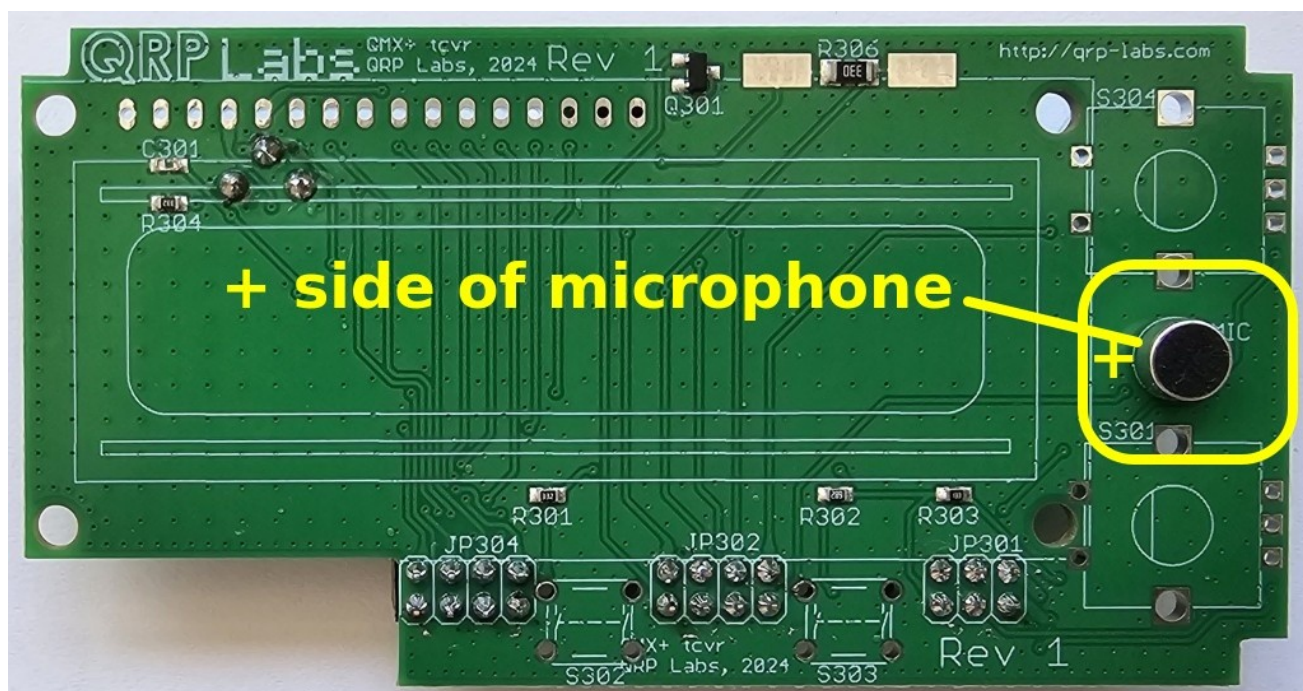

2.22 Install push-button switches S302 and S303

Install the push-buttons on the front side of the PCB. When soldering on the rear, holding the soldering iron on the side of each pin nearest the middle of the switch will avoid melting the adjacent pin headers.

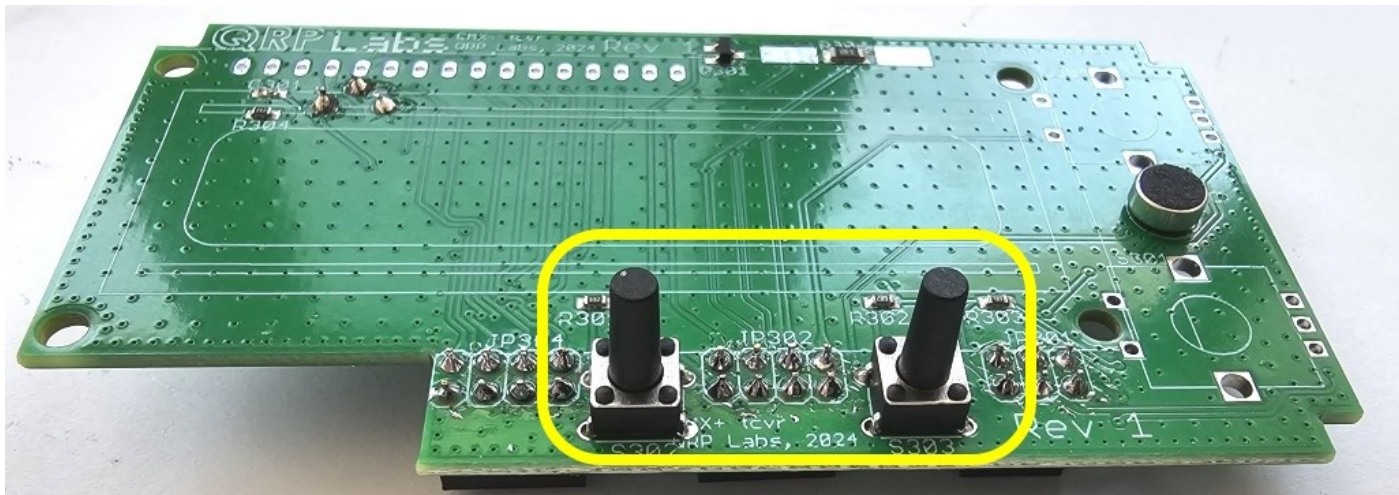

2.23 Install rotary encoders S301 and S304

Install the rotary encoders on the front side of the PCB but do NOT solder the two left pins of the "Tune" rotary encoder yet.

Instead, bend these pins over on the back side, away from the nearby hole.

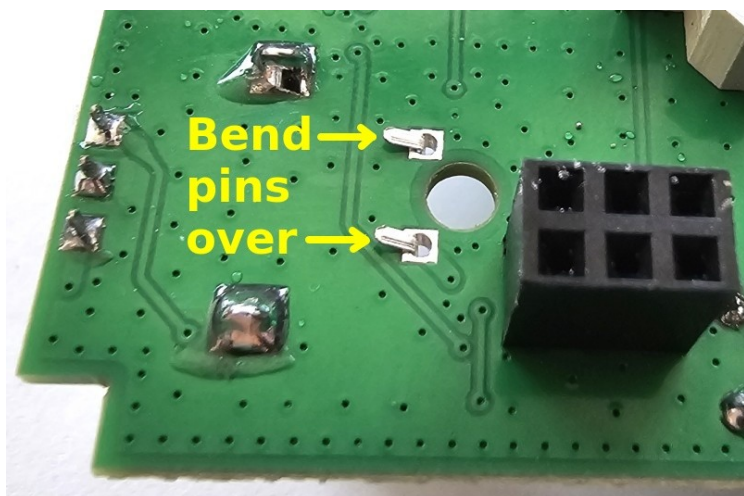

2.24 Assemble front panel and LCD

The following steps assume that you are installing the QMX+ in the optional enclosure. It's easier to complete this assembly BEFORE soldering the LCD module. If you are not going to install the QMX+ in the optional enclosure, then follow the same steps but without the aluminium front panel itself.

Step 1: Remove the protective film from the LCD module – it will be very hard to do this once the LCD is installed in the front panel.

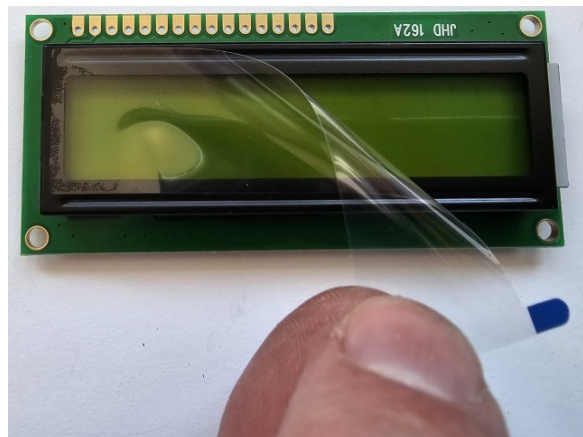

Step 2: First thread the 20mm black screws into the holes at the corner of the LCD cut-out, place the front panel face-down as shown, and screw on the 6mm nylon plastic spacers, but leave them loose, do not tighten them yet.

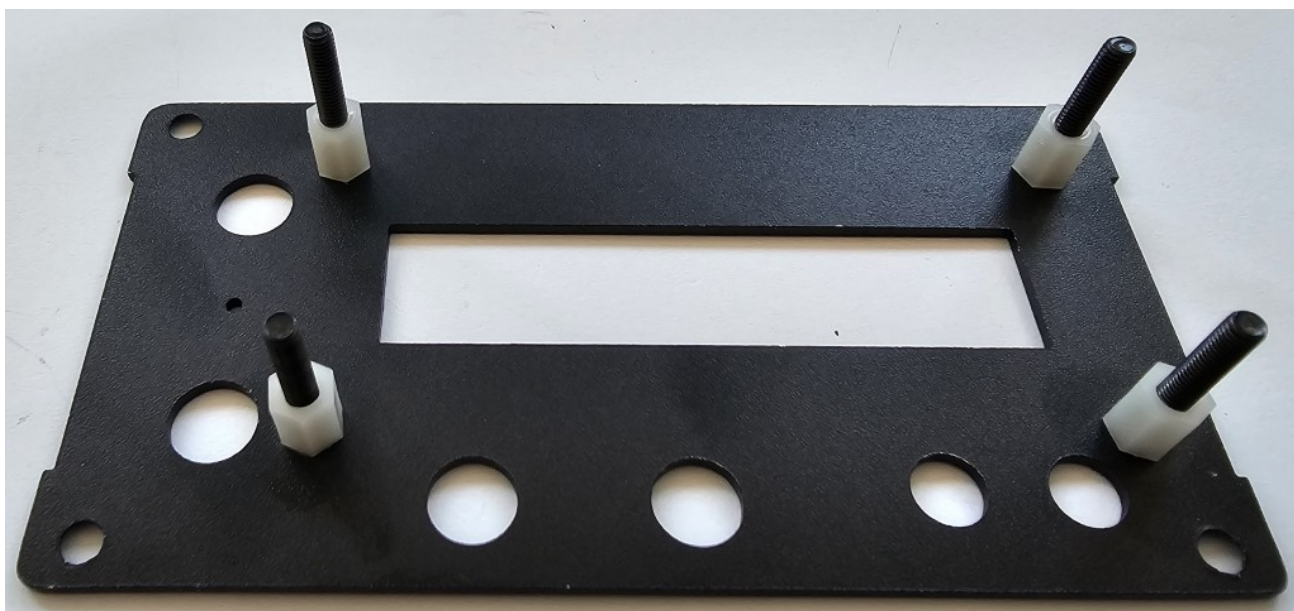

Step 3: Thread on the LCD module as shown. Note the orientation: the 16 connection pads are at the “top” edge of the front panel, therefore the silkscreen printing on the module is “upside down”.

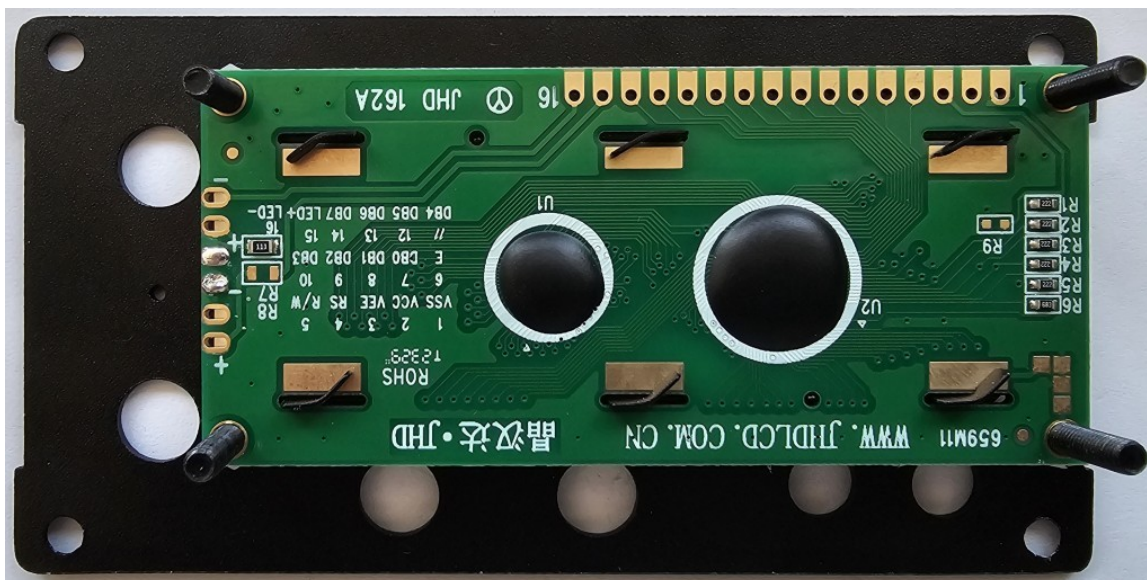

The holes in the LCD module are only just sufficiently large to accommodate the M3 (3mm) screw. It may be necessary to turn the screw with a screwdriver to encourage the screw through one or more of the holes. This is why you should not have tightened the 6mm spacers yet – if they are still loose, they can still turn.

When the LCD is securely in place, use needle-nose pliers to hold and tighten the four screws so that the 6mm spacer is secured.



Step 4: Add four nylon nuts to the four black screws and tighten them with the needle-nose pliers, as shown in the photograph.

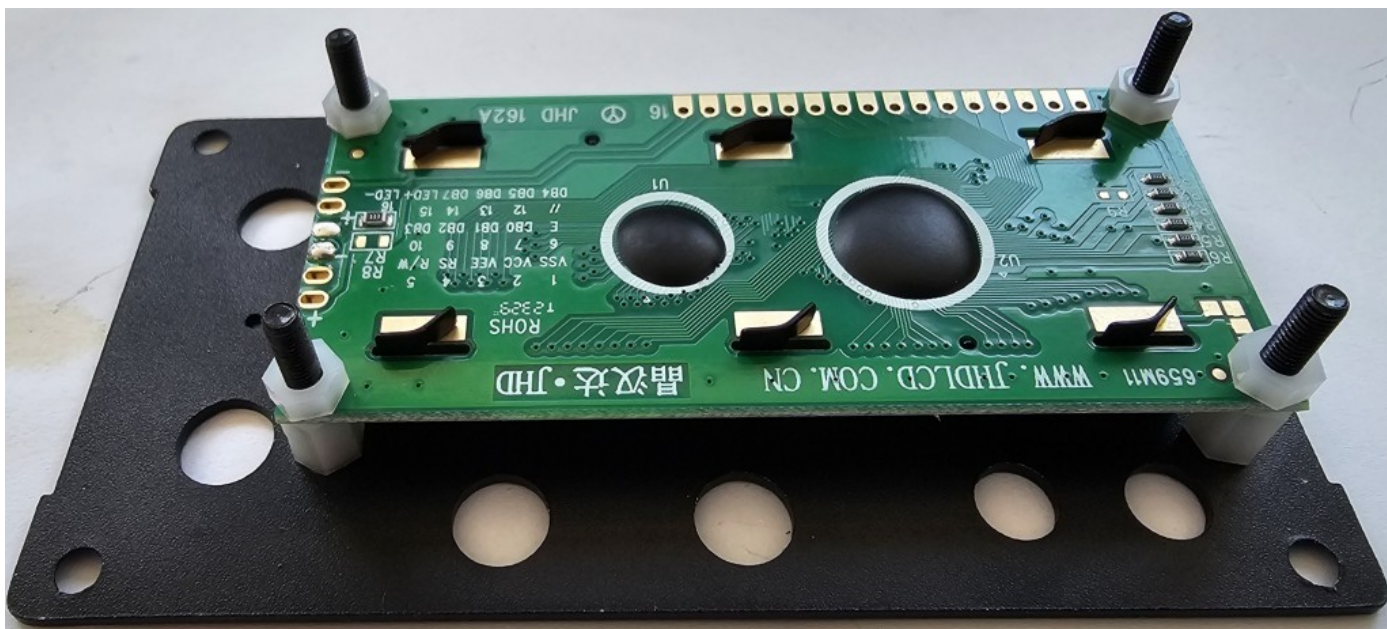

Step 5: Insert the 16-pin male pin header strip into the LCD module connector pads. The pin header has a short pin side and a long pin side. It will be easiest to insert the short pin side into the LCD module pads as shown.

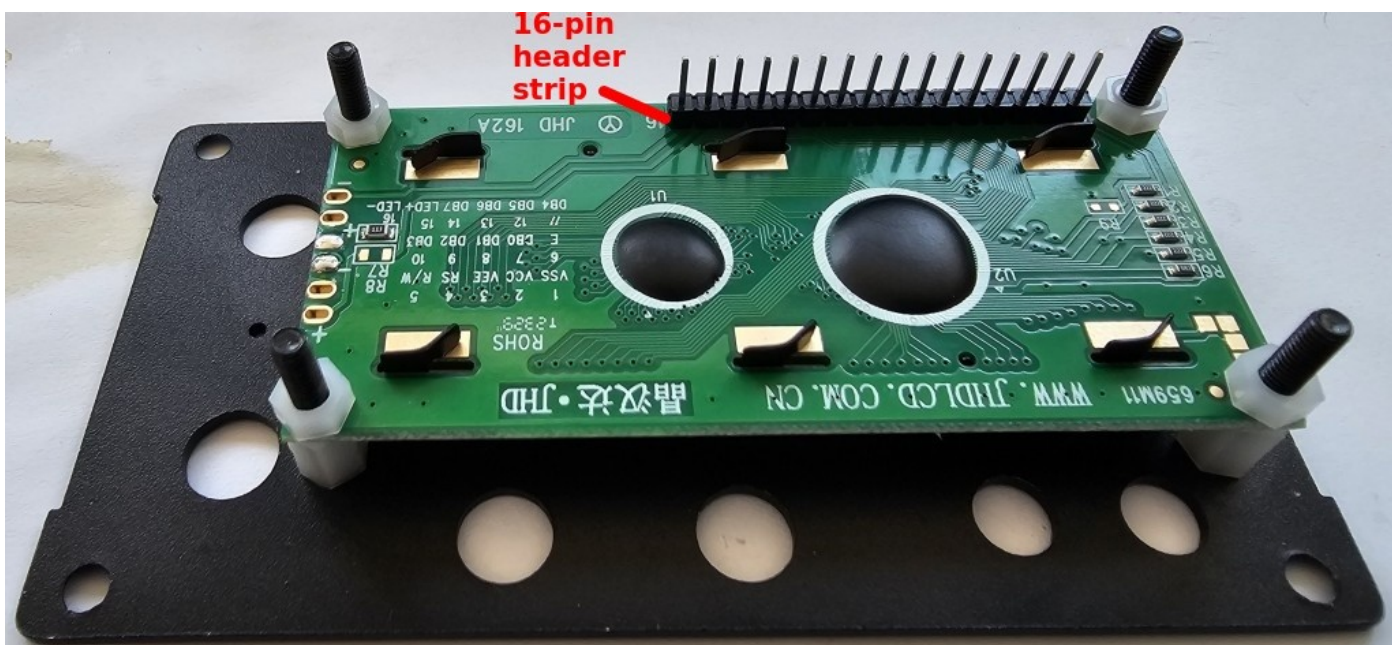

Step 6: Thread the front panel PCB onto the four screws as shown, taking care that the 16-pin header correctly goes into the LCD module on one side, and the main PCB on the other:

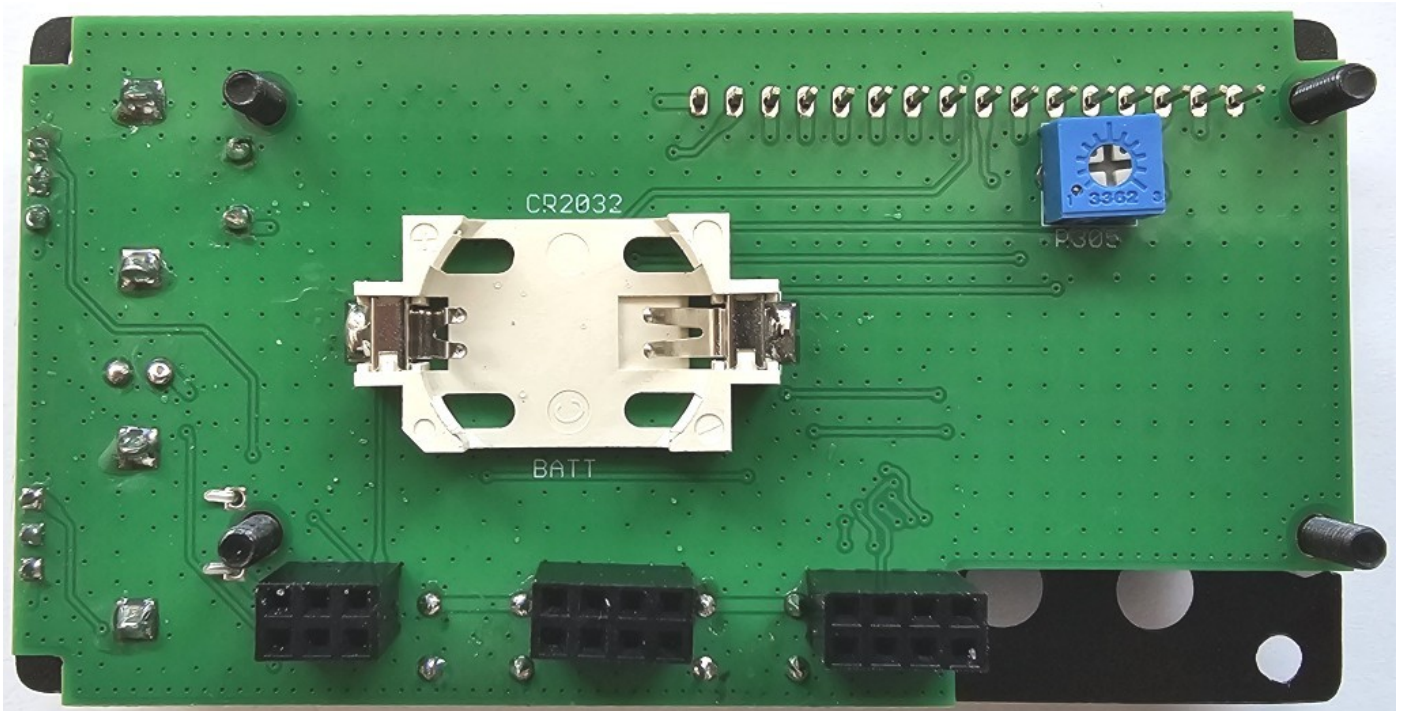

Step 7: Add four nylon nuts to the four black screws and tighten them with the needle nose pliers. Do not over tighten! It's only nylon, not your enemy's neck.

Tightening these nuts is very easy in three out of the four cases; the difficult one is the bottom left nut, whose hexagonal corners will interfere with the 2x3-pin header each 60-degrees of rotation. Persevere, is IS possible, just patiently tighten the nut 60-degrees at a time with the assistance of the needle nose pliers and you'll see it does work.

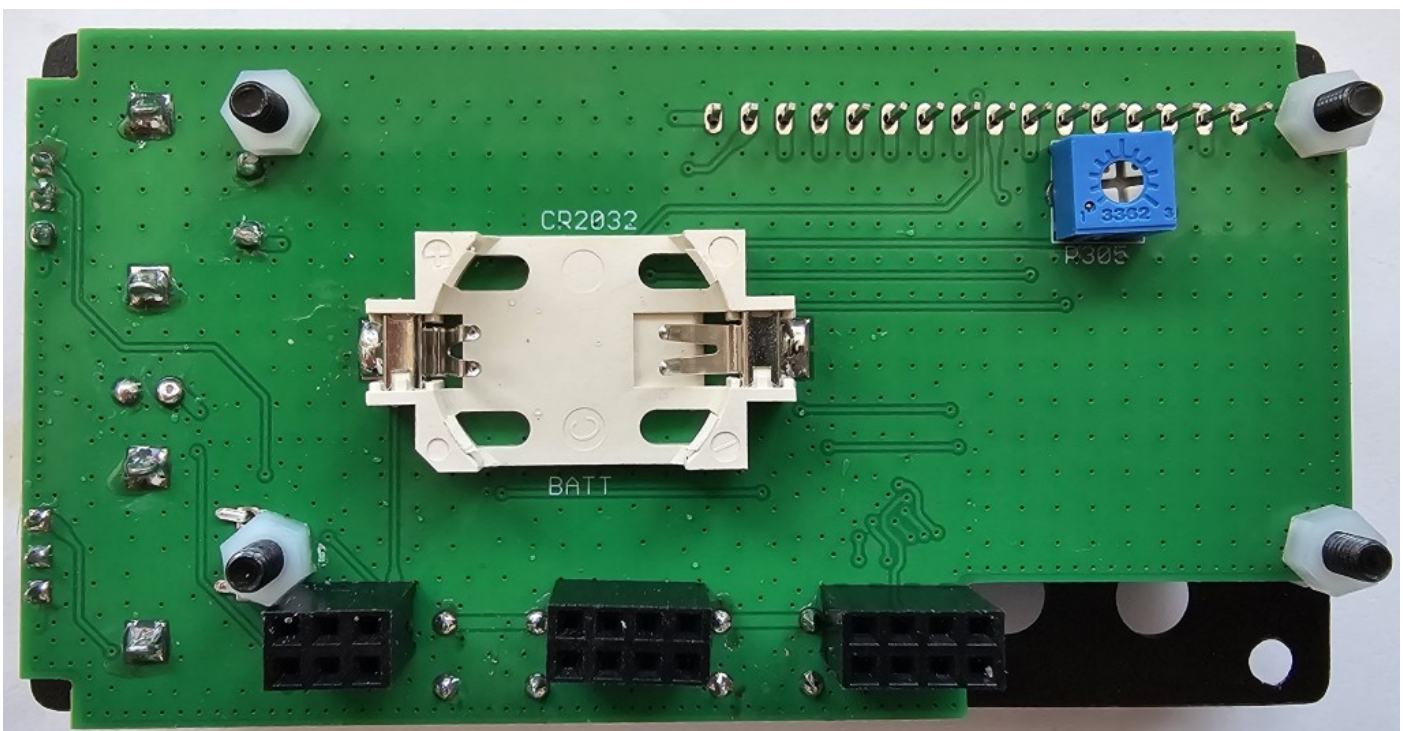

Step 8: Turn all the nuts and spacers on the two screws at the board edge shown below, such that the flats of the hexagonal spacers and nuts are parallel to the board edge. This will ensure that the nuts etc do not obstruct the front panel assembly when you are trying to fit it into the aluminium extrusion main body part of the housing.

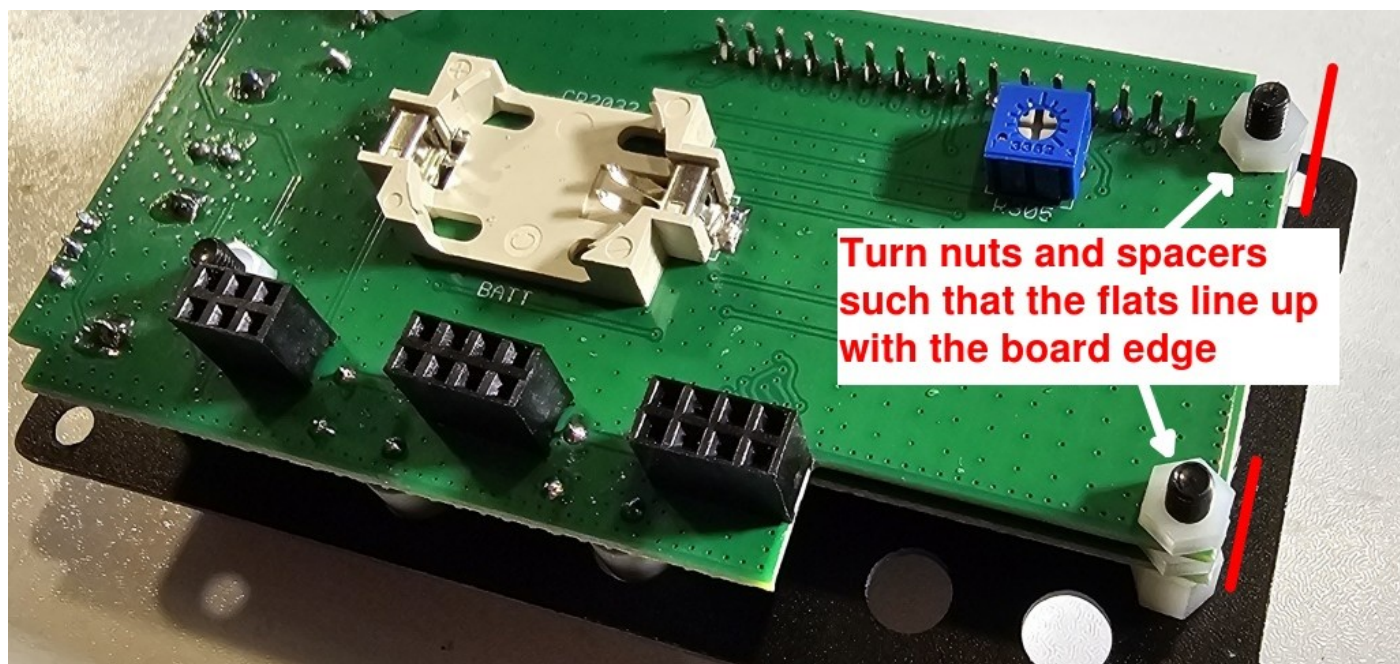

Step 9: Now you can solder the two unsoldered pins of the “Tune” rotary encoder. Relish the odor of molten nylon as you burn the plastic nut (in other words, please solder quickly – and try to avoid touching the plastic with the iron tip). For bonus points you may wish to use a DVM in continuity mode to check that the top pin is grounded (the mid pin of the opposite three is also ground), but there is NO continuity from the bottom pin to ground. If you have continuity to the bottom pin that means in your enthusiasm you may have scratched the soldermask of the groundplane.

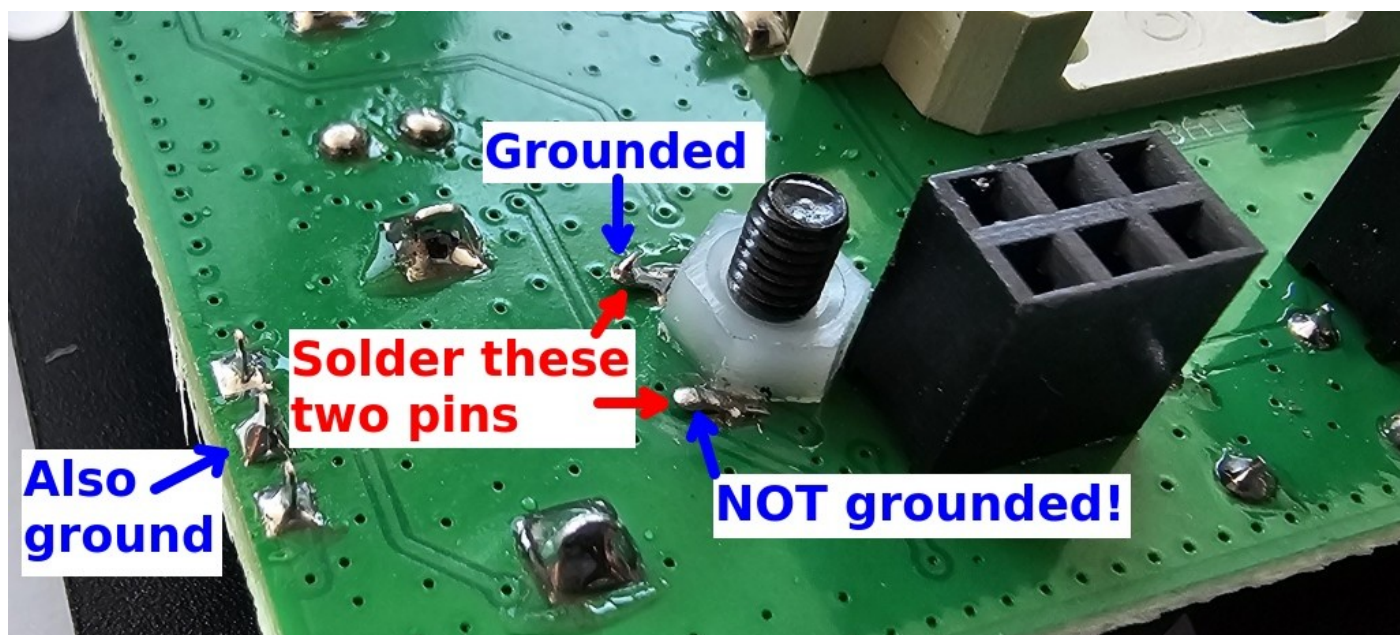

Step 10: Solder the 16 pins on the front side of the LCD module. Carefully. [Ed: it is accepted that the lack of a third hand is a design defect of homo-sapiens; an appropriate complaint has NOT been filed, you do want this to work in the end don't you].

The easiest way to solder each pin, despite the aluminium front panel definitely obscuring them, hold the tip of the iron pressing against the right hand side of each pin, while feeding in the solder from the left hand side; working your way from left to right through the 16 pins. This minimizes the chance of solder bridges. You can use a jeweller's loupe and good lighting at an appropriate angle, to inspect for any solder bridges. It goes without saying that solder bridges will definitely ruin your day.



Step 11: In what will now seem like a practically trivial step, complete the front panel assembly by soldering the remaining 16 pins of the LCD from the rear side of the front panel:

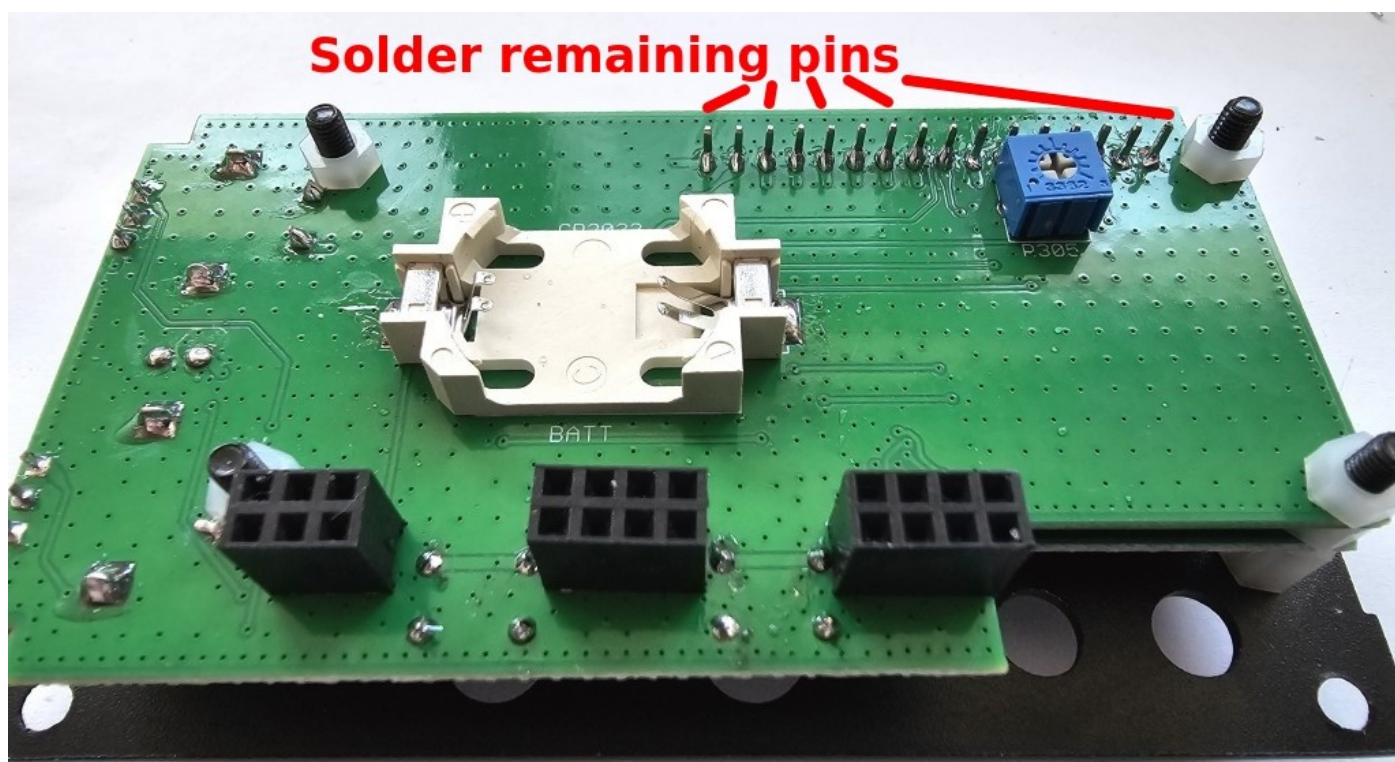

2.25 Add the button caps and knobs

You can now add the button caps, which should be firmly pushed onto the button shaft, and the knobs. The grub screw of the knobs will need to be somewhat undone before the knob will slide onto the rotary encoder shaft. Tighten the grub screw against the rounded part of the rotary encoder shaft, not the flat part.



2.26 Final enclosure assembly

If your rear PCB happens to be still fixed to the rear panel by the nut of the BNC connector, for the purposes of alignment, it will best to detach this now. This is because a certain amount of wiggling is likely required to put together the various sub-assemblies, and this is easiest WITHOUT the rear panel at this stage.

Step 1: Plug the front board assembly onto the main PCB. This is where the aforementioned wiggling comes in. You need to ensure that the 3.5mm front panel connectors (audio out, and paddle/mic) fit through the front panel holes; and that all three of the front panel's 2-row female pin header connectors are properly mated with their male counterparts on the main board. It does work, please wriggle carefully and patiently.

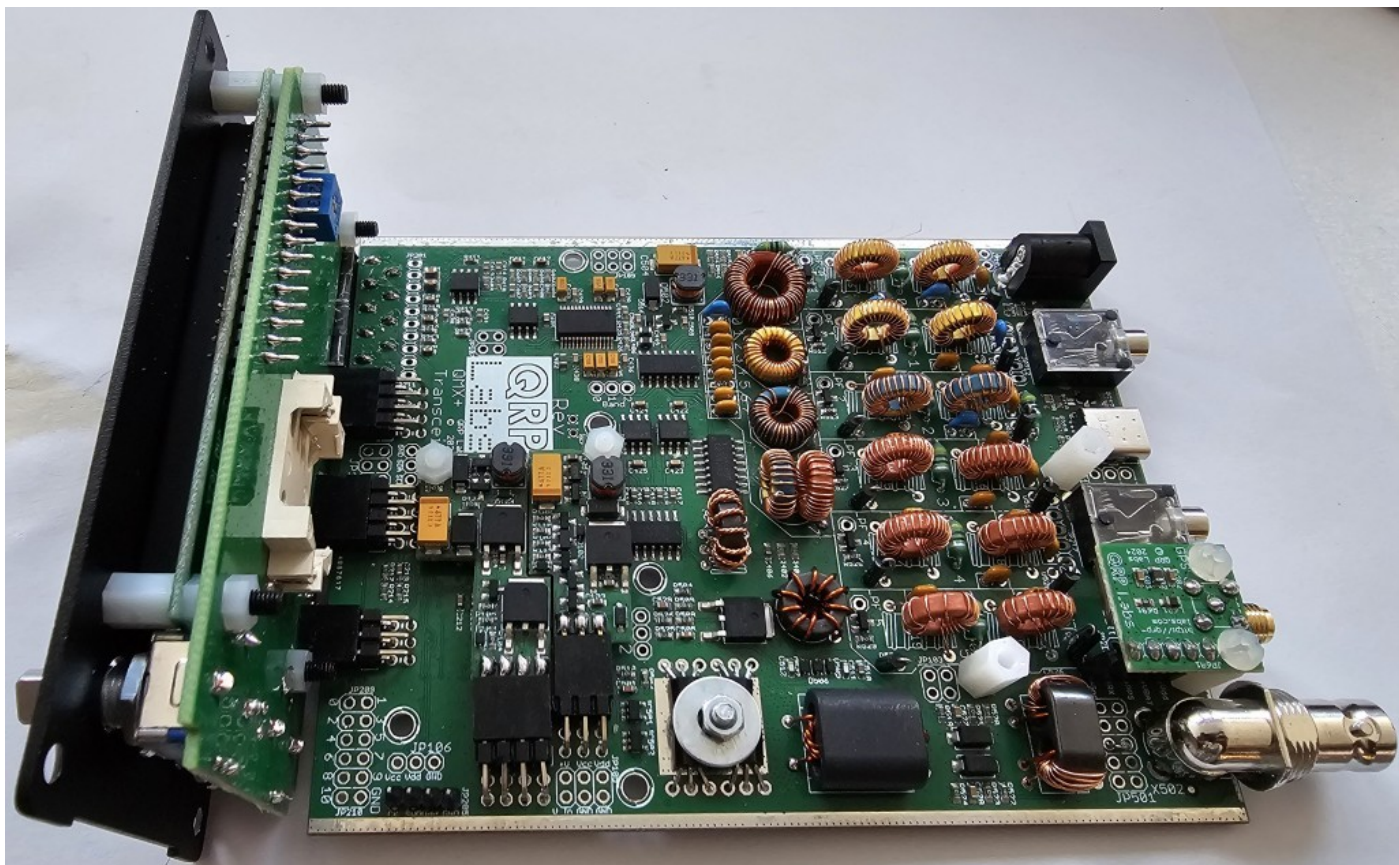

Step 2: Slide on one enclosure half, as shown in this photograph.

It should slide on easily without obstruction.

In the unlikely event of any unexpected resistance, check that you have trimmed all the component wires and pins on the underside. Oh in fact, check that ANYWAY.

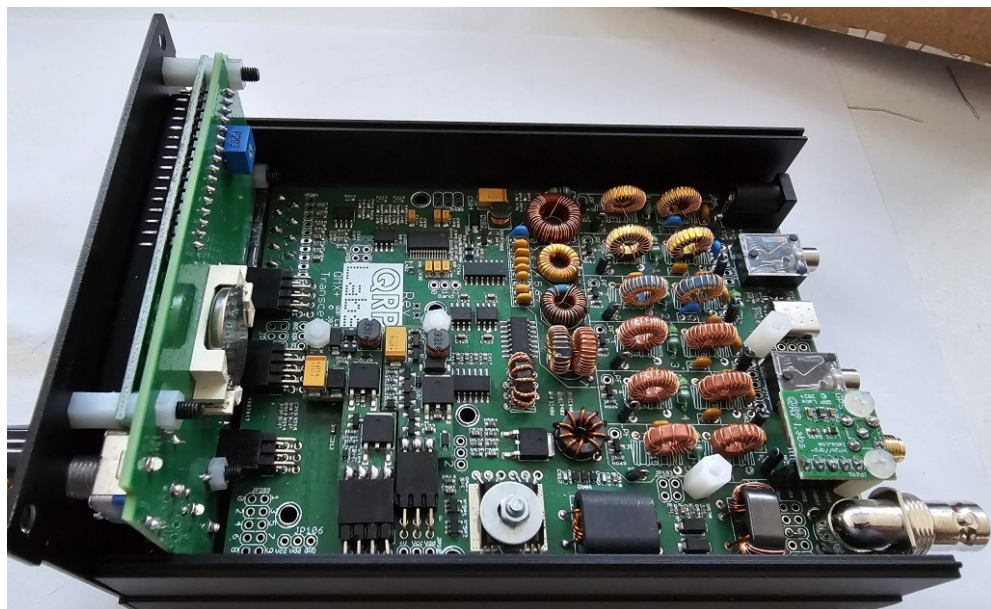

Step 3: Fix on the rear panel using the BNC connector nut:



Step 4: Remember: practically, you will want to power-up, make adjustments such as the LCD contrast trimmer, etc., BEFORE finally screwing together the case. But for completeness...

To finish the radio, add the top half of the enclosure; make sure it is the correct way round, remember the enclosure walls have a U-groove on one side and an I-tongue on the other. Then screw in the 8 enclosure fixing screws in the corners of the front and rear panels. Stick the four self-adhesive feet at appropriate locations in the corners of the enclosure bottom, on the FLAT part of the extrusion.



2.28 QMX+ front panel connections

The QMX+ front panel has two 3.5mm connectors, labeled “Ear” and “Mic/Paddle”.

The “Ear” connector is the audio output, intended to drive standard 32-ohm earphones, though many types of headphones will also be suitable.

The “Mic/Paddle” connector has dual purpose. A standard Morse paddle may be connected; if the “dit” and “dah” are not found to be the correct way round, don’t worry, there is a setting in the Keyer menu to swap them.

When a microphone is plugged in, the “ring” connection has a 2.2K pullup to +3.3V Vdd so is suitable for powering an Elecret microphone. The “tip” connection may be used as a grounded PTT (Push To Talk) input.

2.29 QMX+ rear panel connections



From Left-to right:

RF: The RF connector is the RF input/output port, at 50-ohms normally connected to a 50-ohm dummy load for testing or to your antenna system for operating. It may also be connected to an external amplifier if in use.

GPS interface: QMX+ has an internal GPS option called “QLG3”, which is supplied with an active patch magnetic mounted antenna with 2m of coaxial cable and an SMA connector. Unlike on the QMX, the serial data and PPS outputs of this internal module do NOT share the paddle inputs, so the module may be left connected all the time.

Alternatively if desired, an external GPS may be connected to the “Paddle” input on the front panel.

The QMX+ GPS interface can be used to:

- Calibrate the 25MHz TCXO reference oscillator
- Keep the oscillator disciplined and drift-free (frequency and time) during WSPR beacon operation
- Set the internal Real Time Clock, which is critical for WSPR options and may be displayed on-screen if you have configured it.

The GPS produces two output signals, PPS (Pulse-per-second) and RxD (Serial data). A GPS such as the QRP Labs QLG2 is perfect for use as an external GPS module (see <http://qrp-labs.com/qlg2>) or you may use the internal QLG3 module.

If using an external module, **QMX+ cannot supply +5V for the GPS unit; you need to provide that separately.** If using an external module, the GPS signals (PPS and RxD) use the same microcontroller pins as the paddle Dah and Dit respectively. Therefore you cannot use the Paddle and GPS at the same time. In fact, you should only connect the GPS during the calibration of the reference frequency, and while operating the QMX+ as a beacon (CW, FSKCW or WSPR).

The following diagram shows the connections.

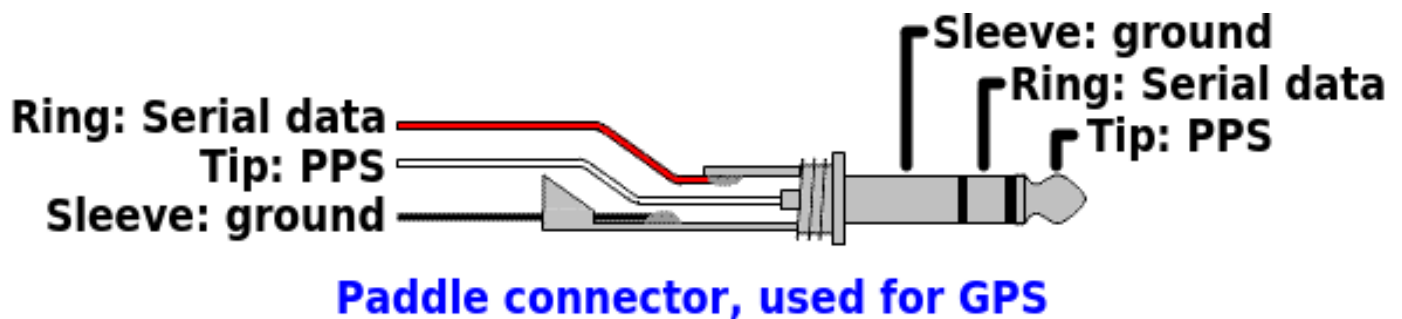

If using the internal QLG3 module, you do not need to worry about any external connections, and there is no conflict with the paddle “dit” and “dah” signals.

AUX: This is a multi-purpose 3.5mm stereo jack connector for future possible expansion. It can be configured with the “tip” and “ring as GPIO pins or as a serial port.

USB: This is a USB-C data port, which acts concurrently as both a high performance 24-bit stereo 48ksps USB sound card, and a USB Virtual COM Serial port. In the firmware update mode, the USB port functions as a USB Flash memory device.

Note that the USB port is NOT used for supplying power to QMX+. The power pins of the USB port are NOT connected. You can NOT connect a USB power bank via this port, for powering the QMX+.

PTT output: The QMX+ PCB has a 3.5mm stereo jack as PTT output.

The “Tip” connection is pulled to ground during transmit, when Q13 is switched on by the microcontroller.

The “Ring” connection is pulled to +5V during transmit when Q12 is switched on by the microcontroller.

A common standard 3.5mm stereo audio cable with 3.5mm plugs at each end may be used without modification between the QMX+ and the QRP Labs 50W PA (which uses the positive-going +5V signal on the “ring” and makes no connection to “tip”).

During transmit, the microcontroller activates ONE of the PTT signals; you may configure which one, according to your needs.

It should be noted that:

- The QRP Labs 50W PA may not be used in high duty cycle modes such as FT8, JS8 etc at full power. It should be de-rated to half power operation at maximum, by using a 12V or 13.8V supply. Caution is advised.
- The 50W PA kit has a built-in Low Pass Filter and is designed for single band operation only.
- The PTT output must be enabled per band, by connecting a terminal emulator to QMX+. Refer to the operation manual for details.

NOTE: the PTT output can also, via a simple hardware modification, be used as an additional serial port.

DC: The DC connector is a standard 2.1mm barrel connector with the center pin as positive.

WARNING:

QRP Labs recommends a maximum supply voltage of 12.0V for QMX+, which is particularly important when running high duty-cycle digital operations.

Do NOT use a battery with a nominal 12V voltage, which may in fact be much higher when fully charged.

Do NOT assume “nominal 12V” for some reason means a shack 13.8V supply may be used.

A convenient way to drop the voltage of higher supplies, is to use one or more 1A rectifier diodes such as from the 1N400x series, in series with the supply (no serious series pun intended), remembering that each diode will drop the voltage by approximately 0.6V.

2.30 FINAL CHECKS BEFORE APPLYING POWER THE FIRST TIME!

It's very highly recommended to check everything very carefully before applying power, as follows:

1. Look over the entire board with optical magnification and look for any dry joints, solder bridges or whiskers, components which were not soldered properly, etc.
2. Turn the contrast trimmer potentiometer on the display board (rear left) fully ANTI-clockwise initially; at the default adjustment there will be no text visible on the display!
3. Note that QMX+ is supplied with firmware, however it may not be the latest version so you are recommended to check for an install the latest firmware, to get the most out of your transceiver.
4. Make sure that the front panel connectors are properly soldered in and there are no shorts, and that the front panel board is installed correctly, all three 2-row pin header connectors correctly orientated and installed.
5. Be aware that the top rotary encoder shaft button (volume knob) must later be pressed (long press) to switch on the unit (see next section).
6. When you apply power to your QMX+ for the first time, it is a very good idea to use a lower supply voltage than you intend to run at, perhaps 7V for example; and use a current-limited supply if possible, perhaps limited to say 250mA. If there are any problems, this will minimize the probability of damage.
7. When you do finally dare to apply the power, you should see ZERO current consumption, and nothing happen; then press the top rotary encoder button; with a USB cable plugged in, QMX+ should appear the first time as a USB Flash drive (memory stick) so that you can install the firmware.

WARNING:

QRP Labs recommends a maximum supply voltage of 12.0V for QMX+, which is particularly important when running high duty-cycle digital operations.

Do NOT use a battery with a nominal 12V voltage, which may in fact be much higher when fully charged.

Do NOT assume "nominal 12V" for some reason means a shack 13.8V supply may be used.

A convenient way to drop the voltage of higher supplies, is to use one or more 1A rectifier diodes such as from the 1N400x series, in series with the supply (no serious series pun intended), remembering that each diode will drop the voltage by approximately 0.6V.

2.31 Connections for basic operation

The following connections are required for basic transceiver operation.

PLEASE READ PRECEDING SECTION before applying power.

1) Power supply

A power supply is required, which needs to be able to supply up to 1A approximately, on transmit. The supply voltage may be from 9V or 12V depending on how you wound the output transformer T501. If the voltages fall, the RF output will be correspondingly lower. Operation much above 5W output is not recommended and could lead to overheating and destruction of the final amplifier.

A 2.1mm DC connector plug is required; the center pin is + and the barrel is ground (negative).

WARNING:

QRP Labs recommends a maximum supply voltage of 12.0V for QMX+, which is particularly important when running high duty-cycle digital operations.

Do NOT use a battery with a nominal 12V voltage, which may in fact be much higher when fully charged.

Do NOT assume “nominal 12V” for some reason means a shack 13.8V supply may be used.

A convenient way to drop the voltage of higher supplies, is to use one or more 1A rectifier diodes such as from the 1N400x series, in series with the supply (no serious series pun intended), remembering that each diode will drop the voltage by approximately 0.6V.

2) Earphones

The earphones can be any stereo earphones such as commonly used with audio equipment, mobile phones and so on, with a 3.5mm stereo jack plug. These commonly have a 32-ohm impedance. The output op-amp IC (IC10) is not able to supply the required power output for loudspeakers.

If you want to use a small loudspeaker you will need to ensure this is an “amplified speaker” because the audio output will not be strong enough to drive a speaker directly.

3) Antenna system

The RF output is a filtered 50-ohm BNC output for connection to a usual antenna system (antenna, and matching unit if applicable).

4) Straight key or paddle

To operate the QMX+ transceiver a straight key or paddle should be connected to the appropriate jack, having a 3.5mm stereo jack plug. The shield (or main body) is ground. It does not really matter which way around the tip and ring connections are (to dit or dah of the paddle) since if they are the wrong way, there is a menu configuration item to swap them around. Similarly if using a straight key, you can select in the firmware either tip, ring or both for the connection; this allows use of a 3.5mm mono plug when using a straight key.

2.32 Updating the firmware

QMX+ requires firmware version 1_00_019 or above!

Note that QMX and QMX+ have the SAME firmware. There is no difference. Refer to the QMX page <http://qrp-labs.com/qmx> for details of the firmware updates. You must, on first power up (or after a factory reset) select the “QMX+ 160-6m” option so that the firmware will correctly initialize.

Your QMX+ is supplied with the bootloader installed, but not necessarily the latest firmware version. You are recommended to download and install the latest firmware version.

On occasion QRP Labs will make available updated firmware for QMX+, in order to deliver bug fixes or functionality enhancements. Firmware updates are always freely available to all QMX+ owners, and may be downloaded from the QMX+ web page <http://qrp-labs.com/QMX+>

QMX+ contains a the standard QRP Labs firmware update procedure for STM32-series microcontrollers, called QFU (QRP Labs **F**irmware **U**date) which provides the following features:

- **Easy** – anyone can do the firmware update
- **No additional hardware required:** only a standard USB-C cable
- **No additional software required:** just the standard file manager application that is already available on any PC
- **No drivers:** no special drivers need to be installed, the existing drivers on any modern PC operating system are used
- **Works on any PC Operating System:** and in the same way: Windows, Linux, Mac
- **Secure:** firmware files are published on the QRP Labs website and are encrypted using 256-bit AES encryption technology

Entering bootloader (firmware update) mode:

Note: you have to switch on QMX+ by pressing the left rotary encoder shaft button! In firmware update mode, the LCD is blank and the backlight is off.

QMX+ provides three possible ways to enter firmware update mode:

1. Select the “Update firmware” option in the QMX+ in the “Other” sub-menu of the configuration menu system on the QMX+ itself.
2. Select the “Update firmware” menu option in the QMX+ Terminal (refer to operating manual). QMX+ will then enter firmware update mode.
3. Connect a wire jumper from Aux2 to Ground (see details below) to force firmware update mode.

Exiting bootloader (firmware update) mode:

QMX+ provides two possible ways to exit firmware update mode:

- 1) Update the firmware! After updating the firmware, QMX+ will automatically reboot in normal operating mode.
- 2) Power down QMX+, and re-apply the power again. QMX+ will reboot in normal operating mode (as long as a valid firmware file has been installed, at least the first time you use QMX+).

USB Flash memory stick emulation:

In the firmware update mode, the QMX+ pretends to be a USB Flash memory stick, having a 4MByte capacity and implementing a FAT16 file system. This virtual “Flash stick” contains two files:

1. the firmware program file of the QMX+ microcontroller. You may read the file from QMX+, or write a new one, just by dragging files in your file manager application.
2. EEPROM contents: the QMX+ configuration and log file (if enabled). Again, you can read the file from QMX+ or write a new one to QMX+, simply by dragging files in your file manager application.

On entering the Firmware update procedure, a pop-up window should appear on your PC. On my system (Linux XUbuntu 18.04) it looks like this:

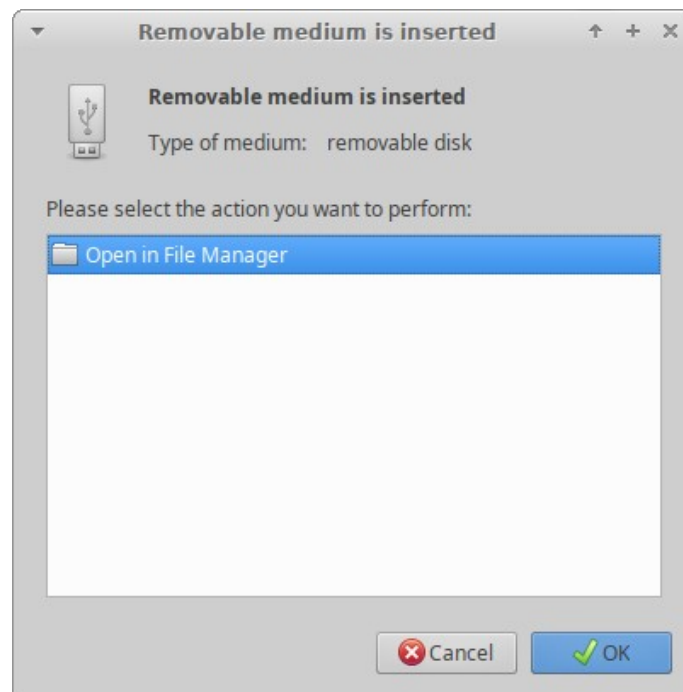

Click the OK button.

The File Manager window will then open, and on my system looks like the screenshot on the following page.

QMX+ appears as a removable USB Flash device named “QMX+”, and the folder two files. The firmware file in this example is named shows a single file which is the firmware version file, 1_00.QMX+ in this example. The EEPROM file is always named EEPROM. You can read and write EEPROM files in order to make and restore backup copies of your configuration etc.

The firmware file name must not be longer than 8 characters, and cannot contain punctuation or spaces; the file extension must be no more than 3 characters. This is because the file system emulation is FAT16 and these are the specifications of the FAT16 format.

You may check the properties of the file and will note that it is a 529 KBytes file.

QMX+ firmware images are always a 529K file. The creation date and modification date etc. have not been set, because it was important to minimize the size and complexity of the QFU bootloader, in order to maximize the space available to the application firmware.

You may copy the existing firmware file to another directory of your computer. Crucially, to do the firmware update, all you need to do is copy the new firmware file to this QMX+ “Flash disk”.

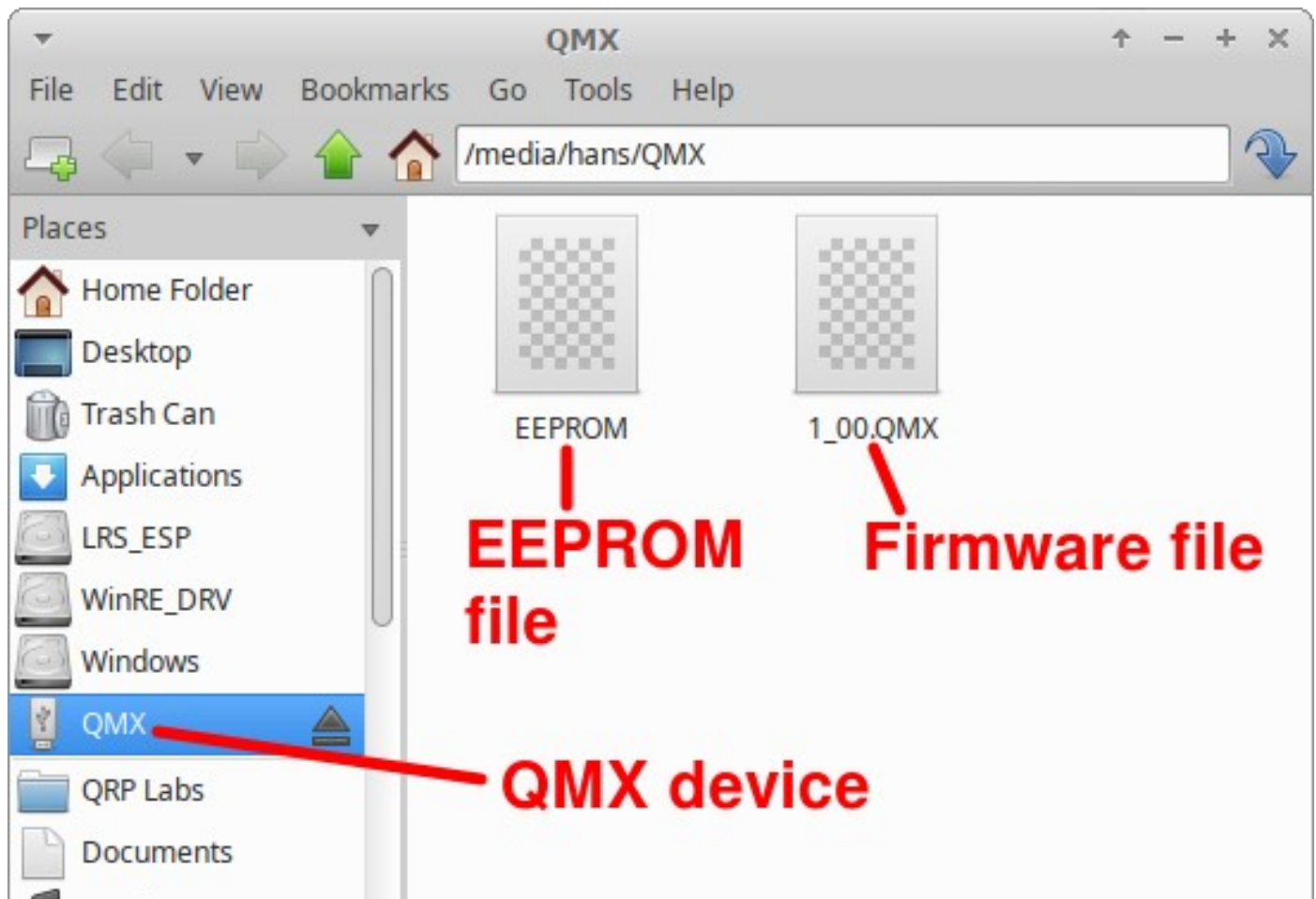

Download the new firmware file from the QRP Labs website at <http://qrp-labs.com/QMX+>, unzip it, and simply drag it into the folder where the existing firmware file version is shown. Or copy and paste it, however you wish.

The file on the QRP Labs website is a ZIPPED file, please be sure to unzip it to get the .QMX+ file before copying it to QMX+.

As soon as you copy the new file to the QMX+ QFU “flash drive”, the QMX+ QFU bootloader erases the current program from its memory and installs the new one.

The QMX+ firmware is 256-bit AES encrypted and this means:

- The encrypted QMX+ firmware file will only work on a QRP Labs QMX+ board, it cannot be installed on any other board, even one containing the same processor.
- No other firmware file will work on the QRP Labs QMX+ board except an official QRP Labs encrypted QMX+ firmware file.

The procedure will vary slightly for different Operating systems but in all cases is just a simple matter of copying the new firmware file to the emulated QMX+ QFU USB Flash drive.

On booting up for the first time, the QMX+ screen contrast adjustment will be required; QMX+ will then ask you for your choice of version, use the right-hand rotary encoder to select “QMX+ 160-6m” then press the left button to select it. If you chose the wrong version, you can always get back to this selection using by executing a Factory Reset. Please refer to the operating manual for further details.

The above firmware update procedure works on ANY modern OS because the QFU bootloader emulates a USB Flash memory stick with the USB Mass Storage Device (MSD) class, for which drivers are already present.

The QFU bootloader implements a USB device stack (Mass Storage Device class), emulated FAT16 file system, Flash erase/write, and 256-AES encryption.

Forcing firmware update mode using wire jumpers

If for any reason, the firmware update did not execute correctly, you cannot access either the user interface on the QMX+ or log in via the terminal, and you need to force the unit to re-enter firmware update mode – you can do this by connecting a wire jumper from the Aux 2 pin to Ground (see diagram below) then re-starting QMX+ (cycle the power supply voltage). QMX+ will remain in bootloader mode until you remove the wire link.

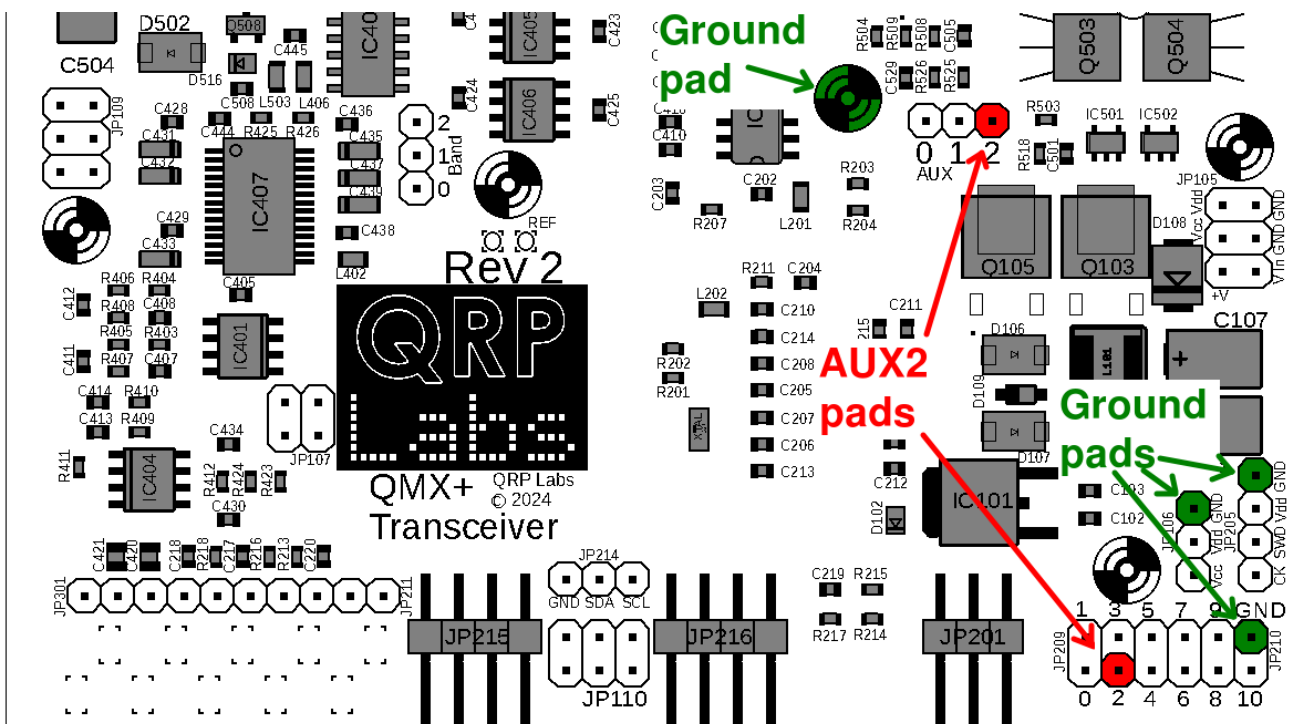

3. QLG3 GPS option

The QLG3 is an internal GPS module option specifically designed for the QMX+. The GPS module itself is E108, the same as used on the general purpose QLG2 module. However this minimalist QLG3 PCB for the QMX+ contains no logic level conversion, indicators, voltage regulator, or USB-Serial converter.

Installation in the QMX+ is very simple and the QLG3 GPS can be left connected permanently because unlike a GPS connected via the paddle port, there are no conflicts with any other signals.

The QLG3 board is installed at the rear right hand corner of the QMX+ PCB next to the BNC connector.

CAUTION:

All components are installed from the “bottom” side of the QLG3 board, which is the side with the RF module on it. Soldering is done on the “top” side.

Step 1: Solder the 1x5-pin female header socket to the main QMX+ PCB. Ensure it is standing vertically with respect to the board. As usual solder one pin first, then re-check.

Step 2: Solder the 1x5-pin male header plug to the QLG3 PCB, with the plug pins on the E108 module side of the board (“bottom” side), and soldering on the side with the small SMD components (“top” side).

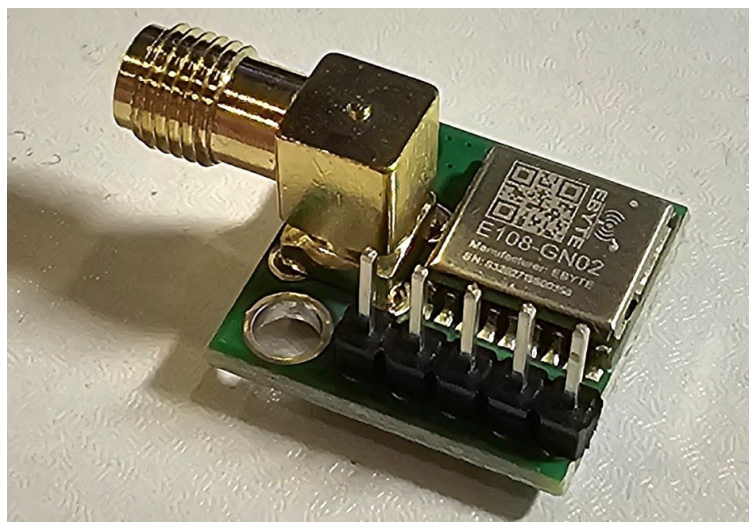
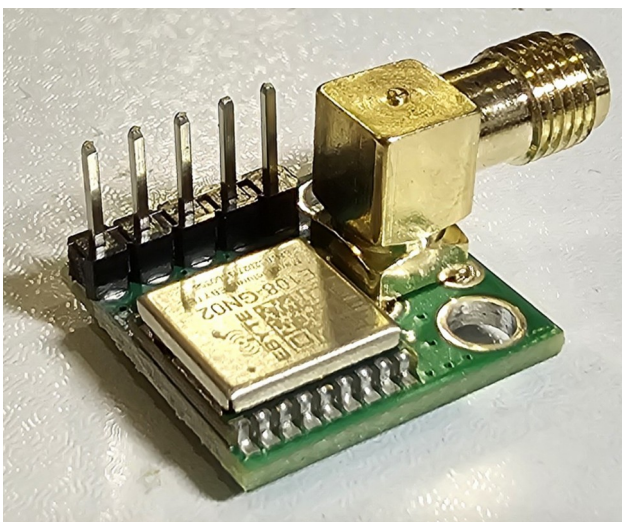
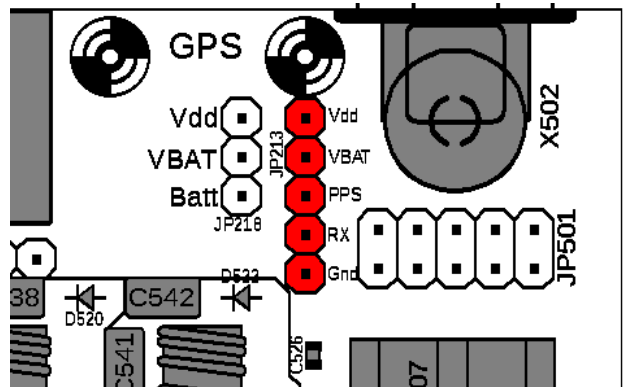
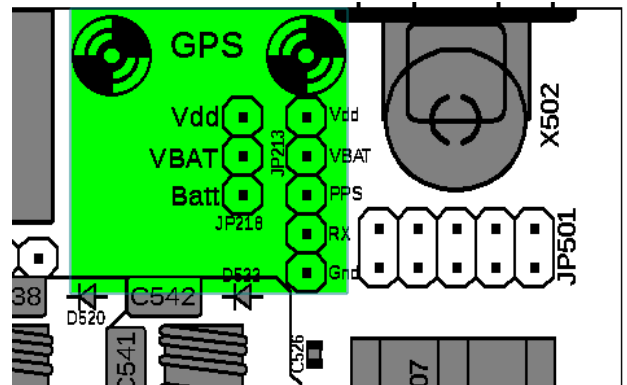

Hopefully these photographs make the assembly procedure clear.

Step 3: Solder on the 90-degree header connector. However, accurate alignment is very important here. If you seat the SMA connector firmly in the PCB holes and solder it exactly square, everything will be fine. OR, to do this step you should plug the module into the main QMX+ board and attach the rear panel, thereby ensuring correct alignment.

Step 4: Mount the two 11mm hex nylon spacers on the main QMX+ PCB, using a 6mm nylon screw tightened from the bottom side of the main QMX+ PCB.

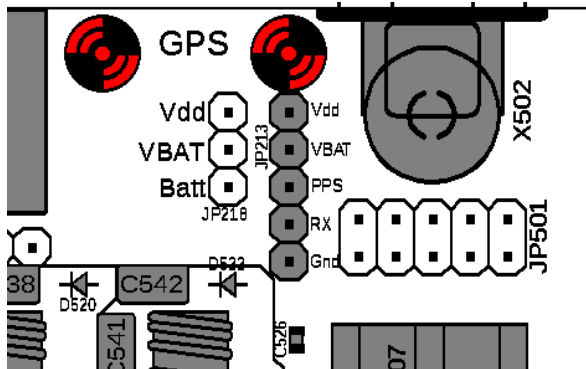

Step 5: Crucially, the VBAT pin of the E108 module needs to be powered; there are two options:

- 1) Power it from the normal +3.3V Vdd supply rail.
- 2) Power it from the CR2032 coin cell battery (which must then be installed).

Option 2 has the advantage that the E108 module will retain downloaded satellite ephemeris so it will achieve satellite lock faster, if it has been switched off for only a short time (a few hours). Since most people are not likely to need a few seconds faster lock, I would suggest if unsure, choose option #1.

This diagram shows option 1 selected, by connecting VBAT to Vdd.

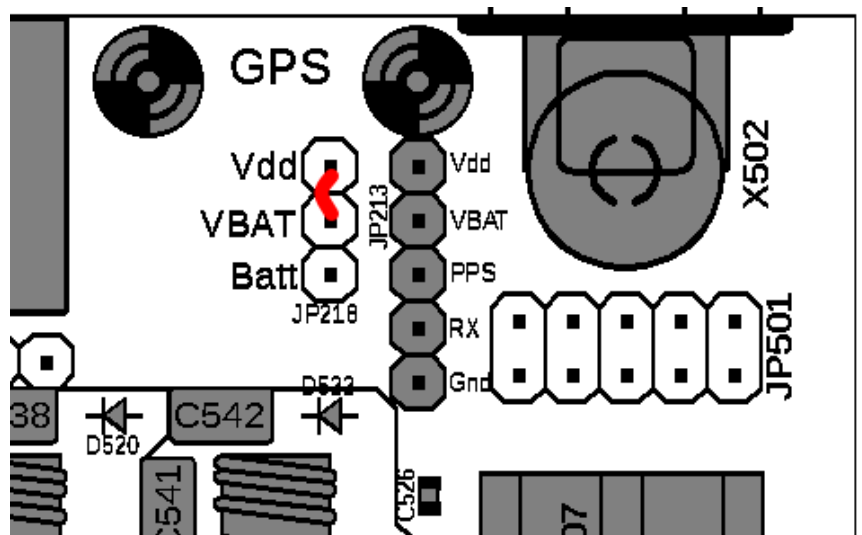

For option 2, you would connect VBAT to Batt instead.

WARNING: the jumper wire must sit flush down on the board. Otherwise it will short with the metal body of the SMA connector!

Step 6: Plug the module into the main QMX+ PCB and secure it using the remaining two 6mm screws as shown.

Step 7: In the configuration menu of QMX+, in the System menu, "GPS source" must be set to "QMX+ Internal" in order to read data from the QLG3 instead of an external GPS connected to the paddle port.

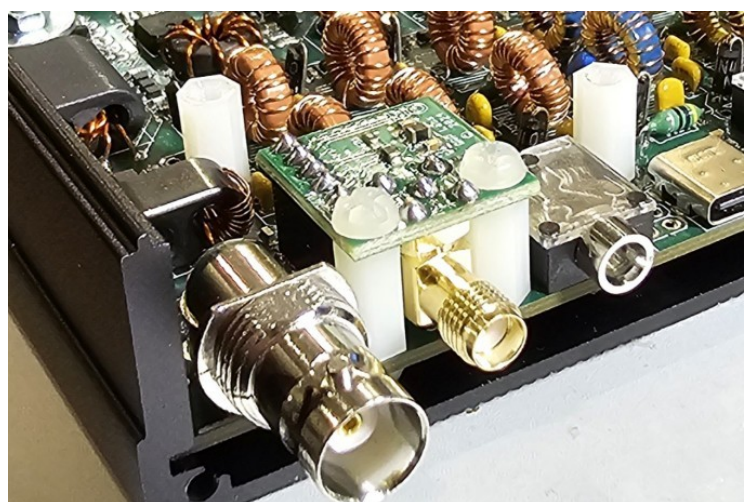

4. Dev kit option

The Dev kit consists of a matrix board, four 11mm nylon hex spacers, and 8 M3 6mm screws. The screws and spacers may be used with any four of the available 7 holes on the main QMX PCB to mount the Dev board 11mm above the main QMX+ board. This is sufficient clearance for all parts on the main QMX+ board. It is also the right height for male/female pin headers if you wish to make connections between the main PCB and Dev PCB (pin headers are available from the QRP Labs shop spare parts section).

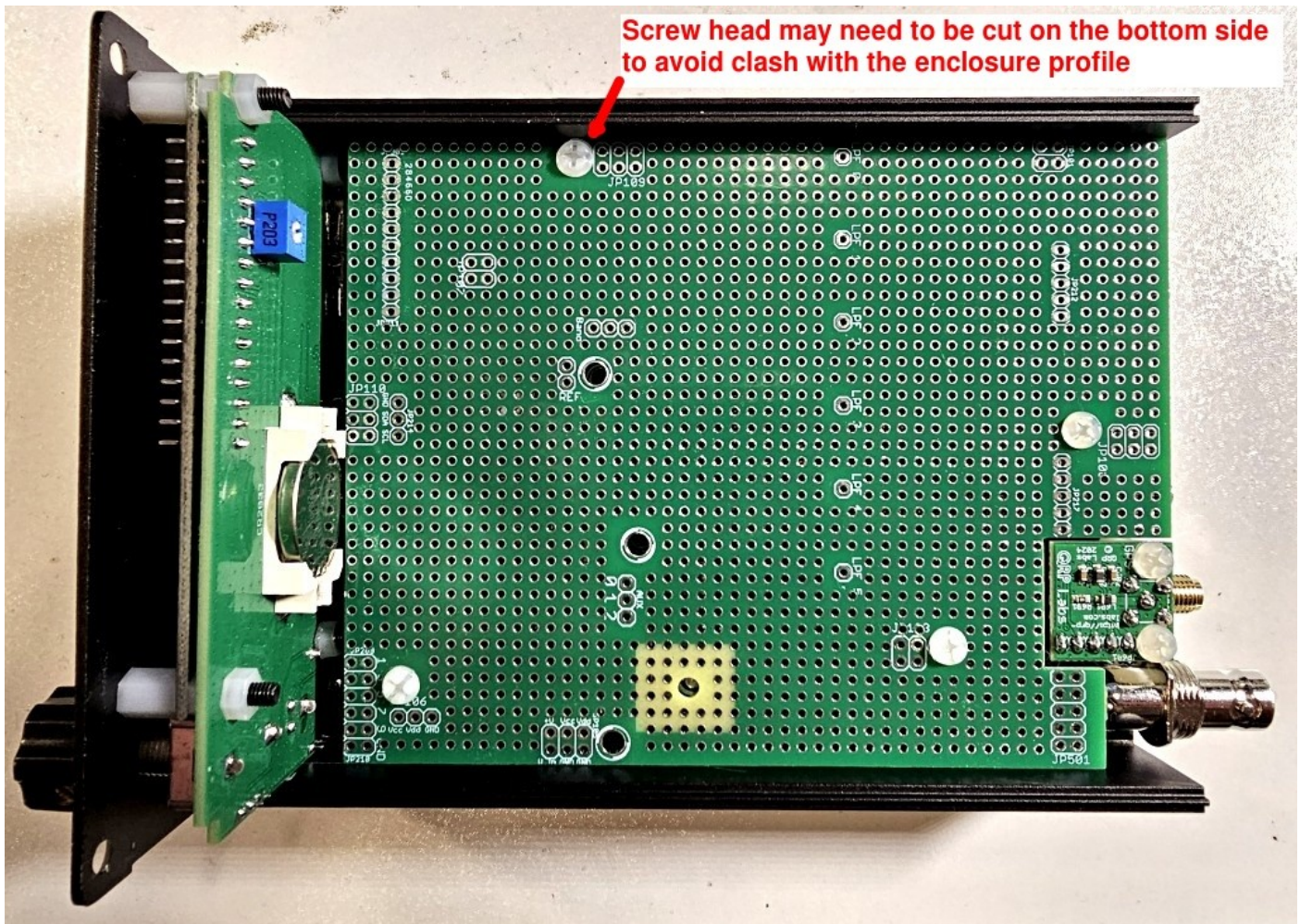

A number of signals are made available on the main PCB that may be simply connected to the Dev PCB via pin headers:

- 11 GPIO pins labeled 0 to 10
- 0V, 3.3V (Vdd) and 5V (Vcc) rails – see warning below
- Vin/V+ supply voltage, both before and after the QMX+ Soft-switch / Reverse polarity protection
- I2C bus signals (SDA, SCL)
- Band0, Band1, Band2 BPF select signals
- 6 signals for LPF selection, LPF 0 to LPF 5
- 5 pins for each 3.5mm jack (Audio out, Paddle/Mic, PTT out, AUX) for tip/ring and switched pins
- RF Out, which may be intercepted for example, to install an Auto-ATU module
- One 2x2-pin and three 2x4-pin headers not connected to anything (for your mods)
- Ref input pin (if you want to disconnect the 25MHz TCXO and use your own external reference)

WARNING: Incorrect use of the 3.3V (Vdd) and 5V (Vcc) rails could damage your QMX+ irreversibly. You should not connect anything to these pins unless you know what you're doing (which means, nothing should draw any appreciable current from these pins).

5. Resources

- For updates and tips relating to this kit please visit the QRP Labs QMX+ kit page <http://qrp-labs.com/QMX+>
- For any questions regarding the assembly and operation of this kit please join the QRP Labs group, see <http://qrp-labs.com/group> for details

6. Document Revision History

1.00	16-May-2024	First official version
1.01	09-Jul-2024	Fixed some errors in section 2.30 referring to left button (thanks Chris W3PB)
2.00	20-Aug-2024	IC101 incorrectly called 78M05, it should be 78M33 Document version amended for PCB Rev 2
2.01	03-Jan-2025	Update for T37-10 toroids for some LPFs